



Dialogic[®] Host Media Processing Software for Windows[®]

Configuration Guide

August 2010

Copyright and Legal Notice

Copyright © 2002-2010, Dialogic Corporation. All rights reserved. You may not reproduce this document in whole or in part without permission in writing from Dialogic Corporation.

All contents of this document are furnished for informational use only and are subject to change without notice and do not represent a commitment on the part of Dialogic Corporation or its subsidiaries ("Dialogic"). Reasonable effort is made to ensure the accuracy of the information contained in the document. However, Dialogic does not warrant the accuracy of this information and cannot accept responsibility for errors, inaccuracies or omissions that may be contained in this document.

INFORMATION IN THIS DOCUMENT IS PROVIDED IN CONNECTION WITH DIALOGIC® PRODUCTS. NO LICENSE, EXPRESS OR IMPLIED, BY ESTOPPEL OR OTHERWISE, TO ANY INTELLECTUAL PROPERTY RIGHTS IS GRANTED BY THIS DOCUMENT. EXCEPT AS PROVIDED IN A SIGNED AGREEMENT BETWEEN YOU AND DIALOGIC, DIALOGIC ASSUMES NO LIABILITY WHATSOEVER, AND DIALOGIC DISCLAIMS ANY EXPRESS OR IMPLIED WARRANTY, RELATING TO SALE AND/OR USE OF DIALOGIC PRODUCTS INCLUDING LIABILITY OR WARRANTIES RELATING TO FITNESS FOR A PARTICULAR PURPOSE, MERCHANTABILITY, OR INFRINGEMENT OF ANY INTELLECTUAL PROPERTY RIGHT OF A THIRD PARTY.

Dialogic products are not intended for use in medical, life saving, life sustaining, critical control or safety systems, or in nuclear facility applications.

Due to differing national regulations and approval requirements, certain Dialogic products may be suitable for use only in specific countries, and thus may not function properly in other countries. You are responsible for ensuring that your use of such products occurs only in the countries where such use is suitable. For information on specific products, contact Dialogic Corporation at the address indicated below or on the web at www.dialogic.com.

It is possible that the use or implementation of any one of the concepts, applications, or ideas described in this document, in marketing collateral produced by or on web pages maintained by Dialogic may infringe one or more patents or other intellectual property rights owned by third parties. Dialogic does not provide any intellectual property licenses with the sale of Dialogic products other than a license to use such product in accordance with intellectual property owned or validly licensed by Dialogic and no such licenses are provided except pursuant to a signed agreement with Dialogic. More detailed information about such intellectual property is available from Dialogic's legal department at 9800 Cavendish Blvd., 5th Floor, Montreal, Quebec, Canada H4M 2V9. **Dialogic encourages all users of its products to procure all necessary intellectual property licenses required to implement any concepts or applications and does not condone or encourage any intellectual property infringement and disclaims any responsibility related thereto. These intellectual property licenses may differ from country to country and it is the responsibility of those who develop the concepts or applications to be aware of and comply with different national license requirements.**

Any use case(s) shown and/or described herein represent one or more examples of the various ways, scenarios or environments in which Dialogic® products can be used. Such use case(s) are non-limiting and do not represent recommendations of Dialogic as to whether or how to use Dialogic products.

Dialogic, Dialogic Pro, Brooktrout, Diva, Diva ISDN, Making Innovation Thrive, Video is the New Voice, Diastar, Cantata, TruFax, SwitchKit, SnowShore, Eicon, Eicon Networks, NMS Communications, NMS (stylized), Eiconcard, SIPcontrol, TrustedVideo, Exnet, EXS, Connecting to Growth, Fusion, Vision, PacketMedia, PowerMedia, NaturalAccess, NaturalCallControl, NaturalConference, NaturalFax and Shiva, among others as well as related logos, are either registered trademarks or trademarks of Dialogic Corporation or its subsidiaries. Dialogic's trademarks may be used publicly only with permission from Dialogic. Such permission may only be granted by Dialogic's legal department at 9800 Cavendish Blvd., 5th Floor, Montreal, Quebec, Canada H4M 2V9. Any authorized use of Dialogic's trademarks will be subject to full respect of the trademark guidelines published by Dialogic from time to time and any use of Dialogic's trademarks requires proper acknowledgement.

Microsoft and Windows are registered trademarks of Microsoft Corporation in the United States and/or other countries. Other names of actual companies and products mentioned herein are the trademarks of their respective owners.

Publication Date: August 2010

Document Number: 05-2518-002

Contents

	Revision History	7
	About This Publication	9
	Purpose	9
	Applicability	9
	Intended Audience	9
	How to Use This Publication	10
	Related Information	10
1	Configuration Overview	11
	1.1 Major Configuration Steps	11
	1.2 The Configuration Process	11
2	Feature Support by Platform	14
3	Dialogic® Configuration Manager (DCM) Details	15
	3.1 Dialogic® Configuration Manager (DCM)	15
	3.1.1 TDM Bus Parameters	17
	3.1.2 Bridge Device Parameters	19
	3.1.3 Bridge Controller Parameters	20
	3.2 Configuration File Sets	21
	3.3 Media Loads	22
	3.3.1 Features Supported	22
	3.4 CT Bus (TDM) Clocking	23
	3.4.1 Primary Clock Fallback	23
	3.5 Dialogic® HMP Software Clocking and Fallback	24
4	Configuration Procedures	26
	4.1 Assumptions and Prerequisites	26
	4.2 Order of Procedures	27
	4.3 Starting the Dialogic® Configuration Manager (DCM)	28
	4.4 Configuring Dialogic® HMP Interface Boards	29
	4.4.1 Selecting a Configuration File Set	29
	4.4.2 Setting the TDM Bus Clock Source	31
	4.4.3 Setting the Bus Companding Method	32
	4.4.4 Modifying Bridge Device Parameters	33
	4.4.5 Modifying Bridge Controller Parameters	34
	4.4.6 Configuring the Global Call CDP File	35
	4.5 Modifying Other DCM Property Sheet Parameters	35
	4.6 Modifying the FCD File Parameters	36
	4.6.1 Editing the CONFIG File	37
	4.6.2 Generating the FCD File	37
	4.7 Initializing the System	38
	4.8 Reconfiguring the System	38
	4.9 Preserving Data in User Configuration Files	39

Contents

5	Echo Cancellation	41
5.1	Echo Cancellation Background Information	41
5.1.1	Overview	41
5.1.2	Acoustic Echo	42
5.1.3	Electrical Echo	42
5.2	Echo Cancellation Features	43
5.3	Using Echo Cancellation	44
5.4	Configuring Host-Based Echo Cancellation	45
5.4.1	Echo Cancellation on IP Media Devices	45
5.4.2	Echo Cancellation on Voice Devices	46
5.4.3	Echo Cancellation on Conferencing Devices	47
5.4.4	Echo Cancellation on CSP/Voice Devices	48
5.5	Host-Based Echo Cancellation Sample Scenarios	49
5.5.1	DTI and IP Gateway Example	49
5.5.2	DTI and IP Conferencing Example	49
5.5.3	DTI and CSP/Voice Example	50
5.5.4	DTI and Voice Example	50
5.5.5	IP and IP Connection Example	51
5.5.6	IP and CSP/Voice Example	51
5.5.7	IP and Voice Example	51
5.6	Configuring On-Board Echo Cancellation	52
6	Dialogic® Configuration Manager (DCM) Parameter Reference	54
6.1	Bridge Controller Property Sheet	54
6.2	Bridge Device Configuration Property Sheet	55
6.3	Driver Property Sheet	59
6.4	Logical Property Sheet	61
6.5	Misc Property Sheet	61
6.6	Physical Property Sheet	65
6.7	TDM Bus Configuration Property Sheet	70
6.8	Trunk Configuration Property Sheet	79
6.9	Version (Version Info.) Property Sheet	81
7	CONFIG File Details	83
7.1	CONFIG File Formatting Conventions	83
7.2	CONFIG File Sections	84
7.3	[Encoder] Section	85
7.4	[NFAS] Section	86
7.5	[CHP] Section	87
7.6	[TSC] Section	88
8	CONFIG File Parameter Reference for Dialogic® HMP Software	89
8.1	[0x2c] Echo Cancellation Parameters	89
8.2	[encoder] Parameters	91
8.3	[0x3b] Conferencing Parameters	94
8.4	[IPVSC] IP Media Parameters	97
8.5	[decoder] Speed Control Parameter	101
8.6	[sigDef] Parameters	101
9	CONFIG File Parameter Reference for Dialogic® HMP Interface Boards	103

9.1	[0x2c] Echo Cancellation Parameters	104
9.2	[lineAdmin.x] Parameters	105
9.3	[NFAS] Parameters	113
9.4	[NFAS.x] Parameters	114
9.5	[CCS] Parameters	116
9.6	[CHP] Parameters	121
9.7	[CHP] ISDN Protocol Variant Definitions	122
9.8	[TSC] Parameters	130
9.9	[TSC] defineBSet Parameters	130
9.10	[sigDet] Parameters	137
	Glossary	138
	Index	145

Figures

1	DCM Main Window	16
2	Misc Property Sheet	17
3	TDM Bus Configuration Property Sheet	18
4	Bridge Device Configuration Property Sheet	20
5	Bridge Controller Property Sheet	21
6	Clock Fallback	24
7	Computer Name Dialog Box	28
8	Assign Firmware File Dialog Box	31
9	Physical Property Sheet	36
10	Electrical Echo and the Hybrid	42
11	T1/E1 Gateway Example	49
12	DTI and IP Conferencing Example	50
13	DTI and CSP/Voice Example	50
14	DTI and Voice Example	50
15	IP and IP Connection Example	51
16	IP and CSP/Voice Example	51
17	IP and Voice Example	51
18	AGC Gain vs. Input Average	85

Revision History

This revision history summarizes the changes made in each published version of this document.

Document No.	Publication Date	Description of Revisions
05-2518-002	August 2010	<p>Made global changes to reflect Dialogic brand. Changed title to “Dialogic® Host Media Processing Software for Windows® Configuration Guide.”</p> <p>Removed all information related to Dialogic® Digital Station Interface (DSI) Boards, as these boards are no longer supported.</p> <p>Configuration Overview chapter: Updated to identify configuration steps for Dialogic® HMP Software and configuration steps for Dialogic® HMP Interface Boards (DNI Boards).</p> <p>Feature Support by Platform chapter: New.</p> <p>Dialogic® Configuration Manager (DCM) Details chapter: Updated examples in Configuration File Sets. Added DNI Boards (PCIe) in Media Loads.</p> <p>CONFIG File Details chapter: Added [Encoder] Section to support SCR feature.</p> <p>Configuration Procedures chapter: Updated to identify configuration steps for Dialogic® HMP Software and configuration steps for DNI Boards. Added Preserving Data in User Configuration Files section.</p> <p>Echo Cancellation chapter: Added Configuring On-Board Echo Cancellation section. Added CNF conferencing in Echo Cancellation on Conferencing Devices.</p> <p>Dialogic® Configuration Manager (DCM) Parameter Reference chapter: Updated Trunk Configuration Property Sheet section: added E1CAS and DASS2 protocol support; added DNI Boards (PCIe); added Trunk 5 through Trunk 8. Throughout the chapter, removed all parameters used by the DSI Boards, as these boards are no longer supported.</p> <p>CONFIG File Parameter Reference for Dialogic® HMP Software chapter: Updated [0x2c] Echo Cancellation Parameters to cover DNI Boards (PCIe). Added [encoder] Parameters, which consists of SCR parameters (AEnc_ and RM_ISCR). Added parameters in [0x3b] Conferencing Parameters: NotifyAddToneLevel, NotifyAddToneFreq, and NotifyAddToneLength. Updated [IPVSC] IP Media Parameters section: added RTP Source Filter; for Latency parameters, updated number of frames buffered (replaced “1.5 times” with “2 times”).</p>

Revision History

Document No.	Publication Date	Description of Revisions
05-2518-001	August 2006	<p>Initial version of document. Much of the information contained in this document was previously published in the <i>Digital Network Interface Boards Configuration Guide</i>, document number 05-2474-002.</p> <p>Following are changes made since document number 05-2474-002:</p> <p>Global change: Added Digital Station Interface boards to the document. Information in this document applies to both digital network interface boards and digital station interface boards unless otherwise noted.</p> <p>DCM Parameter Reference chapter: In the Misc Property Sheet section, added Device State parameter description. In the Physical Property Sheet section, added DriverBoardID, PhysicalID, PhysicalSlot, Model, ModelNumber, and NumPorts parameter descriptions. Added Telephony Interface Property Sheet and its parameter descriptions. In the Trunk Configuration Property Sheet section, revised Group 2 Protocol Values to indicate support for DPNSS.</p> <p>CONFIG File Parameter Reference for Dialogic® Digital Network Interface Boards chapter: New title to specify that information is for digital network interface boards. Added [sigDet] Parameters section to cover PAMD/PVD qualification templates.</p> <p>CONFIG File Parameter Reference for Dialogic® HMP Software chapter: New. Describes parameters associated with the HMP software.</p> <p>Glossary: Added definition for non-linear processing (NLP).</p>

About This Publication

The following topics provide information about this software configuration guide:

- [Purpose](#)
- [Applicability](#)
- [Intended Audience](#)
- [How to Use This Publication](#)
- [Related Information](#)

Purpose

This guide provides information about configuring Dialogic® Host Media Processing (HMP) Software and Dialogic® HMP Interface Boards (also referred to herein as “DNI Boards”) in a Windows® system. Configuration procedures are included, as well as descriptions of configuration files and configuration parameters.

Note: This guide does not apply to Dialogic® Springware Architecture PCIe boards that are supported in the Dialogic® HMP Software release. For information about configuring Springware Architecture PCIe boards such as the D/80PCIE-LS, see the *Dialogic® Springware Architecture Products Configuration Guide*.

Applicability

This document is published for Dialogic® Host Media Processing (HMP) Software Release 3.0WIN Service Update.

This document may also be applicable to other Dialogic® Host Media Processing Software releases. Check the release guide for your software release to determine if this document is supported.

Intended Audience

This information is intended for system, application, and technology developers; toolkit vendors; VAR/system integrators; system and network administrators.

How to Use This Publication

This information is organized as follows:

- [Chapter 1, “Configuration Overview”](#) describes the major configuration steps in the order in which they are performed and provides a brief overview of configuring a system containing DNI Boards.
- [Chapter 2, “Feature Support by Platform”](#) describes high-level feature support by platform.
- [Chapter 3, “Dialogic® Configuration Manager \(DCM\) Details”](#) provides details about using the Dialogic® Configuration Manager (DCM), selecting configuration files and setting configuration parameters.
- [Chapter 4, “Configuration Procedures”](#) contains detailed procedural information for configuring an HMP Software system that may include DNI Boards.
- [Chapter 5, “Echo Cancellation”](#) describes echo cancellation support in Dialogic® HMP Software and on DNI Boards. Background echo cancellation information and configuration information are included.
- [Chapter 6, “Dialogic® Configuration Manager \(DCM\) Parameter Reference”](#) describes each parameter associated with the DCM. Included are a description, a list of values, and configuration guidelines.
- [Chapter 7, “CONFIG File Details”](#) provides additional detailed information about specific aspects of configuring a system that relate to the `.config` (CONFIG) files.
- [Chapter 8, “CONFIG File Parameter Reference for Dialogic® HMP Software”](#), describes parameters in the HMP CONFIG file associated with the Dialogic® HMP Software. Included are a description, a list of values, and configuration guidelines.
- [Chapter 9, “CONFIG File Parameter Reference for Dialogic® HMP Interface Boards”](#) describes parameters in the CONFIG files associated with the DNI Boards. Included are a description, a list of values, and configuration guidelines.

Related Information

See the following for additional information:

- <http://www.dialogic.com/manuals/> (for Dialogic® product documentation)
- <http://www.dialogic.com/support/> (for Dialogic Technical Services and Support)
- <http://www.dialogic.com/> (for Dialogic® product information)
- For timely information that may affect configuration, see the Release Guide and Release Update. Be sure to check the Release Update for the software release you are using for any updates or corrections to this publication. Release Updates are available on the Dialogic Web site at: <http://www.dialogic.com/manuals/hmp30win/default.htm>

The configuration overview describes the major configuration steps in the order in which they are performed. It also provides a brief overview of each aspect of configuring a system containing Dialogic® HMP Interface Boards that have a digital network interface (also referred to herein as “DNI Boards”).

- [Major Configuration Steps](#) 11
- [The Configuration Process](#) 11

Note: This guide does not apply to Dialogic® Springware Architecture PCIe boards. For information about configuring Dialogic® Springware Architecture PCIe boards, such as the D/80PCIE-LS, see the *Dialogic® Springware Architecture Products Configuration Guide*.

1.1 Major Configuration Steps

The following major steps are used to configure a system running Dialogic® Host Media Processing (HMP) Software with optional DNI Boards:

1. Starting the configuration manager utility, Dialogic® Configuration Manager (DCM) (required)
2. Understanding configuration file sets
3. For DNI Boards, these additional procedures are applicable:
 - a. Setting the TDM bus clock source
 - b. Modifying bridge device parameters
 - c. Modifying bridge controller parameters
4. Setting up echo cancellation
5. Modifying other DCM property sheet parameters
6. Modifying FCD parameters
7. Initializing the system (required)
8. Reconfiguring the system
9. Preserving user configuration data

1.2 The Configuration Process

Once the Dialogic® HMP Software is installed and the appropriate licensing is obtained, you start the configuration process by invoking DCM. The configuration parameters that you select in the DCM are used by the downloader to initialize the system when the boards are started. For detailed procedures, see [Chapter 4, “Configuration Procedures”](#).

Configuration Overview

An overview of the configuration process is follows:

Starting the DCM utility

Within the DCM, each board has a set of property sheets that display the board's configuration parameters, grouped together on tabs according to the type of board functionality they affect (for example, the Driver tab). For details about the DCM, including property sheets and parameters, see the DCM Online Help, [Chapter 3, "Dialogic® Configuration Manager \(DCM\) Details"](#), and [Chapter 6, "Dialogic® Configuration Manager \(DCM\) Parameter Reference"](#).

Understanding configuration file sets

Two configuration files, a Product Configuration Description (PCD) file and a Feature Configuration Description (FCD) file, are downloaded to the HMP Software system and to each DNI Board, if present, in your system. For HMP Software, the files are downloaded according to the license type, while for DNI Boards, the files are downloaded according to the board type and the protocol that the board will use. For more information, see [Section 3.2, "Configuration File Sets"](#), on page 21, [Section 4.4.1, "Selecting a Configuration File Set"](#), on page 29, and [Section 4.9, "Preserving Data in User Configuration Files"](#), on page 39.

Setting the TDM Bus

For DNI Boards, use the DCM to access the TDM Bus Configuration property sheet. Modify the clock source as needed. The source for clocking depends on the bus mode in which the system runs. The bus mode is determined by the capability of the devices installed in your system. The system automatically determines the bus mode on the basis of installed devices. For more information, see [Section 4.4.2, "Setting the TDM Bus Clock Source"](#), on page 31 and [Section 4.4.3, "Setting the Bus Companding Method"](#), on page 32.

Modifying bridge device parameters

For DNI Boards, use the DCM to access the Bridge Device Configuration property sheet to configure the bridge device. DNI boards have a bridge device that enables communication and media streaming between Dialogic® HMP Software and the boards on the CT Bus. The media stream connections are managed by the bridge controller. For more information, see [Section 3.1.2, "Bridge Device Parameters"](#), on page 19 and [Section 4.4.4, "Modifying Bridge Device Parameters"](#), on page 33.

Modifying bridge controller parameters

For DNI Boards, use the DCM to access the Bridge Controller property sheet to configure the bridge controller. DNI boards have a bridge device that enables communication and media streaming between Dialogic® HMP Software and the boards on the CT Bus. The media stream connections are managed by the bridge controller. For more information, see [Section 3.1.3, "Bridge Controller Parameters"](#), on page 20 and [Section 4.4.5, "Modifying Bridge Controller Parameters"](#), on page 34.

Setting up echo cancellation

This step applies when DNI Boards are present in the system. Echo cancellation is typically required when HMP devices (for example, IP media, voice, and conferencing) receive media streams from the public switched telephone network (PSTN) via the DTI devices on these boards. Certain DNI Boards, such as the Dialogic® DNI/310TEPEHMP, DNI/610TEPEHMP, DNI/1210TEPEHMP, and DNI/2410TEPEHMP boards, provide on-board echo cancellation. For details about setting up echo cancellation on these devices or alternatively on the HMP Software, see [Chapter 5, "Echo Cancellation"](#).

Modifying other DCM property sheet parameters

Modify additional DCM parameters as needed. For details about DCM property sheets and associated parameters, see the DCM Online Help or [Chapter 6, “Dialogic® Configuration Manager \(DCM\) Parameter Reference”](#).

Modifying FCD file parameters

It is sometimes necessary to adjust the parameters within the FCD file; this is done by editing the associated CONFIG file. The files in a configuration file set (*.pcd*, *.fcd*, and *.config* files) are located in the *data* directory under INTEL_DIALOGIC_DIR, the environment variable for the directory in which the software is installed. For details about configuration file sets, refer to [Section 3.2, “Configuration File Sets”](#), on page 21 and [Section 4.9, “Preserving Data in User Configuration Files”](#), on page 39. For details about CONFIG files, refer to [Chapter 7, “CONFIG File Details”](#).

Initializing the system

During system initialization, all required firmware for a board is downloaded and configured using the identified configuration files and parameter settings. For more information, see [Section 4.7, “Initializing the System”](#), on page 38.

Reconfiguring a system

If hardware is added or configuration parameters need to be changed, you must reconfigure the system. Stop system service using the configuration manager utility (DCM); then make parameter changes as needed. The system is then re-initialized by starting the system service. For more information, see [Section 4.8, “Reconfiguring the System”](#), on page 38.

Preserving user configuration data

Configuration settings unique to your environment can be preserved and re-applied whenever a Dialogic® HMP Software license is changed or reactivated. For more information, see [Section 4.9, “Preserving Data in User Configuration Files”](#), on page 39.

Feature Support by Platform

2

This chapter lists the high-level features supported by the Dialogic® platform (software release).

Table 1. High-Level Feature Support by Platform

Feature / Board	Dialogic® HMP Software 3.0WIN	Comments
Dialogic® HMP Interface Boards (Universal PCI): DNI/300TEPHMP, DNI/601TEPHMP, DNI/1200TEPHMP	S	For media load information, see Section 3.3, “Media Loads” , on page 22. DNI/601TEPHMP has on-board echo cancellation. The other boards use host-based echo cancellation.
Dialogic® HMP Interface Boards (PCI Express): DNI/310TEPEHMP, DNI/610TEPEHMP, DNI/1210TEPEHMP, DNI/2410TEPEHMP	S	For media load information, see Section 3.3, “Media Loads” , on page 22. These boards have on-board echo cancellation.
MSML	S	
PSTN Network Interface protocols	S	Supported via Dialogic® HMP Interface Boards. R2MF is supported on DNI/601TEPHMP only.
Transparent data routing	S	Exception: not supported on DNI/601TEPHMP (Universal PCI).
User configuration file (<i>HMP.Uconfig</i>)	S	Exception: not supported on Dialogic® HMP Interface Boards.
Legend: S = supported; NS = not supported Dialogic® HMP Software 3.0WIN = Dialogic® Host Media Processing Software Release 3.0WIN		

Dialogic® Configuration Manager (DCM) Details

3

This chapter describes the Dialogic® Configuration Manager (DCM) graphical user interface including information to help you select configuration files.

- Dialogic® Configuration Manager (DCM) 15
- Configuration File Sets 21
- Media Loads 22
- CT Bus (TDM) Clocking 23
- Dialogic® HMP Software Clocking and Fallback 24

3.1 Dialogic® Configuration Manager (DCM)

The DCM utility is a graphical user interface (GUI) that allows you to customize board, system, and TDM bus configurations. The interface is used to modify parameter settings, select different configuration file sets, start and stop the system, and start and stop individual boards. In addition, the DCM can start the system using the default configuration settings.

The DCM main window contains pull-down menus, shortcut icons, a system window, and a status window. The system window contains a tree structure of the boards installed in your system. The top line of the display, Configured Devices on..., shows the name of the computer you are connected to. If you entered an IP address instead of a computer name, the IP address is shown. Figure 1 shows a system with DNI Boards; your system may differ.

Figure 1. DCM Main Window

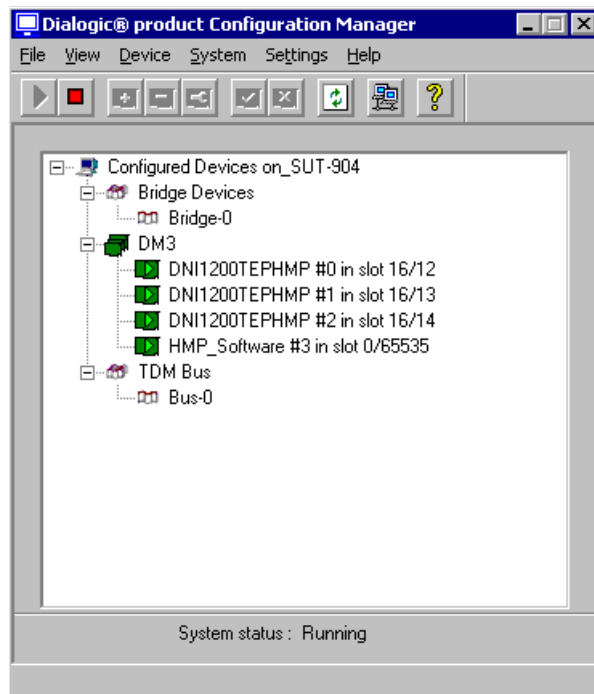

The first level of the tree structure shows the board families or categories of boards currently installed in your system, and the TDM bus, which refers to the resource bus used to carry information between HMP devices. The first level also shows the bridge device, which enables communication and media streaming between DNI Boards and the Dialogic® HMP Software. The next level displays the model names of the boards in your system. If the board model names are not displayed, click the family name node(s) to expand the tree structure.

The status window, located at the bottom of the main window, is used to display descriptive text when administrative events are received. For example, it will display "System started" when the system is started and "Device detected" when a device has been detected. The DCM also supports rollover help. When the mouse is on a particular tool bar icon, a description of the icon is displayed in the status window.

Within the DCM, each board has a set of property sheets that display the board's configuration parameters. Each property sheet displays a different set of parameters based on the functionality they affect. To access a board's property sheets, double-click on the board model name in the system window. The Misc property sheet is displayed by default. Refer to Figure 2.

Figure 2. Misc Property Sheet

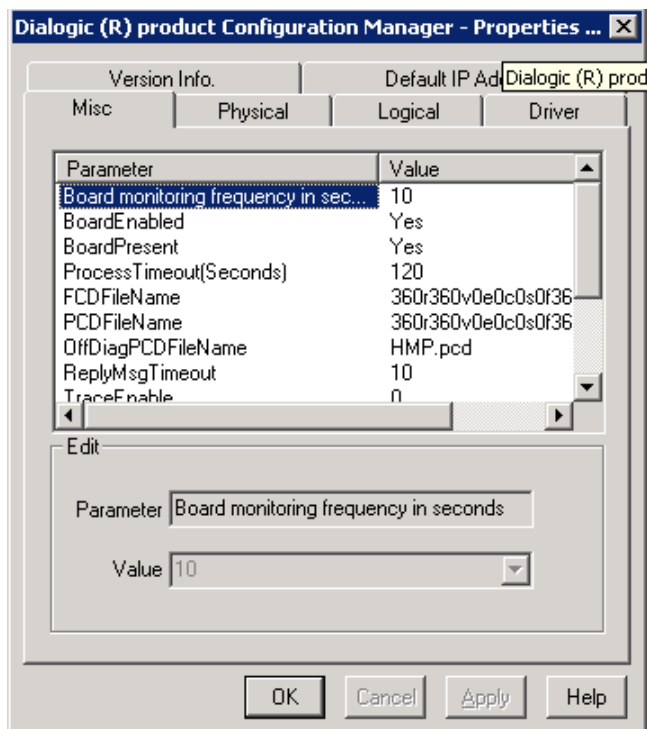

The property sheet and parameters are displayed in the property sheet window. Select a different property sheet by clicking on the appropriate property sheet tab at the top of the window. To return to the DCM main window, click the OK or Cancel button.

Parameter values are modified by selecting the parameter in the property sheet window and selecting (or entering) a new value in the Value window. Select a parameter by clicking on it. For instructions on modifying parameters, refer to [Chapter 4, “Configuration Procedures”](#).

For additional information about the DCM, including pull-down menus, shortcut icons, and parameter reference information, refer to the DCM Online Help supplied with DCM. The DCM Online Help can be accessed from the Help pull-down menu located on the DCM main window or by pressing the F1 key. To access information about a specific parameter within DCM, highlight the parameter and press the F1 key. Parameter reference information is also provided in [Chapter 6, “Dialogic® Configuration Manager \(DCM\) Parameter Reference”](#).

3.1.1 TDM Bus Parameters

This section only applies to systems with DNI Boards.

Dialogic® Configuration Manager (DCM) Details

TDM Bus parameters are located on the TDM Bus Configuration property sheet. To access this property sheet, expand the TDM Bus device on the DCM main window and double-click on the Bus-0 device. The TDM Bus Configuration property sheet is displayed. Refer to Figure 3.

Note: If you access the TDM Bus Configuration property sheet when configuring a board device (by double-clicking on the board model from the DCM main window), only a subset of parameters are viewable and they are read only.

For instructions on modifying TDM bus parameters, see [Section 4.4.2, “Setting the TDM Bus Clock Source”](#), on page 31.

Figure 3. TDM Bus Configuration Property Sheet

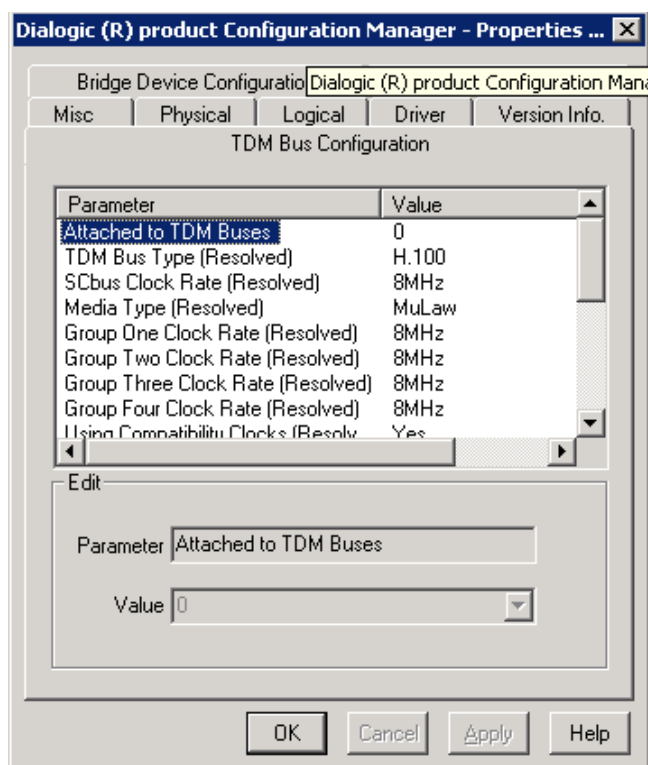

The TDM Bus Configuration parameters come in pairs, one for the User Defined value and one for the Resolved value. The User Defined value is the one that you set to change the value. The Resolved equivalent is the configuration parameter value that has been resolved by the system software. The resolved parameter value may not match the one you set through the User Defined parameter. User Defined and the Resolved equivalent parameters can be set in two ways.

Set the parameter to a value of *Default*

In this case, the value of the User Defined parameter is set to a value of *Default* and the system software determines the value of the parameter. The actual value is then indicated in the parameter's Resolved equivalent.

For example, if the **NETREF One FRU (User Defined)** parameter is set to an H.100/H.110 enabled device, and the **Derive Primary Clock From (User Defined)** parameter is set to a

value of Default, then the **Derive Primary Clock From (Resolved)** parameter will be set to NETREF_1.

Set the parameter to a specific value

In this case, the value of the User Defined parameter is set to a specific value. The system software will attempt to configure the system with the parameter when you click the Apply button on the DCM property sheet. If the value can be applied, the Resolved equivalent will be set to the same value as the User Defined parameter. If the system cannot be configured with the User Defined value, the system will select another value and display it in the parameter's resolved equivalent.

For example, if the **Derive Primary Clock From (User Defined)** parameter is set to a value of InternalOscillator, then the **Derive Primary Clock From (Resolved)** parameter will be set to a value of InternalOscillator.

Note: If the system software cannot configure the system with the User Defined value, only the Resolved equivalent will indicate the parameter's true value; the User Defined parameter will remain set to the inapplicable value. Therefore, you must always double-check the Resolved equivalent to be sure of the parameter's true value.

3.1.2 Bridge Device Parameters

This section only applies to systems with DNI Boards.

Bridge device parameters are located on the Bridge Device Configuration property sheet. To access this property sheet, expand Bridge Devices on the DCM main window and double-click on the Bridge-0 device. The Bridge Device Configuration property sheet is displayed. Refer to Figure 4.

For instructions on configuring bridge device parameters, see [Section 4.4.4, “Modifying Bridge Device Parameters”](#), on page 33. For parameter reference information, see [Section 6.2, “Bridge Device Configuration Property Sheet”](#), on page 55.

Figure 4. Bridge Device Configuration Property Sheet

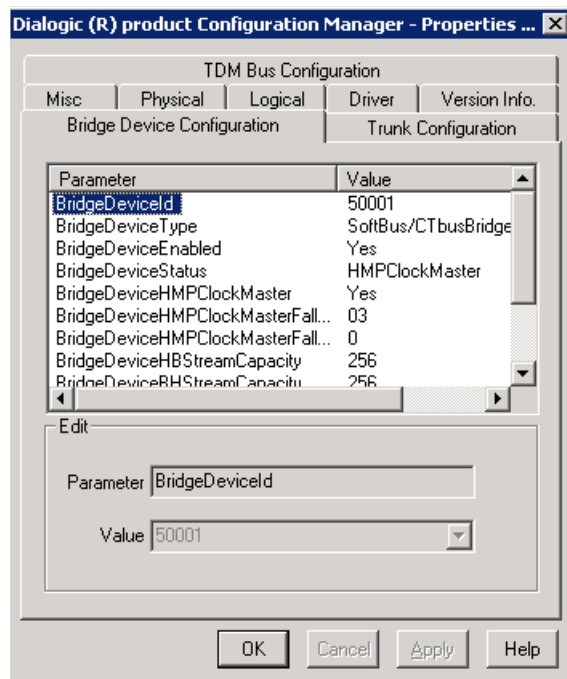

3.1.3 Bridge Controller Parameters

This section only applies to systems with DNI Boards.

Bridge controller parameters are located on the Bridge Controller property sheet. To access this property sheet, expand Bridge Devices on the DCM main window and double-click on the Bridge-0 device. The Bridge Controller property sheet is displayed. Refer to Figure 5.

For instructions on configuring bridge controller parameters, see [Section 4.4.5, "Modifying Bridge Controller Parameters"](#), on page 34. For parameter reference information, see [Section 6.1, "Bridge Controller Property Sheet"](#), on page 54.

Figure 5. Bridge Controller Property Sheet

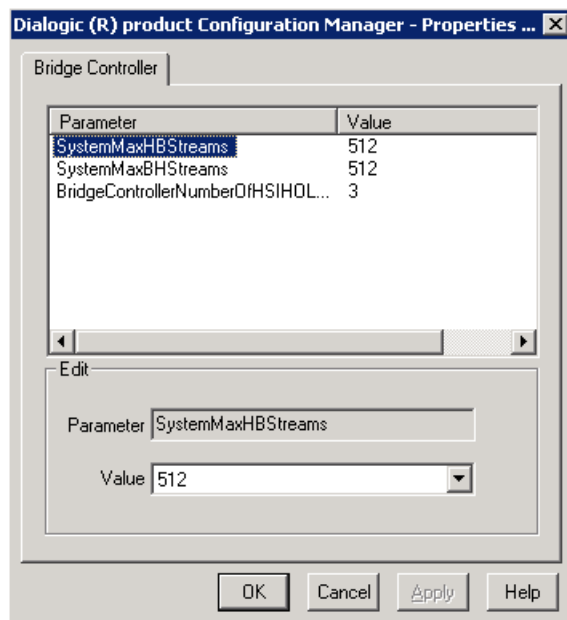

3.2 Configuration File Sets

The DCM Misc property sheet shows the **PCDFileName** and **FCDFilename** parameters. The FCD and PCD files make up the configuration file set that is downloaded to the HMP Software and to the board.

The set of files associated with a specific configuration all have the same name; only the extensions (*.pcd*, *.fcd* and *.config*) differ. A set of files is used for a specific board type. The board type can include a single board or a group of similar boards. Depending on the board type and the protocol that the board will use, a specific FCD and PCD file are downloaded to that board as identified in the DCM. If the FCD file needs to be modified, the CONFIG file in that same set is used.

The files associated with configuration file sets include:

CONFIG File

The CONFIG file (*.config*), located in the *data* directory under INTEL_DIALOGIC_DIR (the environment variable for the directory in which the software is installed), contains the modifiable parameter settings used to configure board components. For additional information about CONFIG files, see [Chapter 7, “CONFIG File Details”](#).

Feature Configuration Description (FCD) File

An FCD file (*.fcd*), located in the *data* directory under INTEL_DIALOGIC_DIR, must be downloaded to each board in the system. The purpose of the FCD file is to adjust the settings of the components that make up each product. For example, the FCD file may contain

Dialogic® Configuration Manager (DCM) Details

instructions to set certain country codes, or may send messages that configure the Telephony Service Provider (TSP) component to operate with a particular network protocol.

The FCD file defines a simple message form that the downloader parses and sends to a specific component. These parameters are sent to a component within a message and can be thought of as configurable *features* of a component. The FCD file is created automatically from the associated CONFIG file during the board initialization process. For information about changing FCD file parameters, see [Section 4.6, “Modifying the FCD File Parameters”](#), on page 36.

Note: The FCD file should not be edited directly. If parameters require modification, the changes are made by editing the associated CONFIG file. Also, an FCD file should not be copied from another directory to the *data* directory.

Product Configuration Description (PCD) File

A PCD file (*.pcd*), located in the *data* directory under INTEL_DIALOGIC_DIR, must be downloaded to each board in the system. The purpose of the PCD file is to determine the software components your system will use. It defines the product by mapping download object files to specific processors, configuring the kernel for each processor and setting the number of component instances to run on each processor.

Note: The PCD file should not be modified by the user.

In a system with one or more DNI Boards, after you select the protocols on the Trunk Configuration property sheet, new FCD and PCD files are automatically generated to reflect the protocols that were selected. FCD and PCD file names that begin with “g” are files that have been generated.

For example, *gnetworkonly_hmposbe_1_net5_7_qsige1.pcd* is a generated PCD file for a DNI/2410TEPEHMP board using NET5 on one trunk and QSIG E1 on the other trunks.

As another example, *ghmp1_hmpdsb_2_qsige1.pcd* is a generated PCD file for a DNI/601TEPHMP board using QSIG E1 on both trunks.

3.3 Media Loads

This section only applies to systems with DNI Boards.

Media loads are pre-defined sets of features. A media load consists of a configuration file set (PCD, FCD, and CONFIG files) and an associated firmware load that are downloaded to each board. The media load parameter is located on the Trunk Configuration property sheet in the DCM.

- [Features Supported](#)

3.3.1 Features Supported

This section describes the features supported by the media loads for DNI Boards.

The media loads and features supported are:

NETWORKONLY

This media load supports network interface functionality only. Media processing functionality such as tone detection and tone generation, call progress analysis, and echo cancellation are provided by the Dialogic® HMP Software.

The following Dialogic® HMP Interface Boards (PCI Express) use this media load: DNI/310TEPEHMP, DNI/610TEPEHMP, DNI/1210TEPEHMP, DNI/2410TEPEHMP.

The following Dialogic® HMP Interface Boards (Universal PCI) use this media load: DNI/300TEPHMP and DNI/1200TEPHMP.

HMPL1

Dialogic® DNI/601TEPHMP boards support a media load called HMPL1. This media load supports network interface functionality as well as some media processing functionality required for call control signaling, namely tone detection, tone generation, and call progress analysis. In addition, echo cancellation is performed on media received from the T1/E1 interface prior to that media being sent to the CT Bus and/or the Dialogic® HMP Software. Therefore, echo cancellation capabilities of other resources, such as IP media and conferencing, are not required for connections between these resources and T1/E1 interfaces on the DNI/601TEPHMP boards. Other media processing resources are provided by the Dialogic® HMP Software.

3.4 CT Bus (TDM) Clocking

This section only applies to systems with DNI Boards.

The system provides clocking and clock fallback to maintain timing in the event that the current clock source fails. The following provides reference information about the types of clock fallback:

- [Primary Clock Fallback](#)

3.4.1 Primary Clock Fallback

For the following discussion, refer to [Figure 6, “Clock Fallback”](#), on page 24 for an illustration of the CT Bus clocking concepts.

The Primary Clock Master is a device (board) that provides timing to all other devices attached to the bus. The Primary Clock Master drives bit and framing clocks for all of the other boards (slaves) in the system via CT Bus Line A or Line B. This bus clocking is synchronized to either the board's internal oscillator or, preferably, to the NetRef1 line which provides a timing reference (8 kHz) derived from a T1 or E1 interface signal.

The timing reference is provided by the Reference Master board. A T1 or E1 trunk on the Reference Master board is the source for the T1 or E1 interface signal from which the 8 kHz timing reference is derived. The timing reference is sent from the Reference Master board to the NetRef1 line.

In addition, a Secondary Clock Master can be defined as a backup for the same purpose. This board, like the Primary Clock Master, is capable of driving the bit and framing clocks for all of the

Dialogic® Configuration Manager (DCM) Details

other boards in the system. The Secondary Clock Master uses whichever CT Bus line (A or B) is not defined for the Primary Master Clock. If the system senses a failure of the Primary Clock Master, the system will cause the clock source to fall back to the Secondary Clock Master. The Secondary Clock Master, like the primary, also provides clocking that is synchronized to either the board's internal oscillator or, preferably, to the NetRef1 line.

Figure 6. Clock Fallback

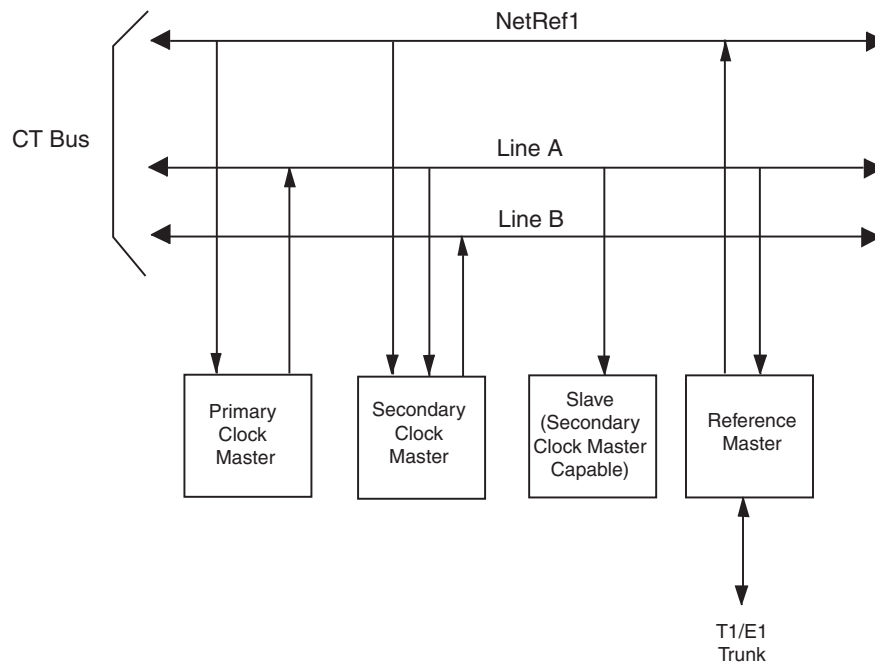

In the case where the Primary Clock Master has failed, and the clock source falls back to the Secondary Clock Master, the system selects a new Secondary Clock Master, assuming that a board in the system meets the criteria for a clock master.

If the Primary Clock Master fails and no Secondary Clock Master has been defined, the system will automatically choose another board to be Primary Clock Master, if another board in the system is clock master capable.

Both the Primary and Secondary Clock Masters are defined by the user. For instructions on specifying the clock source, see [Section 4.4.2, “Setting the TDM Bus Clock Source”](#), on page 31. For parameter reference information, see [Section 6.7, “TDM Bus Configuration Property Sheet”](#), on page 70.

3.5 Dialogic® HMP Software Clocking and Fallback

Dialogic® Dialogic® HMP Interface Boards (DNI Boards) include a bridge device that can stream data between the boards connected to the CT Bus and Dialogic® HMP Software, and additionally is capable of providing clocking to Dialogic® HMP Software. The clocking provided to Dialogic®

Dialogic® Configuration Manager (DCM) Details

HMP Software from a DNI Board is derived from CT Bus clocking. In a Dialogic® HMP Software system that contains DNI Boards, one board is selected as the Primary Clock Master for Dialogic® HMP Software. Additional boards serve as backup clocking sources for Dialogic® HMP Software, via a fallback list, should the Dialogic® HMP Software Primary Clock Master fail.

In a Dialogic® HMP Software system with no DNI Boards, Dialogic® HMP Software clocking is derived from an alternate system clock source. This alternate system clock source also serves as the last Dialogic® HMP Software clock source on the fallback list.

The parameters for configuring clocking provided to Dialogic® HMP Software from DNI Boards are located on the Bridge Device Configuration Property sheet in the DCM. For instructions on configuring these parameters, see [Section 4.4.4, “Modifying Bridge Device Parameters”](#), on page 33. For parameter reference information, see [Section 6.2, “Bridge Device Configuration Property Sheet”](#), on page 55.

The following topics provide procedures for each major step in the configuration process (some steps may not apply to your system configuration):

- Assumptions and Prerequisites 26
- Order of Procedures 27
- Starting the Dialogic® Configuration Manager (DCM) 28
- Configuring Dialogic® HMP Interface Boards 29
- Modifying Other DCM Property Sheet Parameters 35
- Modifying the FCD File Parameters 36
- Initializing the System 38
- Reconfiguring the System 38
- Preserving Data in User Configuration Files 39

4.1 Assumptions and Prerequisites

The following assumptions and prerequisites exist regarding the configuration procedures:

- All required software, including prerequisites, have been installed according to the procedures in the software installation guide supplied with your release.
- The release was installed in the default directory under INTEL_DIALOGIC_DIR, the environment variable for the directory in which the software is installed. Command instructions, directories paths and environment variable are shown relative to the default installation directory.
- If used, the Dialogic® HMP Interface Boards (DNI Boards) have been installed according to the procedures in the hardware installation guide supplied with the board.
- You have administrative privileges on the local computer and on any remote computer you connect to in order to use the Dialogic® Configuration Manager (DCM). Contact your network administrator to set up administrative privileges as required.
- If applicable, the Global Call protocols have been installed. The Global Call protocols are provided as part of the release. For information about country dependent parameters associated with a protocol, see the *Dialogic® Global Call Country Dependent Parameters (CDP) for PDK Protocols Configuration Guide*.

4.2 Order of Procedures

The following is a suggested order for performing configuration procedures. Procedures that are required when configuring any system are noted as such. Additional procedures may be required depending on your system.

1. [Starting the Dialogic® Configuration Manager \(DCM\) \(required\)](#)
2. For DNI Boards, these additional procedures may be applicable:
 - 2a. [Selecting a Configuration File Set](#)
 - 2b. [Setting the TDM Bus Clock Source](#)
 - 2c. [Setting the Bus Companding Method](#)
 - 2d. [Modifying Bridge Device Parameters](#)
 - 2e. [Modifying Bridge Controller Parameters](#)
 - 2f. [Configuring the Global Call CDP File](#)
3. [Modifying Other DCM Property Sheet Parameters](#)
4. [Modifying the FCD File Parameters](#)
5. [Initializing the System \(required\)](#)
6. [Reconfiguring the System](#)
7. [Preserving Data in User Configuration Files](#)

4.3 Starting the Dialogic® Configuration Manager (DCM)

Note: Online Help is available for all parameters accessible through the DCM; to access the help, choose **Help > Contents** in the DCM main window.

To start the DCM, perform the following steps:

1. From the Windows® **Start** menu, choose **Programs > HMP > Configuration Manager-DCM** to access the DCM. The Computer Name dialog box will appear (Figure 7).

Note: The Computer Name dialog box displays automatically the first time you run the DCM with the local computer name as the default. If the Computer Name dialog box is not already displayed, you can get it by choosing **File > Connect** or by clicking the Connect icon on the DCM main window.

Figure 7. Computer Name Dialog Box

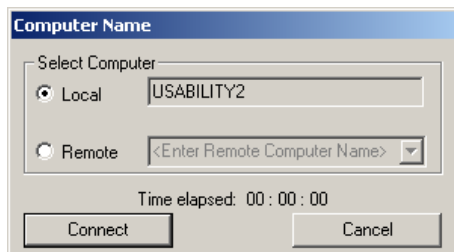

Note: The Dialogic® Host Media Processing (HMP) Software uses DCOM objects to run Dialogic® HMP Software on remote computers. Remote DCM software internally sets up the DCOM security level programmatically. Do *not* use the Windows® DCOM configuration utility *dcomcnfg.exe* to change the security settings. If you do, the Dialogic® HMP Software may not work properly. For example, on a Windows® machine, if you change the setting to Anonymous, the Dialogic® HMP Software does not work properly.

Note: To use remote DCM across firewalls, enable the port used by the DCOM Server, *DCMObj.exe*, in the firewall configuration. *DCMObj.exe* is located in the *bin* directory. To determine the port used by *DCMObj.exe*, first use the Windows® Task Manager to find out the PID of *DCMObj.exe*. Once you know the PID, you can use a port usage utility to find out the port used by *DCMObj.exe*. Windows® XP users can run `netstat -o` to find the port.

2. Connect to either the local computer or a remote computer as follows:
 - To connect to the local computer, click **Connect**.
 - To connect to a remote computer, select the **Remote** radio button, enter the remote computer name, and click **Connect**. For TCP/IP networks, you can enter the IP address instead of the remote computer name.

After you connect to a computer, a window will appear that indicates that boards are being detected followed by the DCM main window. The DCM main window contains a tree structure of the boards installed in your system. Refer to [Figure 1, “DCM Main Window”](#), on page 16.

In addition to the DCM main window, a system tray icon is also created. For details about the DCM system tray icon, refer to the DCM Online Help.

Continue with any additional configuration procedures that are applicable to your system. When you are satisfied with all configuration information, proceed with [Section 4.7, “Initializing the System”](#), on page 38.

4.4 Configuring Dialogic® HMP Interface Boards

For systems that contain DNI Boards, additional procedures may be applicable:

- [Selecting a Configuration File Set](#)
- [Setting the TDM Bus Clock Source](#)
- [Setting the Bus Companding Method](#)
- [Modifying Bridge Device Parameters](#)
- [Modifying Bridge Controller Parameters](#)
- [Configuring the Global Call CDP File](#)

4.4.1 Selecting a Configuration File Set

The first time you configure a board, you can select configuration files other than the default files assigned by the system, in one of these ways:

- by modifying parameters on the Misc property sheet, or
- by using the Assign Firmware File dialog box, or
- by modifying parameters on the Trunk Configuration property sheet. For details about configuration file sets, see [Section 3.2, “Configuration File Sets”](#), on page 21.

To select different configuration files using the Misc property sheet, perform the following:

1. Double-click the board model name on the DCM main window to display the board’s property sheets. Refer to [Figure 2, “Misc Property Sheet”](#), on page 17.
Note: You must use this procedure if you want to assign a different PCD/FCD file set to the board.
2. Click the Misc property sheet tab to view all of the Misc property sheet parameters associated with the board.
3. Select the **FCDFileName** parameter by clicking on it; the selected parameter and its current value are displayed on the bottom of the property sheet.
4. In the Value window of the property sheet, type the name of the FCD file to be assigned to this board.
5. Select the **PCDFileName** parameter by clicking on it; the selected parameter and its current value are displayed on the bottom of the property sheet.

Configuration Procedures

6. In the Value window of the property sheet, type the name of the PCD file to be assigned to this board.
7. Click the OK button to save all your changes and return to the DCM main window.

To select different configuration files using the Assign Firmware File dialog box, perform the following:

1. From the DCM System pull-down menu, select the Auto Detect Devices option. The Assign Firmware File dialog box will appear. Refer to [Figure 8, “Assign Firmware File Dialog Box”](#), on page 31.
2. In the Available Firmware window, select the PCD file that corresponds to the configuration file set you want to assign to this board.
3. Click the OK button. The selected PCD file name will be assigned to the **PCDFileName** parameter located on the board’s Misc property sheet. The corresponding FCD file will be assigned to the **FCDFileName** parameter also located on the board’s Misc property sheet.

To select different configuration files using the Trunk Configuration property sheet, perform the following:

1. From the DCM Main Window (Figure 1), highlight the board you wish to configure and choose Configure Device from the Device drop down menu. The property sheets for this board will appear.
2. Select the Trunk Configuration property sheet, and assign a protocol type to each trunk on the board. Then click OK to save the configuration. The configuration files will then be generated and set. See [Section 6.8, “Trunk Configuration Property Sheet”](#), on page 79.

Figure 8. Assign Firmware File Dialog Box

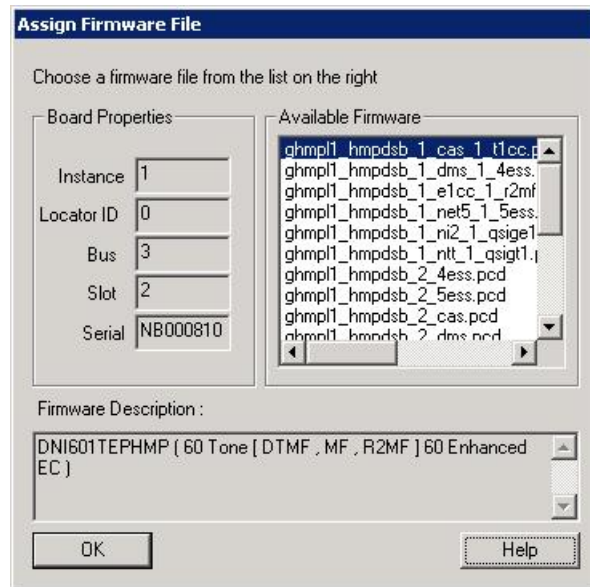

Continue with any additional configuration procedures that are applicable to your system. When you are satisfied with all configuration information, proceed with [Section 4.7, “Initializing the System”](#), on page 38.

4.4.2 Setting the TDM Bus Clock Source

The *default clock source* is the internal oscillator of the Primary Master board. You should derive clocking from a digital network trunk if available, not from a board’s internal oscillator. The internal oscillator should be used as the clock source only for internal testing purposes.

1. To access the clocking settings in the DCM, double-click **Bus-0** under TDM Bus in the DCM tree structure of configured devices. Refer to [Figure 1, “DCM Main Window”](#), on page 16. The TDM Bus Configuration property sheet for Bus-0 is displayed. Refer to [Figure 3, “TDM Bus Configuration Property Sheet”](#), on page 18.
2. Designate a board as the primary master by performing the following:
 - 2a. Select the **Primary Master FRU (User Defined)** parameter.
 - 2b. In the Value list box select the name of the board that will provide the clocking to the bus.
 - 2c. Click **Apply**.
3. If the Primary Master board is deriving system clocking from a digital network trunk connected to a Network Reference (NETREF) board (also known as the Reference Master board), perform the following. Otherwise, if you are using the Primary Master board’s internal oscillator as the clocking source, skip to Step 4.
 - 3a. Select the **NETREF One FRU (User Defined)** parameter.

Configuration Procedures

- 3b. In the Value box, type the name of the board that contains the network interface which will provide a network reference clock to the system. The board name you enter should be the same name as displayed in the DCM main window.
- 3c. Click **Apply**.
- 3d. Specify the source of the network reference clock (specifically, the trunk on the board containing the digital network interface providing the clock) via the **Derive NETREF One From (User Defined)** parameter.
- 3e. Click **Apply**.
4. Configure the Primary Master board to use the correct clock reference by setting the **Derive Primary Clock From (User Defined)** parameter to either NETREF_1 or Internal Oscillator.
5. Click **OK**.
6. Designate a board as the secondary clock master by performing the following:
 - 6a. Select the **Secondary Master FRU (User Defined)** parameter.
 - 6b. In the Value list box, select the name of the board that will provide the clocking to the bus if the primary master fails.
 - 6c. Click **Apply**.
 - 6d. Configure the Secondary Master board to use the correct clock reference by setting the **Derive Secondary Clock From (User Defined)** parameter to either NETREF_1 or Internal Oscillator.
 - 6e. Click **OK**.

Continue with any additional configuration procedures that are applicable to your system. When you are satisfied with all configuration information, proceed with [Section 4.7, “Initializing the System”](#), on page 38.

4.4.3 Setting the Bus Companding Method

The bus companding method is defined using the **Media Type (User Defined)** parameter. This parameter is associated with the TDM Bus Configuration for Bus-0 in DCM. Initially, the **Media Type (User Defined)** value is set to **Default**. This causes the system to default to the value determined by the **Media Type (Resolved)** parameter. In this case, the bus companding method as indicated by **Media Type (Resolved)** parameter is:

- mu-law: for DNI Boards

For DNI Boards whose trunks can individually connect to either T1 or E1 interfaces, the companding method will automatically be converted on the board, if necessary, on a trunk-by-trunk basis to agree with that of the TDM Bus companding method. For example, if the TDM Bus is set to mu-law, the board will perform A-law to mu-law conversion between the board and TDM Bus for the E1 trunks.

Follow these instructions to set the bus companding method:

1. Double-click **Bus-0** under TDM Bus in the DCM main window to display the TDM Bus Configuration property sheet for Bus-0.
2. Select the **Media Type (User Defined)** parameter by clicking on it.
3. Select **A-Law** or **mu-Law**, as appropriate, from the pull-down menu.
4. Click **OK** to set the parameter and return to the DCM main window.

Continue with any additional configuration procedures that are applicable to your system. When you are satisfied with all configuration information, proceed with [Section 4.7, “Initializing the System”](#), on page 38.

4.4.4 Modifying Bridge Device Parameters

DNI Boards have a bridge device that enables communication and media streaming between Dialogic® HMP Software and the boards on the CT Bus. The bridge device parameters are used by these boards. Some parameters are read only, while others can be configured. Configurable parameters come with default values. For detailed parameter reference information, see [Section 6.2, “Bridge Device Configuration Property Sheet”](#), on page 55.

To change default values of configurable bridge device parameters for a board, follow these instructions:

1. Double-click the board model name in the DCM main window to display the board’s property sheets. The Misc property sheet is displayed; see Figure 2.
2. Click on the Bridge Device Configuration property sheet tab to view all of the bridge device parameters associated with the board.
3. If desired, designate this specific bridge device as a primary master by performing the following:
 - 3a. Select the **BridgeDeviceHMPClockMasterFallbackNbrUserDefined** parameter.
 - 3b. In the Value list box, select a new value that is lower than the default value. For example, select 1 or 2. The bridge device with the lowest number is chosen by the bridge controller as the Dialogic® HMP Software clock master. Bridge devices with higher numbers serve as fallback clock masters as needed. If multiple boards share the same value, the bridge controller determines the bridge device that will be the clock master. (The default value for all digital network interface boards is 3.)
4. If desired, adjust the number of Dialogic® HMP Software to Board streams for this bridge device.
 - 4a. Select the **BridgeDeviceMaxHBStreamSetting** parameter.
 - 4b. In the Value list box, select a new value. (The default value is 256.)

Configuration Procedures

Note: You can also adjust the number of Dialogic® HMP Software to Board streams at a system level using the **SystemMaxHBStreams** parameter on the Bridge Controller property sheet. See [Section 4.4.5, “Modifying Bridge Controller Parameters”](#), on page 34.

5. If desired, adjust the number of Board to Dialogic® HMP Software streams for this bridge device.

5a. Select the **BridgeDeviceMaxBHStreamSetting** parameter.

5b. In the Value list box, select a new value. (The default value is 256.)

Note: You can also adjust the number of Board to Dialogic® HMP Software streams at a system level using the **SystemMaxBHStreams** parameter on the Bridge Controller property sheet. See [Section 4.4.5, “Modifying Bridge Controller Parameters”](#), on page 34.

Continue with any additional configuration procedures that are applicable to your system. When you are satisfied with all configuration information, proceed with [Section 4.7, “Initializing the System”](#), on page 38.

4.4.5 Modifying Bridge Controller Parameters

DNI Boards have a bridge device that enables communication and media streaming between Dialogic® HMP Software and the boards on the CT Bus. The media stream connections are managed by the bridge controller. All parameters on the Bridge Controller property sheet can be configured; the parameters come with default values. For detailed parameter reference information, see [Section 6.1, “Bridge Controller Property Sheet”](#), on page 54.

To change a system’s bridge controller parameter values, follow these instructions:

1. Double-click **Bridge-0** device under Bridge Devices in the DCM main window to display the Bridge Controller property sheet.

2. If desired, adjust the number of Dialogic® HMP Software to Boards streams in the system to be allocated in the Dialogic® HMP Software to Boards direction.

2a. Select the **SystemMaxHBStreams** parameter.

2b. In the Value list box, select a new value. (The default value is 512.)

Note: You can also adjust the number of Dialogic® HMP Software to Board streams at a board level using the **BridgeDeviceMaxHBStreamSetting** parameter on the Bridge Device Configuration property sheet. See [Section 4.4.4, “Modifying Bridge Device Parameters”](#), on page 33.

3. If desired, adjust the number of Boards to Dialogic® HMP Software streams in the system to be allocated in the Boards to Dialogic® HMP Software direction.

3a. Select the **SystemMaxBHStreams** parameter.

3b. In the Value list box, select a new value. (The default value is 512.)

Note: You can also adjust the number of Board to Dialogic® HMP Software streams at a board level using the **BridgeDeviceMaxBHStreamSetting** parameter on the Bridge Device Configuration property sheet. See [Section 4.4.4, “Modifying Bridge Device Parameters”](#), on page 33.

4. If desired, adjust the number of Host Streaming Interface (HSI) hold buffers.
 - 4a. Select the **BridgeControllerNumberOfHSIHOLDBuffers** parameter.
 - 4b. In the Value list box, select a new value. (The default value is 3.)

Continue with any additional configuration procedures that are applicable to your system. When you are satisfied with all configuration information, proceed with [Section 4.7, “Initializing the System”](#), on page 38.

4.4.6 Configuring the Global Call CDP File

If you are using the Global Call protocols, see the *Dialogic® Global Call Country Dependent Parameters (CDP) for PDK Protocols Configuration Guide* for the following configuration procedures:

- Configuring the country dependent parameters (CDP) file
- Downloading the protocol and CDP file

4.5 Modifying Other DCM Property Sheet Parameters

Within the DCM, each board has a set of property sheets that display the board’s configuration parameters, grouped together on tabs according to the type of board functionality that they affect. To change a board’s configuration parameters, follow this procedure:

1. Double-click the board model name in the DCM main window to display the board’s property sheets. The Misc Property Sheet is displayed; see [Figure 2, “Misc Property Sheet”](#), on page 17.
2. Click a property sheet tab to view all of the board parameters associated with a particular property sheet. For example, to view the parameters associated with the Physical property sheet, click the **Physical** tab. Refer to Figure 9.

Refer to the DCM Online Help for a description of property sheets and parameters. The DCM Online Help can be accessed from the Help pull-down menu located on the DCM main window or by pressing the F1 key. To access information about a specific parameter, highlight the parameter in the DCM and press the F1 key.

3. Select a parameter by clicking it; the selected parameter and its current value are displayed on the bottom of the property sheet.
4. In the Value box of the property sheet, type the parameter value or select a value from the drop-down list.
5. Click **Apply** to save the change.

Configuration Procedures

6. Repeat this procedure for all parameters that need to be modified.
7. Click **OK** to save all your changes and return to the DCM main window.

Continue with any additional configuration procedures that are applicable to your system. When you are satisfied with all configuration information, proceed with [Section 4.7, “Initializing the System”](#), on page 38.

Figure 9. Physical Property Sheet

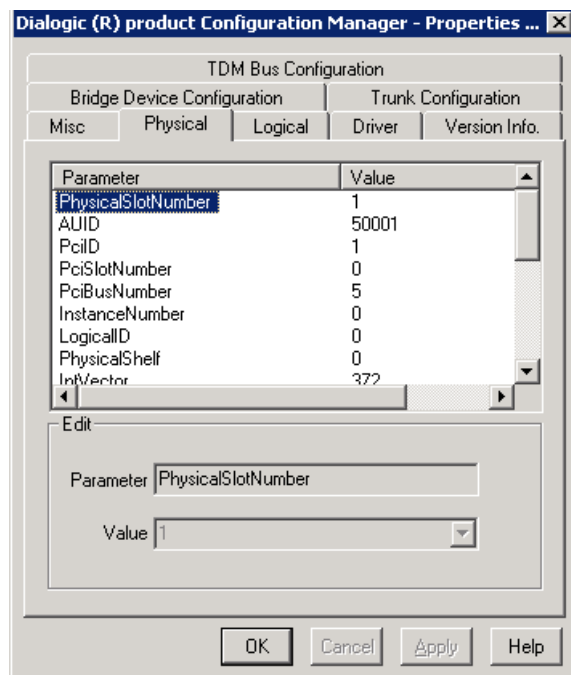

4.6 Modifying the FCD File Parameters

If the default settings in the FCD files are not appropriate for your configuration, you can modify the FCD file parameters using the CONFIG file and the *fedgen* utility. Modifications can be made at any time prior to starting the system.

For each FCD file to be modified, the procedure includes:

1. [Editing the CONFIG File](#)
2. [Generating the FCD File](#)

4.6.1 Editing the CONFIG File

The first step in generating a modified FCD file is to edit the corresponding CONFIG file. Once the CONFIG file parameters are modified, the *fcdgen* utility is used to convert the CONFIG file to an FCD file.

Note: If you want to preserve the default parameter values contained in the CONFIG file, make a backup copy of the file prior to editing it.

To edit the CONFIG file:

1. From the command prompt, go to the *data* directory and locate the CONFIG file.
2. Using a text editor (for example, WordPad), open the CONFIG file that corresponds to the FCD file you want to modify. By default, the CONFIG file will have the same file name as the FCD file, but with a *.config* extension.
3. Edit the CONFIG file as necessary.

For a detailed description of the CONFIG file sections and formatting conventions, see [Chapter 7, “CONFIG File Details”](#). For details about CONFIG file parameters, see [Chapter 9, “CONFIG File Parameter Reference for Dialogic® HMP Interface Boards”](#).

4. Save and close the CONFIG file.

Proceed with [Section 4.6.2, “Generating the FCD File”](#), on page 37.

4.6.2 Generating the FCD File

In order to generate an FCD file, the corresponding CONFIG file must be converted to an FCD file. *fcdgen* converts the CONFIG file into a format that can be read directly by the downloader.

1. From the command prompt, go to the *data* directory.
2. Execute *fcdgen* as follows:

```
..\bin\fcdgen -f <input file>.config -o <output file>.fcd
```

For example:

```
..\bin\fcdgen -f ghmp1_hmpdsb_2_qsig1.config
```

The resulting FCD file is created in the *data* directory. If the *-o* option is omitted from the command, the default output FCD file will have the same filename as the user-modified input configuration file, but with a *.fcd* extension.

Continue with any additional configuration procedures that are applicable to your system. When you are satisfied with all configuration information, proceed with [Section 4.7, “Initializing the System”](#), on page 38.

4.7 Initializing the System

Note: The new configuration settings will not take effect until the system is initialized. Before system initialization, make sure you perform all of the necessary configuration procedures.

To initialize the system for the first time, proceed as follows:

1. From the DCM main window, select the root of the tree structure (Configured Devices on...).
2. Choose **Device > Enable Device(s)** or click the Enable Device(s) icon on the DCM toolbar.
3. Choose **System > Start System** or click the Start all Enabled Devices icon on the DCM toolbar.
4. Verify the system has started (indicated by a status of “Started” in the System status line at the bottom of the DCM main window).
5. After starting the system for the first time, you may want to use some of the tools, such as demo programs, provided by the system software to verify that your system is operating properly.
6. If you have problems, see the Troubleshooting section of the Administration Guide. Problems on initial startup are typically caused by errors in your configuration settings.

Once the system is initialized for the first time, the system can be reconfigured and re-initialized as described in [Section 4.8, “Reconfiguring the System”](#), on page 38.

4.8 Reconfiguring the System

Once the Dialogic® HMP Software is initialized for the first time, if you need to modify and re-download the parameters, following these instructions to reconfigure the system:

1. Before you stop the system, stop the application ensuring all channels have been closed.
2. Launch the configuration manager utility by choosing **Programs > Dialogic® HMP Software > Configuration Manager-DCM** from the Windows Start menu. The DCM main window is displayed. Refer to [Figure 1, “DCM Main Window”](#), on page 16.
3. Stop either the complete system or a single board, as appropriate:
 - To stop the system, choose **System > Stop System** or click the Stop System icon in the DCM main window before changing parameter values. The system is stopped once “Stopped” is displayed on the System status line at the bottom of the DCM main window.
 - To stop a single board, choose **Device > Stop Device**.
4. Double-click the board model name to display the configuration data property sheets pertaining to the board. Refer to [Figure 1, “DCM Main Window”](#), on page 16.

5. If you wish to restore the board's DCM parameter settings to their default values, choose **Device > Restore Defaults** in the DCM main window. This resets *all* of the board's modified parameters to their default values in the DCM.
6. If you wish to reset the FCD file parameters to their default values, perform the following:
 - Note:** This step only applies if a backup copy of the CONFIG file was made prior to modifying the parameters.
 - 6a. Rename the backup CONFIG file to its original file name.
 - 6b. Generate a new FCD file as described in [Section 4.6, "Modifying the FCD File Parameters"](#), on page 36.
7. Modify parameters as needed for your environment, as described in this chapter.
8. When you're finished changing parameters, restart the system or a single board, as appropriate:
 - Start the whole system by choosing **System > Start System** or clicking the Start System icon in the DCM main window. The system is started once "Started" is displayed on the System status line at the bottom of the DCM main window. The firmware and new configuration settings are downloaded once the system is started.
 - To start a single board, choose **Device > Start Device**. The firmware and new configuration settings are downloaded to the board once the board is started.

For detailed procedures about reconfiguration and other administrative tasks, see the administration guide supplied with your software.

4.9 Preserving Data in User Configuration Files

Configuration settings unique to your environment can be preserved and re-applied whenever a Dialogic® HMP Software license is changed or reactivated.

Previously customized settings in the `<licensename>.config` file (the default `.config` file created during license generation) were lost every time a new Service Update was installed or a new Dialogic® HMP Software license was activated. These customized settings then had to be re-entered.

A user configuration file, `Hmp.Uconfig`, is now available. This file, which has the same format as the `<licensename>.config` file, contains only the parameters and parameter values that are customized for your environment. The contents of the `Hmp.Uconfig` file are not overwritten but are merged into the `<licensename>.config` file whenever a new Service Update is installed or a new HMP Software license is activated.

To preserve custom configuration settings in a user configuration file, follow these steps:

1. Create an `Hmp.Uconfig` file in the `data` directory under `INTEL_DIALOGIC_DIR`, the environment variable for the directory in which the HMP Software is installed. You may also want to make a copy of the `Hmp.Uconfig` file and save it in a safe location as a backup.
2. Delete the `.pcd`, `.fcd`, and `.config` files.

Configuration Procedures

3. Restart the system. The *.pcd*, *.fcd*, and *.config* files are regenerated with the new settings.

If you do not want the customized parameters in the *Hmp.Uconfig* file to be merged into the generated *<licensename>.config* file, you should either remove the *Hmp.Uconfig* file from the data directory or rename it.

Example

The following is a sample *Hmp.Uconfig* file, where the default AGC setting has been changed and a new parameter has been added:

```
[encoder]
SetParm=0x400,0    !AGC Enabled (1=Enable, 0=Disable)

[0xe]
SetParm=0xb17,4    !QFC3_ PrmResponseTimeout default 3 seconds
```

The following is a sample excerpt of a merged *<licensename>.config* file. It shows the new AGC setting in the [encoder] section followed by the default value for AGC, commented by “!^”. It also shows a new parameter in [0xe], delimited by the “!<add>”.

```
[encoder]
SetParm=0x400,0    !AGC Enabled (1=Enable, 0=Disable)
!^SetParm=0x400,1  !AGC Enabled (1=Enable, 0=Disable)

[0xe]
...
!<add>
SetParm=0xb17,4    !QFC3_ PrmResponseTimeout default 3 seconds
!</add>
```

This chapter discusses echo cancellation support and configuration in the Dialogic® Host Media Processing (HMP) Software. The following topics are covered:

- [Echo Cancellation Background Information](#) 41
- [Echo Cancellation Features](#) 43
- [Using Echo Cancellation](#) 44
- [Configuring Host-Based Echo Cancellation](#) 45
- [Host-Based Echo Cancellation Sample Scenarios](#). 49
- [Configuring On-Board Echo Cancellation](#) 52

5.1 Echo Cancellation Background Information

This section provides background information on echo cancellation:

- [Overview](#)
- [Acoustic Echo](#)
- [Electrical Echo](#)

5.1.1 Overview

The presence of echo on a media stream can negatively impact user satisfaction with voice quality. The degree to which echo is objectionable depends on both the loudness of the echo and the total round-trip delay. The impact of an echo increases as round-trip delays increase, affecting the user's perception of echo. If the delay is small (less than 20 ms), the user hears nothing or at most a reverberant sounding side-tone. Larger delays, however, lead to a subjective annoyance perceived as echo. The larger the delay, the less masking there is by the direct speech and the more annoying the echo becomes.

The presence of echo on a media stream can also negatively impact the reliability of automated media processing such as voice recognition or digit detection when voice prompts, for example, are played to a caller. In this case, a round-trip echo delay of less than 20 ms makes the returned echo unacceptable. For media processing algorithms, it is the loudness of the echo that is most problematic. Media processing algorithms typically function much better when echo is removed, or at a minimum suppressed to very low levels.

There are two basic types of echo to consider: acoustic echo and electrical echo.

Echo Cancellation

5.1.2 Acoustic Echo

Acoustic echo occurs when sound waves emitted from the receiver of an analog or digital handset (telephone) are reflected back, or coupled back, into the microphone of that handset. If the echo is not sufficiently cancelled or suppressed within the handset or elsewhere, the echo will return to the source of the sound waves, such as the remote caller, and can result in unacceptable voice quality.

Acoustic echo is typically cancelled at the handset. This is true for analog, digital, wireless, as well as IP handsets. Acoustic echo, however, can be an issue if low quality handsets are involved in a call or, in some cases, when a caller is using the hands-free mode of a handset that also does not do a proper job in canceling the acoustic echo.

The public switched telephone network (PSTN) has no special provision to compensate for acoustic echo.

5.1.3 Electrical Echo

Electrical echo typically occurs when a call traverses between a 2-wire and 4-wire physical transport. On the 4-wire transport, the transmit signal and the receive signal travel on separate wire pairs. On the 2-wire transport, the transmit signal and the receive signal share the same wire pair. The interface between the 2-wire transport and the 4-wire transport is known as the **hybrid**. Since the 2-wire transport carries both the signal being sent to the 2-wire transport from the 4-wire transport (signal A) and the signal being sent from the 2-wire transport to the 4-wire transport (signal B), the hybrid must subtract signal A from the combined signal A+B on the 2-wire transport to obtain signal B to forward on to the 4-wire transport.

Let's examine the example where a 2-wire local analog loop from a subscriber's handset is connected via the hybrid to a 4-wire transport deeper within the PSTN, Figure 10. The hybrid attempts to subtract the signal that is being transmitted from the 4-wire transport to the 2-wire local loop from the combined signals on the 2-wire local loop to obtain the desired signal being sent toward the PSTN from the handset. Ideally, the signal being subtracted would match exactly the signal being sent to the 2-wire local loop from the 4-wire transport, so that the received data on the 4-wire side of the hybrid would contain only the signal sent to the PSTN by the handset. It would not contain any reflected signal or echo.

Figure 10. Electrical Echo and the Hybrid

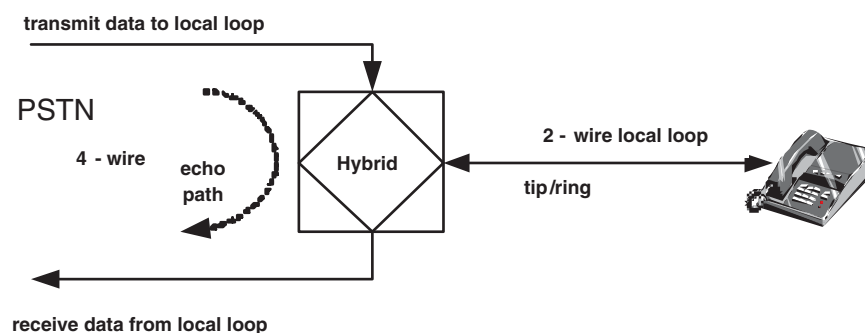

However, in the real world, the ability of the hybrid to remove the transmitted signal is imperfect. The term hybrid balance refers to the ratio (expressed in dB) of the signal being transmitted from the 4-wire side to the apparent (reflected) signal received back at the 4-wire side. If the hybrid balance is not perfect due to impedance mismatches, for instance, then a fraction of the signal being sent is reflected back to the sender. If a delay in the network occurs, the sender hears an echo, which can be objectionable.

The PSTN compensates for electrical echo created within the PSTN under certain connections by inserting echo suppressors or cancellation devices in the path of the call. This is done when a hybrid is included within the route of the call and when the round-trip echo delay exceeds a limit, typically less than 25 ms, above which the echo is deemed to be objectionable. This would be the case, for example, for some long distance calls as well as calls using a satellite link. For the majority of calls, including local calls and also many long distance calls, the round-trip delays are well below 25 ms and, therefore, echo compensation is not provided by the PSTN.

The criteria used to determine when or when not to insert echo compensation in the PSTN, however, assumes that terminal devices such as handsets and combinations of PBX's with handsets behind them add relatively small additional delays beyond the delays resulting from the PSTN connection. When echo exists on the received media stream and additional delays are introduced into the call connection beyond those budgeted by the PSTN, echo cancellation is required if these additional delays cause the total round-trip delay to exceed approximately 25 ms. If echo cancellation is not provided under these circumstances, callers may experience objectionable echo.

An example of when echo cancellation is not provided is for call connections that span PSTN and IP networks. While the round-trip delay may be small (a few milliseconds on the PSTN side) the delays introduced by the IP network portion of the connection may be in the order of 100 ms. IP networks can also introduce lost or replaced packets, as well as packet jitter, making for a non-linear environment in which it is very difficult to identify and cancel all echoes at the point where media leaves the packet network. Due to these significant delays and potential impairments, gateways which interface between the PSTN and IP network are required to remove any echo received from the PSTN side prior to transmitting audio onto the IP network. Likewise, IP phones must also remove echo before transmitting audio onto the IP network. Conferencing is another example where additional delays are added into the connection path. Therefore, conference bridges typically provide echo cancellation, removing the echo received from each conference party prior to summing the received audio.

5.2 Echo Cancellation Features

Echo cancellation support is available for circuit-switched connections that may contain electrical echo on the received media stream. This feature is applicable to Dialogic® HMP Interface Boards that provide public switched telephone network (PSTN) connectivity for Dialogic® HMP software when on-board echo cancellation is not available or is not used. This feature is also referred to as host-based echo cancellation; that is, the echo canceller is in the host software.

Echo cancellation support is in compliance with ITU-T G.168 recommendation and can be controlled using runtime API functions or CONFIG file parameters. It is recommended that you control echo cancellation on a channel by channel basis using runtime API functions when they are available.

Echo Cancellation

Echo cancellation capability is provided on the following devices in Dialogic® Host Media Processing (HMP) Software:

- IP media device
- signal detector of the voice device
- conferencing device
- CSP/voice device

5.3 Using Echo Cancellation

Enabling the echo cancellation feature in certain devices (IP media, voice, conferencing, and continuous speech processing) in Dialogic® HMP software is typically required when these devices receive media streams from the public switched telephone network (PSTN) via the DTI devices on the Dialogic® HMP Interface Boards.

Note: DTI devices refer to digital network interface devices, which is used interchangeably with digital trunk interface devices.

While T1/E1 interfaces are digital interfaces, analog links may be part of the end-to-end connections. When this is the case, electrical echo may be present unless the PSTN provides echo cancellation on the connection, which it does not normally do. The echo cancellation feature only addresses electrical echo. It does not address acoustic echo which is typically handled by the handsets (telephones) where acoustic echo could potentially be introduced into the network. See [Section 5.1, “Echo Cancellation Background Information”](#), on page 41 for an overview of echo cancellation and the types of echo.

Enabling the echo cancellation feature in the devices mentioned earlier in this section is **not required** for the following:

- Media streams received from PSTN connections via Dialogic® HMP Interface Boards that have on-board echo cancellation that is available and enabled. Echo cancellation is provided as part of the DTI resources.

For information about enabling and disabling echo cancellation on these boards, see [Section 5.6, “Configuring On-Board Echo Cancellation”](#), on page 52.

For information about board support, see [Chapter 2, “Feature Support by Platform”](#).

- Media streams received from the IP packet network via IP media devices. Due to the delays associated with the packet network, echo must be removed prior to transmitting voice (audio) onto the packet network. This is the responsibility of IP endpoints such as gateways and IP phones. Therefore, it is assumed that the media streams received from the IP packet network are free of any objectionable echo.

Since the echo cancellation feature consumes CPU resources, echo cancellation should only be applied when needed. For this reason, runtime application control is available to enable and disable host-based echo cancellation on a per connection or per channel basis. See [Section 5.4, “Configuring Host-Based Echo Cancellation”](#), on page 45 for more information.

5.4 Configuring Host-Based Echo Cancellation

Host-based echo cancellation can be configured on one or more devices as needed. The following topics provide more information about configuring host-based echo cancellation:

- [Echo Cancellation on IP Media Devices](#)
- [Echo Cancellation on Voice Devices](#)
- [Echo Cancellation on Conferencing Devices](#)
- [Echo Cancellation on CSP/Voice Devices](#)

Note: The information in the following subsections does not apply to Dialogic® HMP Interface Boards. For information about enabling and disabling echo cancellation settings on these boards, see [Section 5.6, “Configuring On-Board Echo Cancellation”](#), on page 52.

5.4.1 Echo Cancellation on IP Media Devices

The IP media device supports echo cancellation on tail lengths up to 64 ms. The default echo cancellation settings on IP media devices are as follows: echo cancellation is disabled, non-linear processing (NLP) is enabled, and the tail length is 16 ms.

Echo cancellation features of the IP media device can be managed using the Dialogic® IP Media Library API or the Dialogic® Global Call API library.

Dialogic® IP Media Library API

Echo cancellation features of the IP media device can be controlled and monitored using Dialogic® IP Media Library API functions.

Echo cancellation can be turned on or off on a per channel (device) basis using **ipmSetParm()** in conjunction with `PARMCH_ECACTIVE` in the `IPM_PARM_INFO` structure.

The echo cancellation tail length can be set using **ipmSetParm()** in conjunction with `PARMCH_ECHOTAIL` in the `IPM_PARM_INFO` structure.

The echo cancellation NLP feature can be turned on or off using **ipmSetParm()** in conjunction with `PARMCH_ECNLP_ACTIVE` in the `IPM_PARM_INFO` structure.

Echo cancellation settings can be monitored using **ipm_GetParm()** in conjunction with the following in the `IPM_PARM_INFO` structure: `PARMCH_ECACTIVE`, `PARMCH_ECHOTAIL`, and `PARMCH_ECNLP_ACTIVE`.

The following usage rules apply:

- NLP can only be disabled after echo cancellation has been enabled and the **ipm_StartMedia()** function has been invoked.
- Disabling echo cancellation, invoking the **ipm_Stop()** function, or invoking the **ipm_ModifyMedia()** function will cause NLP to be reset to the enabled state. Therefore, if NLP needs to be disabled, you must invoke **ipm_SetParm()** to disable NLP each time the

Echo Cancellation

ipm_StartMedia() or **ipm_ModifyMedia()** is invoked. This assumes that echo cancellation was previously enabled.

- If echo cancellation was also disabled, echo cancellation must be re-enabled either before or after invoking **ipm_StartMedia()** or **ipm_ModifyMedia()**. In either case, echo cancellation must also be enabled before **ipm_SetParm()** is invoked to disable NLP.

For more information, see the Dialogic® IP Media API Library documentation.

Dialogic® Global Call API Library

Alternatively, echo cancellation features of the IP media device can be controlled using the Dialogic® Global Call API Library.

Echo cancellation settings can be modified using the **gc_SetUserInfo()** function to set Dialogic® IP Media Library parameters via the GC_PARM_BLK structure. You can set any IP media parameter in the GC_PARM_BLK structure by using **gc_util_insert_parm_ref()** with a set id of IPSET_CONFIG and parameter IDs of IPPARM_IPMPARM with a value as a pointer to the IPM_PARM_INFO structure.

The echo cancellation parameters that may be modified include PARMCH_ECACTIVE, PARMCH_ECHOTAIL, and PARMCH_ECNLP_ACTIVE.

The following usage rule applies:

- NLP can only be disabled after echo cancellation has been enabled and an active call has been established. Upon termination of a call, NLP will be reset to the enabled state. Therefore, if NLP needs to be disabled, the **gc_SetUserInfo()** function will need to be invoked to disable NLP each time a new call is established with echo cancellation enabled.

For more information, refer to the Dialogic® Global Call API Library documentation.

5.4.2 Echo Cancellation on Voice Devices

The signal detector of the voice resource supports echo cancellation on tail lengths up to 8 ms. By default, echo cancellation is disabled. The echo cancellation tail length cannot be modified.

Dialogic® Voice API Library

Echo cancellation features of the voice device can be controlled and monitored using the Dialogic® Voice API library.

Echo cancellation can be turned on or off on a per channel (device) basis using **dx_setparm()** in conjunction with DXCH_EC_ACTIVE.

Echo cancellation settings can be monitored using **dx_getparm()** in conjunction with DXCH_EC_ACTIVE.

For more information, refer to the Dialogic® Voice API library documentation.

5.4.3 Echo Cancellation on Conferencing Devices

The conferencing device supports echo cancellation on a per party basis for tail lengths up to 64 ms. By default, echo cancellation is disabled, and the default tail length is set to 16 ms.

Echo cancellation features of the conferencing device can be managed using the Dialogic® Conferencing (CNF or DCB) API library and the CONFIG file for Dialogic® HMP software.

Dialogic® Conferencing (CNF) API Library

Echo cancellation features of the CNF conferencing device can be controlled using the **cnf_SetAttributes()** function. For more information, see the Dialogic® Conferencing (CNF) API Library documentation.

Dialogic® Conferencing (DCB) API Library

Echo cancellation features of the DCB conferencing device can be controlled using Dialogic® Conferencing (DCB) API library functions.

Echo cancellation is disabled by default but can be enabled on a per party basis when establishing a conference using the **dcb_estconf()** function or, when adding a party to a conference using the **dcb_addtoconf()** function.

The **dcb_estconf()** function uses an array of MS_CDT data structures which define the attributes of the conference parties. The **dcb_addtoconf()** function uses a single MS_CDT structure to define the attributes of the party that is being added to the conference.

The **chan_attr** field in the MS_CDT structure is a bitmask that specifies the party's properties within the conference. The bit that enables echo cancellation is **MSPA_ECHOCLEN**.

The conferencing device echo cancellation tail length and NLP capability cannot be controlled by the conferencing API, but can be controlled using the CONFIG (.*config*) file. For more information, see [CONFIG File for Dialogic® HMP software](#).

For more information on conferencing functions and data structures, refer to the Dialogic® Conferencing (DCB) API Library documentation.

CONFIG File for Dialogic® HMP software

You can modify the conferencing device echo cancellation tail length by editing the CONFIG (.*config*) file. The tail length setting, however, applies globally to all conferencing channels (devices). The setting also modifies the default value for continuous speech processing (CSP) devices, but the CSP values can be changed on a per channel basis using CSP APIs.

The following line in the CONFIG file allows the echo cancellation tail length to be modified:

Echo Cancellation

```
[0x2c]
```

```
SetParm=0x2c03,128 ! Set EC tail length to 64(8ms), 80(10ms),  
128(16ms),192(24ms), 256(32ms), 512(64ms). Default: 128(16ms)
```

You can enable or disable the conferencing device echo cancellation non-linear processing (NLP) feature by editing the CONFIG file. The NLP setting, however, applies globally to all conferencing channels (devices). The setting also modifies the default value for CSP, but the CSP values can be changed on a per channel basis using CSP APIs.

The following line in the CONFIG file allows the echo cancellation NLP feature to be enabled or disabled:

```
[0x2c]
```

```
SetParm=0x2c01, 0x1 ! Enable Echo Canceller NLP (0x1 (enable-default),  
0x0 (disable))
```

After editing the CONFIG file, you must generate a new FCD file for the changes to take effect. For more information, see [Section 4.6, “Modifying the FCD File Parameters”](#), on page 36.

5.4.4 Echo Cancellation on CSP/Voice Devices

The CSP/voice device supports echo cancellation on tail lengths up to 64 ms. By default, echo cancellation is disabled, and the default tail length is 16 ms.

Note: Modifying echo cancellation related conferencing parameters in the CONFIG file will change corresponding default CSP echo cancellation parameter values.

Dialogic® Continuous Speech Processing API Library

Echo cancellation features of the CSP/voice device can be controlled and monitored using Dialogic® CSP API library functions.

Echo cancellation can be turned on or off on a per channel (device) basis using **ec_setparm()** in conjunction with ECCH_ECHOCANCELLER.

The echo cancellation tail length can be set on a per channel (device) basis using **ec_setparm()** in conjunction with DXCH_EC_TAP_LENGTH.

The echo cancellation non-linear processing (NLP) feature can be turned on or off on a per channel (device) basis using **ec_setparm()** in conjunction with ECCH_NLP.

Echo cancellation settings can be monitored using **ec_getparm()** in conjunction with the following parameters: ECCH_ECHOCANCELLER, DXCH_EC_TAP_LENGTH, and ECCH_NLP.

For more information, refer to the Dialogic® Continuous Speech Processing API Library documentation.

5.5 Host-Based Echo Cancellation Sample Scenarios

The following examples illustrate the digital network interface (DTI) devices connected to various Dialogic® HMP software resources as well as IP only connections.

- DTI and IP Gateway Example
- DTI and IP Conferencing Example
- DTI and CSP/Voice Example
- DTI and Voice Example
- IP and IP Connection Example
- IP and CSP/Voice Example
- IP and Voice Example

Note: These examples do not apply to Dialogic® HMP Interface Boards that have on-board echo cancellation that is available and enabled. For information about board and feature support, see Chapter 2, “Feature Support by Platform”.

5.5.1 DTI and IP Gateway Example

Figure 11 shows an example of a T1/E1 and IP Gateway connection formed by connecting the DTI device to an IP media device, also called an IPM device. In this example, the echo cancellation feature (EC) of the IP media device is enabled, to handle echo on the media stream received from the PSTN via the DTI device.

Figure 11. T1/E1 Gateway Example



5.5.2 DTI and IP Conferencing Example

Figure 12 shows a four-party conferencing example where two DTI devices are connected to the conference as parties A and B, and two IP media devices are connected to the conference as parties C and D.

The echo cancellation feature (EC) of the conference device is enabled for parties A and B, to handle echo on the media stream received from the PSTN via the DTI devices. The EC feature is disabled for parties C and D, and also for both IP media devices.

Figure 12. DTI and IP Conferencing Example

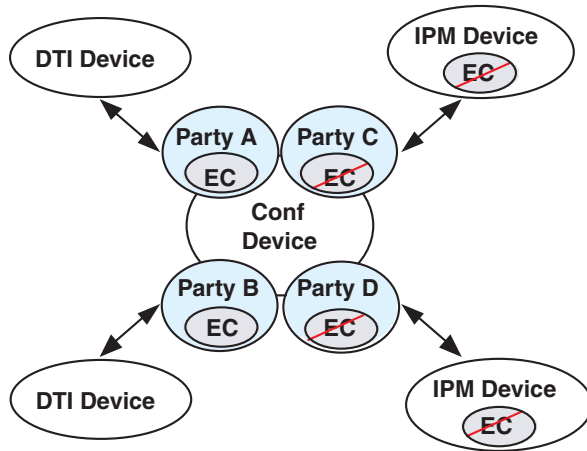

5.5.3 DTI and CSP/Voice Example

Figure 13 shows an example where the DTI device is connected to a CSP/voice device. The echo cancellation feature (EC) of the CSP/voice device is enabled, to handle echo on the media stream from the PSTN received via the DTI device.

Figure 13. DTI and CSP/Voice Example

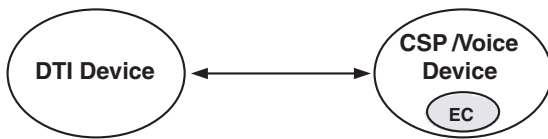

5.5.4 DTI and Voice Example

Figure 14 shows an example where the DTI device is connected to a voice device. The echo cancellation feature (EC) of the voice device is enabled, to handle echo on the media stream from the PSTN received via the DTI device.

Figure 14. DTI and Voice Example

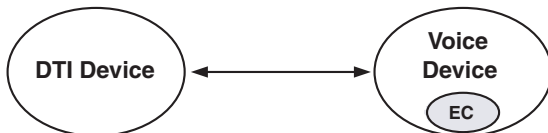

5.5.5 IP and IP Connection Example

Figure 15 shows an IP to IP connection example. The echo cancellation feature (EC) is disabled for both IP media devices. As discussed in [Section 5.1.3, “Electrical Echo”](#), on page 42, echo must be removed from the media stream prior to its transmission on the IP packet network.

Figure 15. IP and IP Connection Example

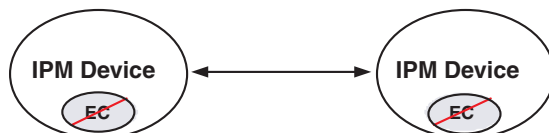

5.5.6 IP and CSP/Voice Example

Figure 16 shows an example where the IP media device is connected to a CSP/voice device. The echo cancellation feature (EC) of both the CSP/voice device and the IP media device is disabled. As discussed in [Section 5.1.3, “Electrical Echo”](#), on page 42, echo must be removed from the media stream prior to its transmission on the IP packet network.

Figure 16. IP and CSP/Voice Example

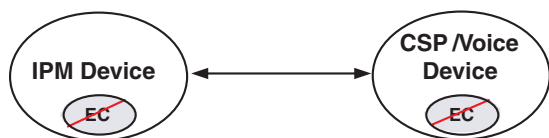

5.5.7 IP and Voice Example

Figure 17 shows an example where the IP media device is connected to a voice device. The echo cancellation feature (EC) of both the voice device and the IP media device is disabled. As discussed in [Section 5.1.3, “Electrical Echo”](#), on page 42, echo must be removed from the media stream prior to its transmission on the IP packet network.

Figure 17. IP and Voice Example



5.6 Configuring On-Board Echo Cancellation

This section applies to Dialogic® HMP Interface Boards that have on-board echo cancellation, where echo cancellation is provided as part of the DTI resources. For information about board support, see [Chapter 2, “Feature Support by Platform”](#).

The `gc_SetConfigData()` function in the Dialogic® Global Call API library allows the application to dynamically set echo cancellation parameters, namely enabled/disabled and Non-Linear Processing (NLP), on a per channel basis at run time. Use the `gc_GetConfigData()` function to return the current values for a given line device (channel basis).

The following definitions are used for enabling and disabling echo cancellation:

```
Set ID: CCSET_DM3FW_PARM
Parm Id: CCPARM_ECHOCANCEL
Valid Values: CCDM3FW_PARMECHOCANCEL_DISABLE 0x0
              CCDM3FW_PARMECHOCANCEL_ENABLE 0x1
              CCDM3FW_PARMECHOCANCEL_ENABLE_NLP 0x2
```

The target type is `GCTGT_CCLIB_CHAN`, where the target value is the linedev handle.

Using the `CCSET_DM3FW_PARM` set ID and the echo cancellation defines, you can set up the DTI channels with echo cancellation capability. These echo cancellation values can be combined as a bitmask to create the following modes of echo cancellation:

Parameter ID	Value	Description
<code>CCDM3FW_PARMECHOCANCEL_DISABLE</code>	0x0	No echo cancellation
<code>CCDM3FW_PARMECHOCANCEL_ENABLE</code>	0x1	Echo cancellation enabled
<code>CCDM3FW_PARMECHOCANCEL_ENABLE CCDM3FW_PARMECHOCANCEL_ENABLE_NLP</code>	0x3	Echo cancellation enabled, NLP enabled

Note: The following values are not supported and will return an error if used:

```
CCDM3FW_PARMECHOCANCEL_ENABLE_NLP
CCDM3FW_PARMECHOCANCEL_DISABLE | CCDM3FW_PARMECHOCANCEL_ENABLE_NLP
```

Example

```
...
GC_PARM_BLKP echo_blkp = NULL;
int req_id;
...

/* insert parm by value */
if ( gc_util_insert_parm_val( &echo_blkp, CCSET_DM3FW_PARM, CCPARM_ECHOCANCEL, sizeof( char ),
(char)(CCDM3FW_PARMECHOCANCEL_ENABLE | CCDM3FW_PARMECHOCANCEL_ENABLE_NLP) ) != GC_SUCCESS )
{
```

```
    sprintf(str, "gc_util_insert_parm_val(CCSET_DM3FW_PARM, CCPARM_ECHOCANCEL, sizeof( char ),  
(char)CCDM3FW_PARMECHOCANCEL_ENABLE) Failed");  
    printandlog(index, GC_APIERR, NULL, str, 0);  
    exitdemo(1);  
}  
  
/* Enable Echo Cancellation */  
if (gc_SetConfigData(GCTGT_CCLIB_CHAN, port[index].ldev, echo_blkp, 0, GCUPDATE_IMMEDIATE,  
&req_id, EV_ASYNC) != GC_SUCCESS) {  
    sprintf(str, "gc_SetConfigData(GCTGT_CCLIB_CHAN, targetID:0x%x, mode:EV_ASYNC Failed",  
port[index].ldev);  
    printandlog(index, GC_APIERR, NULL, str, 0);  
    exitdemo(1);  
}  
/* delete parm blk */  
...
```

Dialogic® Configuration Manager (DCM) Parameter Reference

6

This section lists and describes all parameters contained in the Dialogic® Configuration Manager (DCM). Parameters are grouped by the property sheet on which they reside. Property sheets are described in alphabetical order and include the following:

- Bridge Controller Property Sheet 54
- Bridge Device Configuration Property Sheet 55
- Driver Property Sheet 59
- Logical Property Sheet 61
- Misc Property Sheet. 61
- Physical Property Sheet 65
- TDM Bus Configuration Property Sheet 70
- Trunk Configuration Property Sheet 79
- Version (Version Info.) Property Sheet 81

Note: Not all property sheets or parameters within a property sheet apply to all boards.

6.1 Bridge Controller Property Sheet

The Bridge Controller property sheet contains parameters for configuring a bridge device on a DNI board. Each board has a bridge device that enables communication and media streaming between the Dialogic® HMP Software and the boards on the CT Bus. The media stream connections are managed by the bridge controller. To access the Bridge Controller property sheet, expand Bridge Devices on the DCM main window and double-click on the Bridge-0 device.

The parameters on the Bridge Controller property sheet include:

- SystemMaxHBStreams
- SystemMaxBHStreams
- BridgeControllerNumberOfHSIHOLDBuffers

SystemMaxHBStreams

Description: The SystemMaxHBStreams parameter, a read-write parameter, controls the maximum number of streams in the system to be allocated in the Dialogic® HMP Software to Board direction.

Values: 0, 1, 2, 4, 8, 16, 32, 64, 128, 192, 256, 320, 384, 448, 512 [default]

Guidelines: This parameter is used for optimizing performance. To conserve resources, set this parameter to match the number of channels in your Dialogic® HMP Software system. For example, if a Dialogic® HMP Software system with Dialogic® HMP Interface Boards provides up to 240 channels of media resources, setting this parameter to a value lower than the default of 512 streams will save resources that would otherwise be used for bridging and streaming. In this case, you can set this value to 256.

SystemMaxBHStreams

Description: The **SystemMaxBHStreams** parameter, a read-write parameter, controls the maximum number of streams in the system to be allocated in the Board to Dialogic® Host Media Processing (HMP) Software direction.

Values: 0, 1, 2, 4, 8, 16, 32, 64, 128, 192, 256, 320, 384, 448, 512 [default]

Guidelines: This parameter is used for optimizing performance. To conserve resources, set this parameter to match the number of channels in your Dialogic® HMP Software system. For example, if a Dialogic® HMP Software system with interface boards provides up to 240 channels of media resources, setting this parameter to a value lower than the default of 512 streams will save resources that would otherwise be used for bridging and streaming. In this case, you can set this value to 256.

BridgeControllerNumberOfHSIHOLDBuffers

Description: The **BridgeControllerNumberOfHSIHOLDBuffers** parameter, a read-write parameter, controls the number of Host Streaming Interface (HSI) hold buffers. These are buffers between the Dialogic® HMP Software device on the host and the CT Bus on an interface board. The HSI hold buffers are used to prevent data loss by temporarily holding any overflow media data when there is peak activity on the host.

A set of HSI hold buffers exists for the Board to Host direction and another set for the Host to Board direction. This parameter specifies the number to be used for both sets. For example, if this parameter is set to 4, then 4 HSI hold buffers are available for the Board to Host direction, and another 4 HSI hold buffers are available for the Host to Board direction.

Values: 3 [default], 4, 5

Guidelines: None.

6.2 Bridge Device Configuration Property Sheet

The Bridge Device Configuration property sheet contains parameters for configuring bridging and streaming functionality on a DNI board. Each DNI board has a bridge device that enables communication and media streaming between Dialogic® HMP Software and the boards on the CT Bus.

The parameters on the Bridge Device Configuration property sheet include:

- [BridgeDeviceId](#)
- [BridgeDeviceType](#)
- [BridgeDeviceEnabled](#)

Dialogic® Configuration Manager (DCM) Parameter Reference

- [BridgeDeviceStatus](#)
- [BridgeDeviceHMPClockMaster](#)
- [BridgeDeviceHMPClockMasterFallbackNbrUserDefined](#)
- [BridgeDeviceHMPClockMasterFallbackNbrResolved](#)
- [BridgeDeviceHBStreamCapacity](#)
- [BridgeDeviceBHStreamCapacity](#)
- [BridgeDeviceMaxHBStreamSetting](#)
- [BridgeDeviceMaxBHStreamSetting](#)
- [BridgeDeviceMultiBridgeSynchPattern](#)

BridgeDeviceId

Description: The **BridgeDeviceId** parameter, a read-only parameter, displays a unique id associated with the bridge device. It is set to the Addressable Unit Identifier (AUID) of the board that contains the bridge device. The AUID can be correlated with events associated with the bridge device. See the *Dialogic® Event Service API Library Reference* and *Dialogic® Event Service API Programming Guide* for more information about bridge device events.

Values: A positive integer up to a maximum value of a 32-bit integer

Guidelines: None. This is a read-only parameter.

BridgeDeviceType

Description: The **BridgeDeviceType** parameter, a read-only parameter, indicates the type of bridge device provided by the DNI board.

Values:

- **SoftBus/CTBusBridgeDevice** [default]: indicates that the device bridges the soft bus, which is used by Dialogic® HMP Software, and the CT Bus. With Dialogic® HMP Software, no physical TDM bus exists but its functionality is implemented in the software; the term “soft bus” refers to this functionality.
- **DedicatedBridgeDevice**: indicates that the device bridges the soft bus and devices such as network interface ports on the associated DNI board.

Guidelines: None. This is a read-only parameter.

BridgeDeviceEnabled

Description: The **BridgeDeviceEnabled** parameter, a read/write parameter, controls whether a bridge device is enabled or disabled. After making a change to this parameter value, you must stop the board which contains the bridge device, and subsequently restart it for the change to take effect.

Values:

- Yes [default]
- No

Guidelines: None.

BridgeDeviceStatus

Description: The **BridgeDeviceStatus** parameter, a read-only parameter, displays the status of a bridge device.

Values:

- Stopped [default]
- Starting
- Started
- Stopping

Guidelines: None. This is a read-only parameter.

BridgeDeviceHMPClockMaster

Description: The **BridgeDeviceHMPClockMaster** parameter, a read-only parameter, indicates whether or not this device is the clock master. The clock master provides the clocking to Dialogic® HMP Software.

Values:

- Yes
- No [default]

Guidelines: None. This is a read-only parameter.

BridgeDeviceHMPClockMasterFallbackNbrUserDefined

Description: The **BridgeDeviceHMPClockMasterFallbackNbrUserDefined** parameter, a read/write parameter, sets the user's preference for the HMPClockMasterFallbackNbr. A bridge device with the lowest number is chosen by the bridge controller as the clock master. When multiple boards have the same value, the bridge controller chooses the bridge device that will be the Dialogic® HMP Software clock master first. The bridge controller reports the number that it's using and writes this number to the **BridgeDeviceHMPClockMasterFallbackNbrResolved** parameter. The user-defined value may not match the resolved value for a bridge device in cases where multiple bridge devices are assigned the same number.

Values: 0 through 15 (integer).

Guidelines: The default value for DNI boards is 3. In general, it is recommended that you use the default value provided by the system for your board. However, you can select a specific board to be the Dialogic® HMP Software clock master if desired.

BridgeDeviceHMPClockMasterFallbackNbrResolved

Description: The **BridgeDeviceHMPClockMasterFallbackNbrResolved** parameter, a read-only parameter, is the number that the bridge controller uses for this bridge device. See the description of the **BridgeDeviceHMPClockMasterFallbackNbrUserDefined** parameter for more information.

Values: 0 through 15 (integer). No default value.

Guidelines: None. This is a read-only parameter.

BridgeDeviceHBStreamCapacity

Description: The **BridgeDeviceHBStreamCapacity** parameter, a read-only parameter, displays the HMP to Board stream capacity of the bridge device on this board. This value is the maximum number of streams that the board supports. To lower the number of streams that the board allows, use the **BridgeDeviceMaxHBStreamSetting** parameter.

Values: 0, 1, 2, 4, 8, 16, 32, 64, 128, 192, 256 [default], 320, 384, 448, 512

Guidelines: None. This is a read-only parameter.

BridgeDeviceBHStreamCapacity

Description: The **BridgeDeviceBHStreamCapacity** parameter, a read-only parameter, displays Board to Dialogic® HMP Software stream capacity of the bridge device on this board. This value is the maximum number of streams that the board supports. To lower the number of streams that the board allows, use the **BridgeDeviceMaxBHStreamSetting** parameter.

Values: 0, 1, 2, 4, 8, 16, 32, 64, 128, 192, 256 [default], 320, 384, 448, 512

Guidelines: None. This is a read-only parameter.

BridgeDeviceMaxHBStreamSetting

Description: The **BridgeDeviceMaxHBStreamSetting** parameter, a read/write parameter, specifies the number of Dialogic® HMP Software to Board streams for the bridge device to use. This allows you to specify a number less than the **BridgeDeviceHBStreamCapacity**.

Values: 0, 1, 2, 4, 8, 16, 32, 64, 128, 192, 256 [default], 320, 384, 448, 512

Guidelines: This parameter can be used to distribute the system streaming load more evenly between multiple capable boards in the system. For example, if a system requires 240 Dialogic® HMP Software to Boards streams, two boards can handle this load with each board set to 128 Dialogic® HMP Software to Board streams.

BridgeDeviceMaxBHStreamSetting

Description: The **BridgeDeviceMaxBHStreamSetting** parameter, a read/write parameter, specifies the number of Board to Dialogic® HMP Software streams for the bridge device to use. This allows you to specify a number less than the **BridgeDeviceBHStreamCapacity**.

Values: 0, 1, 2, 4, 8, 16, 32, 64, 128, 192, 256 [default], 320, 384, 448, 512

Guidelines: This parameter can be used to distribute the system streaming load more evenly between multiple capable boards in the system. For example, if a system requires 240 Boards to Dialogic® HMP Software streams, two boards can handle this load with each board set to 128 Board to Dialogic® HMP Software streams.

BridgeDeviceMultiBridgeSynchPattern

Description: The **BridgeDeviceMultiBridgeSynchPattern** parameter, a read-only parameter, displays the bridge device MultiBridge Synch Pattern. This contains the four-byte

synchronization pattern that is used to align the Rate Interrupt and the data moving between the Host and the Board for multiple bridge devices.

Values: (ASCII zero)

- 0x00000001 [default]
- 0x00000002
- 0x00000041
- 0x00000042

Guidelines: None. This is a read-only parameter.

6.3 Driver Property Sheet

The Driver property sheet allows you to optimize the board's throughput by customizing certain aspects of the board's device driver. The Driver property sheet contains the following parameters:

- [doDMA](#)
- [freeOrphanOnDepletion](#)
- [maxOrphanStrmSize](#)
- [orphanageMsgLen](#)
- [orphanageMsgTimeout](#)
- [orphanStrmTableSize](#)
- [outStrmQuantum](#)
- [sramInQuantum](#)
- [sramOutQuantum](#)
- [sramOutTimer](#)

doDMA

Description: The **doDMA** parameter indicates whether DMA (direct memory access) read access is enabled or disabled.

Values:

- 0: Off (DMA read access is disabled)
- 1 [default]: On (DMA read access is enabled)

freeOrphanOnDepletion

Description: The **freeOrphanOnDepletion** parameter specifies whether the protocol driver frees the orphan buffer after it has been read completely.

Values:

- 0 [default]: No (do not free the orphan buffer)
- 1: Yes (free the orphan buffer)

maxOrphanStrmSize

Description: The **maxOrphanStrmSize** parameter specifies the maximum size, in bytes, of each orphan stream buffer. When this value is set to 0, the protocol driver attempts to allocate as much buffer as possible.

Values: A positive integer (byte). The default value is 0.

Guidelines: Use the **maxOrphanStrmSize** parameter default value.

orphanageMsgLen

Description: The **orphanageMsgLen** parameter specifies the maximum size, in bytes, of the message orphan buffer.

Values: 8096 to 32768 (bytes). The default value is 8192.

Guidelines: Use the **orphanageMsgLen** parameter default value.

orphanageMsgTimeout

Description: The **orphanageMsgTimeout** parameter specifies the time out, in seconds, for orphan messages.

Values: 3 to 180 (seconds). The default value is 30.

Guidelines: Use the **orphanageMsgTimeout** parameter default value.

orphanStrmTableSize

Description: The **orphanStrmTableSize** parameter specifies the maximum number of streams in the orphan table.

Values: A positive integer. The default value is 256.

Guidelines: Use the **orphanStrmTableSize** parameter default value.

outStrmQuantum

Description: The **outStrmQuantum** parameter specifies the maximum number of outbound data blocks per stream. The protocol driver uses this value during its outbound session to allow all ready streams equal priority to the SRAM.

Values: 1 to 10 (The default value is 1.)

Guidelines: Use the **outStrmQuantum** parameter default value.

sramInQuantum

Description: The **sramInQuantum** parameter specifies the maximum number of inbound data blocks for all streams. The protocol driver uses this value during an inbound session to cap the total number of data blocks read from the SRAM. When this parameter is set to 0, there is no limit for inbound data blocks for all streams.

Values: 0 to 120 (The default value is 0.)

Guidelines: Use the `sramInQuantum` parameter default value.

sramOutQuantum

Description: The `sramInQuantum` parameter specifies the maximum number of outbound data blocks for all streams. The protocol driver uses this value during an outbound session to cap the total number of data blocks written to the SRAM.

Values: 1 to 120 (The default value is 120.)

Guidelines: Use the `sramOutQuantum` parameter default value.

sramOutTimer

Description: The `sramOutTimer` parameter specifies the outbound timer rate in milliseconds.

Values: 1 to 100 (milliseconds). The default value is 30.

Guidelines: Use the `sramOutTimer` parameter default value.

6.4 Logical Property Sheet

The Logical property sheet contains the following parameters:

- [CurrentState](#)

CurrentState

Description: The `CurrentState` parameter is a read-only parameter that specifies the current state of the board.

Values:

- Initialized: Board detected
- Reset: Board reset by downloader
- ConfigPending: Board configuration pending
- Configured: Board configuration complete
- Running: Board running
- Quiescent: Board I/O activities have been closed in preparation for a shutdown
- Shutdown: Board stopped

Guidelines: The `CurrentState` parameter is read-only and cannot be modified by the user.

6.5 Misc Property Sheet

The Misc property sheet contains miscellaneous parameters that include the following:

- [PassiveMode](#)
- [Board monitoring frequency in seconds](#)

Dialogic® Configuration Manager (DCM) Parameter Reference

- BoardEnabled
- BoardPresent
- ProcessTimeout(Seconds)
- FCDFilename
- PCDFilename
- ReplyMsgTimeout
- TraceEnable
- TraceLevel
- AdministrativeStatus
- OperationalStatus
- Physical State
- PnPAutoDownload

PassiveMode

Note: The **PassiveMode** parameter is only applicable to the TDM Bus, Bus-0 device. Also, it is the only Misc property sheet parameter applicable to the Bus-0 device.

Description: The **PassiveMode** parameter specifies whether clocking faults are handled or ignored by the system software.

Values:

- True: The system software will not respond to clocking faults.
- False [default]: The system software handles clocking faults (such as, performing clock fallback)

Guidelines: Set **PassiveMode** parameter to False to implement clock fallback support.

Board monitoring frequency in seconds

Description: The **Board monitoring frequency in seconds** parameter specifies in seconds, the frequency at which the board status is monitored.

Values: Time (seconds). The default value is 10.

Guidelines: The **Board monitoring frequency in seconds** parameter is read/write.

BoardEnabled

Description: The **BoardEnabled** parameter specifies whether or not the system software should download firmware to activate the board.

Values:

- Yes [default]
- No

Guidelines: Set the **BoardEnabled** parameter to a value of No to temporarily suspend the use of a board.

BoardPresent

Description: The **BoardPresent** parameter indicates whether or not the board is physically present in the system and was detected by the system software. A value of No is displayed if you enter configuration data for a board that is not in the system or if a board is improperly installed or malfunctioning.

Values:

- Yes
- No

Guidelines: The **BoardPresent** parameter is read only and cannot be modified by the user.

ProcessTimeout(Seconds)

Description: The **ProcessTimeout(Seconds)** parameter specifies the amount of time in seconds that the downloader will wait for a child process to complete.

Values: 10 to 120 (seconds). The default value is 120.

FCDFilename

Description: The **FCDFilename** parameter specifies the name of a board's Feature Configuration Description (FCD) file. The purpose of the FCD file is to adjust the component settings that make up each product. Each board in the system requires an FCD file.

Values: A valid FCD file name.

Guidelines: To ensure that an applicable FCD file is downloaded to your board, use the Restore Device Defaults option from the DCM Action menu to invoke the Assign Firmware File dialog box. The Assign Firmware File dialog box allows you to select a PCD File to download to your board. When you select a PCD file from the Assign Firmware File dialog box's Available Firmware list, the system automatically selects the applicable FCD file.

PCDFilename

Description: The **PCDFilename** parameter specifies the name of a board's Product Configuration Description (PCD) file. The PCD file lists object files and maps them to specific processors, configures the kernel for each processor, and sets the number of component instances to run on each processor. Each board in the system requires a PCD file.

Values: A valid PCD file name.

Guidelines: To ensure that an applicable PCD file is downloaded to your board, use the Restore Device Defaults option from the DCM's Action menu to invoke the Assign Firmware File dialog box. The Assign Firmware File dialog box allows you to select a PCD File to download to your board. When you select a PCD file from the Assign Firmware File dialog box's Available Firmware list, the system automatically selects the applicable FCD file as well.

ReplyMsgTimeout

Description: The **ReplyMsgTimeout** parameter specifies the maximum time in seconds that the downloader will wait for a reply message.

Values: 10 to 30 (seconds). The default value is 10.

TraceEnable

Description: The **TraceEnable** parameter indicates whether trace logging of the download process is enabled or disabled. When trace logging is enabled, a log file called *brdn.log*, where *n* equals the board number, is created in *\bin* under INTEL_DIALOGIC_DIR, the environment variable for the directory in which the software is installed.

Values:

- 0: Off (trace logging is disabled) [default]
- 1: On (trace logging is enabled)

TraceLevel

Description: The **TraceLevel** parameter specifies the detail level of trace logging.

Values:

- 2 [default]: Display errors only
- 3: Display all details

AdministrativeStatus

Description: The **AdministrativeStatus** parameter indicates the status of the currently selected device.

Values:

- Initial: The software representation of the board is created when the board's **Physical State** parameter is *In_System_Locked*.
- Stopped: The currently selected device is not running
- Started: The currently selected device is running.
- StopPending: The system software is in the process of stopping the currently selected device.
- StartPending: The system software is in the process of starting the currently selected device.
- Disabled: The currently selected device is not started when the system is started.
- Diagnose: Diagnostics are currently being run on the device.

Guidelines: The **AdministrativeStatus** parameter is read only and cannot be modified by the user.

OperationalStatus

Description: The **OperationalStatus** parameter indicates the integrity of the currently selected device.

Values:

- Initial: The software representation of the board is created when the board's Physical State parameter is In_System_Locked.
- Ok: The currently selected device is operating normally.
- Degraded: The currently selected device is operating at a below optimum level.
- Failed: The currently selected device has failed. Use the Windows® Event Viewer to determine the nature of the problem.

Physical State

Description: The **Physical State** parameter indicates the physical state of a board.

Values:

- In_System_Locked: The board is fully installed and recognized by the system.
- Out_Of_System: The board has been physically removed from the system, but not from the registry (DCM database).
- In_System_Unlocked: The board is physically installed, but the handles are in the open position.

Guidelines: The **Physical State** parameter is read only and cannot be modified by the user.

PnPAutoDownload

Description: The **PnPAutoDownload** parameter determines whether or not the Plug and Play subsystem automatically starts the board when the system reboots.

Values:

- No [default]
- Yes

Guidelines: The **PnPAutoDownload** parameter should not be modified by the user. If System/Device Autostart (from the DCM Settings pull-down menu) is set to Detect and Start, then the system software automatically resets this parameter to Yes for all boards in your chassis.

6.6 Physical Property Sheet

The Physical property sheet contains parameters for configuring the way the board works with your system, for example, the memory address and interrupt used by the boards. The Physical property sheet contains the following parameters:

- [PhysicalSlotNumber](#)
- [AUID](#)
- [PciID](#)

Dialogic® Configuration Manager (DCM) Parameter Reference

- [PciSlotNumber](#)
- [PciBusNumber](#)
- [InstanceNumber](#)
- [LogicalID](#)
- [PhysicalShelf](#)
- [IntVector](#)
- [IRQLevel](#)
- [PLXlength](#)
- [PLXAddr](#)
- [SRAMlength](#)
- [SRAMAddr](#)
- [SRAMSize](#)
- [DlgcOUI](#)
- [PrimaryBoardID](#)
- [SecondaryBoardID](#)
- [SerialNumber](#)

PhysicalSlotNumber

Description: The **PhysicalSlotNumber** parameter specifies a board's rotary-switch setting. The rotary-switch setting for Dialogic® boards can be the same for all boards in the system if the value is set to 0.

Values: 0 to 15

Guidelines: Use the **PhysicalSlotNumber** parameter default value.

AUID

Description: The **AUID** parameter defines the Addressable Unit Identifier (AUID) of the Dialogic® board. The AUID is a unique string of numbers that identifies a system software component with which communications may be initiated. In the context of the DCM, the AUID is a unique identifier for a board.

Values: A positive integer or hexadecimal value

Guidelines: The **AUID** parameter is read only and cannot be modified by the user.

PciID

Description: The **PciID** parameter is a positive integer or hexadecimal value in which the lower 5 bits specify a board's rotary-switch setting. The rotary-switch setting for PCI boards can be the same for all boards in the system if the value is set to 0.

Values: A positive integer or hexadecimal value

Guidelines: The **PciID** parameter is set by the system software and should not be changed by the user.

PciSlotNumber

Description: The **PciSlotNumber** denotes the number of the slot in which the board is installed.

Values: A positive integer or hexadecimal value

Guidelines: The **PciSlotNumber** parameter is set by the system software and should not be changed by the user.

PciBusNumber

Description: The **PciBusNumber** parameter indicates the number of the bus on which the board is installed.

Values: A positive integer or hexadecimal value

Guidelines: The **PciBusNumber** parameter is set by the system software and should not be changed by the user.

InstanceNumber

Description: The **InstanceNumber** parameter is the driver-assigned ID used to identify a board in the system. Driver-assigned IDs start from 0 and ID assignments are made in the order in which the boards were detected when the system started.

Values: A positive integer.

Guidelines: The **InstanceNumber** parameter is set by the system software and should not be changed by the user.

LogicalID

Description: The **LogicalID** parameter is a user-assigned identification number used by the drivers to identify the board.

Values: A positive integer from 0 to 255. The default is the value of the **InstanceNumber** parameter.

Guidelines: If you uninstall and then reinstall the system software without performing a backup and migration, there is no guarantee that the previously assigned logical ID numbers will be preserved.

PhysicalShelf

Description: The **PhysicalShelf** parameter denotes the number of the shelf in which the board is installed. Individual chassis can be assigned unique shelf identification numbers. The shelf identification number for a chassis can then be reported by any board that is plugged into the chassis backplane.

Values: A positive integer or hexadecimal value

Guidelines: The **PhysicalShelf** parameter is determined by the chassis. It cannot be modified through the DCM.

IntVector

Description: The **IntVector** parameter identifies the vector associated with the board interrupt.

Values: Vector number set by the system software.

Guidelines: The **IntVector** parameter is set by the system software and should not be changed by the user.

IRQLevel

Description: The **IRQLevel** parameter specifies the interrupt request level assigned to a board by the system.

Values: Interrupt request level set by the system software.

Guidelines: The **IRQLevel** parameter is set by the system software and should not be changed by the user.

PLXlength

Description: The **PLXlength** parameter is the number of consecutive addresses past the first assigned address. This parameter is for information purposes only.

Values: Positive number set by the system software.

Guidelines: The **PLXlength** parameter is set by the system software and should not be changed by the user.

PLXAddr

Description: The **PLXAddr** parameter is the physical address assigned to a board by the operating system. This parameter is for information purposes only.

Values: Physical address set by the system software.

Guidelines: The **PLXAddr** parameter is set by the system software and should not be changed by the user.

SRAMlength

Description: The **SRAMlength** parameter specifies the size, in bytes, of the shared RAM. This parameter is for information purposes only.

Values: A positive number (bytes) set by the system software.

Guidelines: The **SRAMlength** parameter is set by the system software and should not be changed by the user.

SRAMAddr

Description: The **SRAMAddr** parameter specifies the system's physical memory address assigned or mapped to the shared RAM.

Values: Memory address set by the system software.

Guidelines: The **SRAMAddr** parameter is set by the system software and should not be changed by the user.

SRAMSize

Description: The **SRAMSize** parameter The size, in bytes, of the physical shared RAM installed on a board.

Values: A positive number (bytes) set by the system software.

Guidelines: The **SRAMSize** parameter is set by the system software and should not be changed by the user.

DlgcOUI

Description: The **DlgcOUI** parameter specifies the unique ID number assigned to DM3 architecture boards (which include Dialogic® HMP Interface Boards), by the Institute of Electrical and Electronic Engineers (IEEE).

Values: Unique identification number set by the system software.

Guidelines: The **DlgcOUI** parameter is set by the system software and should not be changed by the user.

PrimaryBoardID

Description: The **PrimaryBoardID** parameter is the Product Assembly Type and Dialogic® DM3 Model Number assigned to a board.

Values: Model number set by the system software.

Guidelines: The **PrimaryBoardID** parameter is set by the system software and should not be changed by the user.

SecondaryBoardID

Description: The **SecondaryBoardID** parameter is used to further specify the Dialogic® DM3 Model Number assigned to the board.

Values: Model number set by the system software.

Guidelines: The **SecondaryBoardID** parameter is currently not used.

SerialNumber

Description: The **SerialNumber** parameter specifies the unique serial number of the board.

Values: Serial number set by the system software.

Guidelines: The **SerialNumber** parameter is set by the system software and should not be changed by the user.

6.7 TDM Bus Configuration Property Sheet

The TDM Bus Configuration property sheet contains parameters for configuring the TDM Bus. (For a discussion of TDM Bus concepts, see [Section 3.4, “CT Bus \(TDM\) Clocking”](#), on page 23.) User Defined parameters are provided in this section; Resolved equivalent parameters are not listed in this section. For more information about User Defined and Resolved equivalent parameters, refer to [Section 3.1.1, “TDM Bus Parameters”](#), on page 17.

Note: To access the TDM Bus Configuration property sheet, expand the TDM Bus device in the DCM main window, then double-click on the Bus-0 device. Do not access the TDM Bus Configuration property sheet when configuring a board device (by double-clicking on the board model from the DCM main window). When accessing the property sheet in this way, only a subset of parameters are viewable and they are all read only.

- [Attached to TDM Buses](#)
- [TDM Bus Type \(User Defined\)](#)
- [SCbus Clock Rate \(User Defined\)](#)
- [Media Type \(User Defined\)](#)
- [Group One Clock Rate \(User Defined\)](#)
- [Group Two Clock Rate \(User Defined\)](#)
- [Group Three Clock Rate \(User Defined\)](#)
- [Group Four Clock Rate \(User Defined\)](#)
- [Using Compatibility Clocks \(User Defined\)](#)
- [Primary Lines \(User Defined\)](#)
- [Using Primary Master \(User Defined\)](#)
- [Using Secondary Master \(User Defined\)](#)
- [Using NETREF One \(User Defined\)](#)
- [Using NETREF Two \(User Defined\)](#)
- [Primary Master FRU \(User Defined\)](#)
- [Derive Primary Clock From \(User Defined\)](#)
- [Secondary Master FRU \(User Defined\)](#)
- [Derive Secondary Clock From \(User Defined\)](#)
- [NETREF One FRU \(User Defined\)](#)
- [Derive NETREF One From \(User Defined\)](#)
- [NETREF One Clock Rate \(User Defined\)](#)
- [NETREF Two FRU \(User Defined\)](#)
- [Derive NETREF Two From \(User Defined\)](#)
- [NETREF Two Clock Rate \(User Defined\)](#)

Attached to TDM Buses

Description: The **Attached to TDM Buses** parameter is a read-only parameter that indicates to which TDM bus the currently selected device is attached.

Values: 0 to 20

TDM Bus Type (User Defined)

Description: The **TDM Bus Type (Resolved/User Defined)** parameter determines the bus mode for the currently selected TDM bus.

Values:

- Default [default]: The value of this parameter is to be determined by the system software.
- MVIP: The mode for the selected bus is MVIP.
- SCbus: The mode for the selected bus is SCbus.
- H.100: The mode for the selected bus is H.100.
- H.110: The mode for the selected bus is H.110.

Guidelines: Use the **TDM Bus Type (User Defined)** parameter default value. The value you set for this parameter may not be accepted by the system software. To determine the value that the system will use, check the value of the Resolved Equivalent.

SCbus Clock Rate (User Defined)

Description: The **SCbus Clock Rate (User Defined)** parameter determines the clock rate for the SCbus and only applies when the bus is running in SCbus mode (that is, when the **TDM Bus Type** parameter is set to SCbus).

Note: This parameter does not apply to Dialogic® DM3 architecture boards (which include DNI Boards).

Values:

- Default [default]: The value of this parameter is to be determined by the system software. Its current value is indicated by the Resolved Equivalent.
- 2MHz: The SCbus operates at 2 MHz.
- 4MHz: The SCbus operates at 4 MHz.
- 8MHz: The SCbus operates at 8 MHz.

Media Type (User Defined)

Description: The **Media Type (User Defined)** parameter determines the encoding method for the currently selected TDM bus.

Values:

- Default [default]: The value of this parameter is to be determined by the system software. Its current value is indicated by the Resolved Equivalent.
- ALaw: The encoding method is A-law (this is the method that should be used for E1 trunks).
- MuLaw: The encoding method is mu-law (this is the method that should be used for T1 trunks).
- ClearChannel: This value is currently not supported.

Group One Clock Rate (User Defined)

Description: The **Group One Clock Rate (User Defined)** parameter determines the clock rate for the first group of streams, in the first set of streams, in an H.100/H.110 bus. The first set of sixteen streams in the H.100/110 bus is divided into four groups of four streams each. Each group can operate at a different clock speed. (The second set of sixteen streams in the H.100/110 bus always operates at 8 MHz).

Values:

- Default [default]: The value of this parameter is to be determined by the system software. Its current value is indicated by the Resolved Equivalent.
- 2MHz: The first four-stream group operates at 2 MHz.
- 4MHz: The first four-stream group operates at 4 MHz.
- 8MHz: The first four-stream group operates at 8 MHz.

Group Two Clock Rate (User Defined)

Description: The **Group Two Clock Rate (User Defined)** parameter determines the clock rate for the second group of streams, in the first set of streams, in an H.100/H.110 bus. The first set of sixteen streams in the H.100/110 bus is divided into four groups of four streams each. Each group can operate at a different clock speed. (The second set of sixteen streams in the H.100/110 bus always operates at 8 MHz).

Values:

- Default [default]: The value of this parameter is to be determined by the system software. Its current value is indicated by the Resolved Equivalent.
- 2MHz: The second four-stream group operates at 2 MHz.
- 4MHz: The second four-stream group operates at 4 MHz.
- 8MHz: The second four-stream group operates at 8 MHz.

Group Three Clock Rate (User Defined)

Description: The **Group Three Clock Rate (User Defined)** parameter determines the clock rate for the third group of streams, in the first set of streams, in an H.100/H.110 bus. The first set of sixteen streams in the H.100/110 bus is divided into four groups of four streams each. Each

group can operate at a different clock speed. (The second set of sixteen streams in the H.100/110 bus always operates at 8 MHz).

Values:

- Default [default]: The value of this parameter is to be determined by the system software. Its current value is indicated by the Resolved Equivalent.
- 2MHz: The third four-stream group operates at 2 MHz.
- 4MHz: The third four-stream group operates at 4 MHz.
- 8MHz: The third four-stream group operates at 8 MHz.

Group Four Clock Rate (User Defined)

Description: The **Group Four Clock Rate (User Defined)** parameter determines the clock rate for the fourth group of streams, in the first set of streams, in an H.100/H.110 bus. The first set of sixteen streams in the H.100/110 bus is divided into four groups of four streams each. Each group can operate at a different clock speed. (The second set of sixteen streams in the H.100/110 bus always operates at 8 MHz).

Values:

- Default [default]: The value of this parameter is to be determined by the system software. Its current value is indicated by the Resolved Equivalent.
- 2MHz: The fourth four-stream group operates at 2 MHz.
- 4MHz: The fourth four-stream group operates at 4 MHz.
- 8MHz: The fourth four-stream group operates at 8 MHz.

Using Compatibility Clocks (User Defined)

Description: The **Using Compatibility Clocks (User Defined)** parameter indicates whether the Springware compatibility clock is used.

Note: This parameter does not apply to Dialogic® DM3 architecture boards (which include DNI Boards).

Values:

- Default [default]: The value of this parameter is to be determined by the system software. Its current value is indicated by the Resolved Equivalent.
- Yes: The compatibility clock is in use.
- No: The compatibility clock is not in use.

Primary Lines (User Defined)

Description: The **Primary Lines (User Defined)** parameter determines whether the Primary Line is Line A or Line B. The line that is not selected as the Primary Line serves as the Secondary Line.

Values:

- Default [default]: The value of this parameter is to be determined by the system software. Its current value is indicated by the Resolved Equivalent.
- A: The primary line is Line A.
- B: The primary line is Line B.

Using Primary Master (User Defined)

Description: The **Using Primary Master (User Defined)** parameter indicates whether or not the device specified by the **Primary Master FRU** parameter is the Clock Master for the currently selected bus. Use this parameter to take the Primary Master FRU offline in the event that it needs to be replaced.

Values:

- Default [default]: The value of this parameter is to be determined by the system software. Its current value is indicated by the Resolved Equivalent.
- No: The device specified by the Primary Master FRU parameter is not the Clock Master for the currently selected bus. This value is set by the system for a short period when the Primary Master FRU fails and the Secondary Master FRU is being promoted to bus master. Otherwise, this parameter cannot have the value No when the system is running.
- Yes: The device specified by the Primary Master FRU parameter is the Clock Master for the currently selected bus.

Using Secondary Master (User Defined)

Description: The **Using Secondary Master (User Defined)** parameter indicates whether or not the device specified by the **Secondary Master FRU** parameter is the Clock Master for the currently selected bus.

Values:

- Default [default]: The value of this parameter is to be determined by the system software. Its current value is indicated by the Resolved Equivalent.
- No: The device specified by the **Primary Master FRU** parameter is not the Clock Master for the currently selected bus. This value is set by the system for a short period when the Primary Master FRU fails and the Secondary Master FRU is being promoted to bus master. Otherwise, this parameter cannot have the value No when the system is running.
- Yes: The device specified by the **Secondary Master FRU** parameter is the Clock Master for the currently selected bus.

Using NETREF One (User Defined)

Description: The **Using NETREF One (User Defined)** parameter determines whether or not NETREF_1 is used as the source of clocking for the current Clock Master. This parameter

enables you to temporarily disconnect the network interface that drives NETREF_1 (as determined by the **Derive NETREF One From** parameter).

If this parameter is set to Yes, **Derive NETREF One From (Resolved)** is set to the value specified by **Derive NETREF One From (User Defined)** and **NETREF One FRU (Resolved)** is set to the value specified by **NETREF One FRU (User Defined)**.

Values:

- Default [default]: The value of this parameter is to be determined by the system software. Its current value is indicated by the Resolved Equivalent.
- No: NETREF_1 is not in use. (**Derive NETREF One From (Resolved)** and **NETREF One FRU (Resolved)** parameters are both set to Not Applicable.)
- Yes: NETREF_1 is in use. (**Derive NETREF One From (Resolved)** is set to the value specified by **Derive NETREF One From (User Defined)** and **NETREF One FRU (Resolved)** is set to the value specified by **NETREF One FRU (User Defined)**).

Using NETREF Two (User Defined)

Note: This parameter is not supported by Dialogic® HMP Software.

Description: The **Using NETREF Two (User Defined)** parameter determines whether or not NETREF_2 is used as the source of clocking for the current Clock Master. This parameter enables you to temporarily disconnect the network interface that drives NETREF_2 (as determined by the **Derive NETREF Two From** parameter).

Values:

- Default [default]: The value of this parameter is to be determined by the system software. Its current value is indicated by the Resolved Equivalent.
- No: NETREF_2 is not in use. (**Derive NETREF Two From (Resolved)** and **NETREF Two FRU (Resolved)** parameters are both set to Not Applicable.)
- Yes: NETREF_2 is in use. (**Derive NETREF Two From (Resolved)** is set to the value specified by **Derive NETREF Two From (User Defined)** and **NETREF Two FRU (Resolved)** is set to the value specified by **NETREF Two FRU (User Defined)**).

Primary Master FRU (User Defined)

Description: The **Primary Master FRU (User Defined)** parameter identifies the field replaceable unit (FRU) or technology that drives the clocking line specified by the **Primary Lines** parameter.

Values:

- Default [default]: The value of this parameter is to be determined by the system software. Its current value is indicated by the Resolved Equivalent.
- <device name>: Name of the device (board) that drives the TDM Bus clocking.

Guidelines: Do not use a board with front-end capability that is configured as resource only for the **Primary Master FRU**. Do not use the Dialogic® HMP Software virtual board for the **Primary Master FRU**. The Dialogic® HMP Software virtual board should always act as a slave.

Derive Primary Clock From (User Defined)

Description: The **Derive Primary Clock From (User Defined)** parameter specifies the clock source that the **Primary Master FRU** uses to drive the primary line.

Values:

- Default [default]: The value of this parameter is to be determined by the system software. Its current value is indicated by the Resolved Equivalent.
- FrontEnd_1: Not applicable to DNI Boards.
- FrontEnd_2: Not applicable to DNI Boards.
- FrontEnd_3: Not applicable to DNI Boards.
- FrontEnd_4: Not applicable to DNI Boards.
- InternalOscillator: The Primary Master derives clocking from its own internal circuitry.
- NETREF_1: The Primary Master derives clocking from NETREF_1.
- NETREF_2: *Note:* This selection is not supported for this release.

Secondary Master FRU (User Defined)

Description: The **Secondary Master FRU (User Defined)** parameter specifies the FRU or technology that drives clocking for the secondary line.

Values:

- Default [default]: The value of this parameter is to be determined by the system software. Its current value is indicated by the Resolved Equivalent.
- <device name>: Device name of an H.100/H.110-enabled FRU.

Guidelines: Do not use a board with front-end capability that is configured as resource only for the **Secondary Master FRU**. Do not use the Dialogic® HMP Software virtual board for the **Secondary Master FRU**. The Dialogic® HMP Software virtual board should always act as a slave.

Derive Secondary Clock From (User Defined)

Description: The **Derive Secondary Clock From (User Defined)** parameter specifies the clock source that the **Secondary Master FRU** uses to drive the Secondary Line.

Values:

- Default [default]: The value of this parameter is to be determined by the system software. Its current value is indicated by the Resolved Equivalent.
- InternalOscillator: The Secondary Master derives clocking from its own circuitry.
- NETREF_1: The Secondary Master derives clocking from NETREF_1.
- NETREF_2: This selection is not supported for this release.

NETREF One FRU (User Defined)

Description: The **NETREF One FRU (User Defined)** parameter identifies the FRU containing the interface to the network line that drives NETREF_1. This parameter identifies the Network Reference (NETREF) board, also known as the Reference Master board.

Values:

- Default [default]: The value of this parameter is to be determined by the system software. Its current value is indicated by the Resolved Equivalent.
- <device name>: Device name of an H.100/H.110-enabled FRU.

Derive NETREF One From (User Defined)

Description: The **Derive NETREF One From (User Defined)** parameter specifies the network interface that determines the clocking for the NETREF_1 line. The indicated interface is on the FRU designated by the NETREF One FRU parameter.

Values:

- Default [default]: The value of this parameter is to be determined by the system software. Its current value is indicated by the Resolved Equivalent.
- NetworkInterfaceOne: NETREF_1 is derived from interface 1 on the FRU designated by the **NETREF One FRU** parameter.
- NetworkInterfaceTwo: NETREF_1 is derived from interface 2 on the FRU designated by the **NETREF One FRU** parameter.
- NetworkInterfaceThree: NETREF_1 is derived from interface 3 on the FRU designated by the **NETREF One FRU** parameter.
- NetworkInterfaceFour: NETREF_1 is derived from interface 4 on the FRU designated by the **NETREF One FRU** parameter.

NETREF One Clock Rate (User Defined)

Description: The **NETREF One Clock Rate (User Defined)** parameter determines the clock rate for the NETREF_1 line.

Values:

- Default [default]: The value of this parameter is to be determined by the system software. Its current value is indicated by the Resolved Equivalent.
- 8KHz
- 1.536MHz
- 1.544MHz
- 2.048MHz

NETREF Two FRU (User Defined)

Note: This parameter is not supported by Dialogic® HMP Software.

Description: The **NETREF Two FRU (User Defined)** parameter identifies the FRU containing the interface to the network line that drives NETREF_2.

Values:

- Default [default]: The value of this parameter is to be determined by the system software. Its current value is indicated by the Resolved Equivalent.
- <device name>: Device name of an H.100/H.110-enabled FRU.

Derive NETREF Two From (User Defined)

Note: This parameter is not supported by Dialogic® HMP Software.

Description: The **Derive NETREF Two From (User Defined)** parameter specifies the network interface that determines the clocking for the NETREF_2 line. The indicated interface is on the FRU designated by the NETREF Two FRU parameter.

Values:

- Default [default]: The value of this parameter is to be determined by the system software. Its current value is indicated by the Resolved Equivalent.
- NetworkInterfaceOne: NETREF_2 is derived from interface 1 on the FRU designated by the **NETREF Two FRU** parameter.
- NetworkInterfaceTwo: NETREF_2 is derived from interface 2 on the FRU designated by the **NETREF Two FRU** parameter.
- NetworkInterfaceThree: NETREF_2 is derived from interface 3 on the FRU designated by the **NETREF Two FRU** parameter.
- NetworkInterfaceFour: NETREF_2 is derived from interface 4 on the FRU designated by the **NETREF Two FRU** parameter.

NETREF Two Clock Rate (User Defined)

Note: This parameter is not supported by Dialogic® HMP Software.

Description: The **NETREF Two Clock Rate (User Defined)** parameter determines the clock rate for the NETREF_2 line.

Values:

- Default [default]: The value of this parameter is to be determined by the system software. Its current value is indicated by the Resolved Equivalent.
- 8KHz
- 1.536MHz
- 1.544MHz
- 2.048MHz

6.8 Trunk Configuration Property Sheet

The Trunk Configuration property sheet contains parameters for configuring the interfaces on Dialogic® HMP Interface Boards. Each parameter is in the format Trunk x , where x denotes the trunk number (1 to 8).

- [MediaLoad](#)
- [Trunk1](#)
- [Trunk2](#)
- [Trunk3](#)
- [Trunk4](#)
- [Trunk5](#)
- [Trunk6](#)
- [Trunk7](#)
- [Trunk8](#)

MediaLoad

Description: A media load is a pre-defined set of features supported by certain configuration files.

Values:

- NETWORKONLY: This media load is used by various DNI Boards, as listed in [Section 3.3, “Media Loads”](#), on page 22.
- HMPL1: This media load is used by the Dialogic® DNI/601TEPHMP board, as listed in [Section 3.3, “Media Loads”](#), on page 22.

Trunk1

Description: The **Trunk1** parameter specifies the protocol and line type to use on the interface associated with trunk 1 of the board.

Values:

Group 1 Protocol Values:

- 4ESS (T1)
- 5ESS (T1)
- NTT(T1)
- NI2 (T1)
- DMS (T1)
- QSIGT1 (T1)
- QSIGE1 (E1)
- NET5 (E1)
- T1CC (T1)
- CAS (T1)

Dialogic® Configuration Manager (DCM) Parameter Reference

- E1CAS (E1)
- E1CC (E1)
- R2MF (E1) (supported on Dialogic® DNI/601TEPHMP boards only)

Group 2 Protocol Values:

- DPNSS (E1)
- DASS2 (E1)

Guidelines: Depending on the board, you may assign the same protocol or different protocols to each trunk on the board, but all of the protocols must belong to the same group. The R2MF protocol is supported on the DNI/601TEPHMP board only.

For the DNI/300TEPHMP, DNI/1200TEPHMP, DNI/310TEPEHMP, DNI/610TEPEHMP, DNI/1210TEPEHMP, and DNI/2410TEPEHMP boards, you may assign any protocol except for R2MF to a trunk.

For the DNI/610TEPEHMP and DNI/1210TEPEHMP boards, all of the protocols assigned must belong to the same group (Group 1 or Group 2) and have the same line type (T1 or E1).

For the DNI/2410TEPEHMP board, all of the protocols on trunks 1-4 must belong to the same group (Group 1 or Group 2) and have the same line type (T1 or E1), and all of the protocols on trunks 5-8 must belong to the same group and have the same line type.

Trunk2

Description: The **Trunk2** parameter specifies the protocol and line type to use on the interface associated with trunk 2 of the board, if available.

Values: See the values listed for “[Trunk1](#)”, on page 79.

Guidelines: See the guidelines for “[Trunk1](#)”, on page 79.

Trunk3

Description: The **Trunk3** parameter specifies the protocol and line type to use on the interface associated with trunk 3 of the board, if available.

Values: See the values listed for “[Trunk1](#)”, on page 79.

Guidelines: See the guidelines for “[Trunk1](#)”, on page 79.

Trunk4

Description: The **Trunk4** parameter specifies the protocol and line type to use on the interface associated with trunk 4 of the board, if available.

Values: See the values listed for “[Trunk1](#)”, on page 79.

Guidelines: See the guidelines for “[Trunk1](#)”, on page 79.

Trunk5

Description: The **Trunk5** parameter specifies the protocol and line type to use on the interface associated with trunk 5 of the board, if available.

Values: See the values listed for “[Trunk1](#)”, on page 79.

Guidelines: See the guidelines for “[Trunk1](#)”, on page 79.

Trunk6

Description: The **Trunk6** parameter specifies the protocol and line type to use on the interface associated with trunk 6 of the board, if available.

Values: See the values listed for “[Trunk1](#)”, on page 79.

Guidelines: See the guidelines for “[Trunk1](#)”, on page 79.

Trunk7

Description: The **Trunk7** parameter specifies the protocol and line type to use on the interface associated with trunk 7 of the board, if available.

Values: See the values listed for “[Trunk1](#)”, on page 79.

Guidelines: See the guidelines for “[Trunk1](#)”, on page 79.

Trunk8

Description: The **Trunk8** parameter specifies the protocol and line type to use on the interface associated with trunk 8 of the board, if available.

Values: See the values listed for “[Trunk1](#)”, on page 79.

Guidelines: See the guidelines for “[Trunk1](#)”, on page 79.

6.9 Version (Version Info.) Property Sheet

The Version (Version Info.) property sheet contains parameters that identify kernel versions and include the following:

- [CPBKVersion](#)
- [CPRTKVersion](#)
- [SPBKVersion](#)
- [SPRTKVersion](#)

CPBKVersion

Description: The **CPBKVersion** parameter indicates the control processor boot kernel version.

Values: Version number set by the system software.

Guidelines: The **CPBKVersion** parameter should not be modified by the user.

CPRTKVersion

Description: The **CPRTKVersion** parameter indicates the control processor runtime kernel version.

Values: Version number set by the system software.

Guidelines: The **CPRTKVersion** parameter should not be modified by the user.

SPBKVersion

Description: The **SPBKVersion** parameter indicates the signal processor boot kernel version.

Values: Version number set by the system software.

Guidelines: The **SPBKVersion** parameter should not be modified by the user.

SPRTKVersion

Description: The **SPRTKVersion** parameter indicates the signal processor runtime kernel version.

Values: Version number set by the system software.

Guidelines: The **SPRTKVersion** parameter should not be modified by the user.

This chapter provides background information about CONFIG (*.config*) files including directory location and formatting conventions. This chapter also includes information to help you set the parameters contained in the CONFIG file.

- CONFIG File Formatting Conventions 83
- CONFIG File Sections 84
- [Encoder] Section 85
- [NFAS] Section 86
- [CHP] Section 87
- [TSC] Section 88

7.1 CONFIG File Formatting Conventions

The CONFIG (*.config*) files, located in the *data* directory under INTEL_DIALOGIC_DIR (the environment variable for the directory in which the software is installed), are ASCII files that contain component configuration information required by Dialogic® boards. When manually editing the CONFIG file, use the following formatting conventions:

Parameters

Many CONFIG file parameters use the SetParm command to assign values. The format is SetParm followed by an equal sign, followed by the hexadecimal parameter number, followed by a comma, followed by the parameter value:

```
SetParm=parameter-number, parameter-value
```

Additional commands used to set parameters include:

- AddNFASInterface (see “GroupID (Group Identifier)”, on page 115)
- Variant (see Section 7.5, “[CHP] Section”, on page 87)
- defineBSet (see Section 7.6, “[TSC] Section”, on page 88).

Sections

Configuration parameters are grouped into sections. In general, each section begins with a section name enclosed in square brackets. (The section names are listed and described in Section 7.2, “CONFIG File Sections”, on page 84.) The parameters for the section immediately follow the section name.

```
[section-name]
```

Some sections group parameters that apply to a specific network interface (trunk) or channel (line). These section names are followed by a period (.) and the trunk number. For sections that group parameters like this, there is a separate section for each trunk.

```
[section-name.trunk-number]
```

CONFIG File Details

Comments

Comments can be added to the CONFIG file. If you use an exclamation point (!) anywhere on a line, all text to the right of the exclamation point until the end of the line is treated as a comment (ignored).

```
! comment
```

For a list of CONFIG file parameters, see [Chapter 8, “CONFIG File Parameter Reference for Dialogic® HMP Software”](#) and [Chapter 9, “CONFIG File Parameter Reference for Dialogic® HMP Interface Boards”](#).

7.2 CONFIG File Sections

CONFIG file parameters are grouped in sections based on the board components and subcomponents being configured. Modifiable CONFIG file sections include the following:

Note: If you use T1, E1CAS, and R2MF protocols in a system with DNI Boards, you can configure these protocols using Protocol Development Kit (PDK) parameters. For more information, see the *Dialogic® Global Call Country Dependent Parameters (CDP) for PDK Protocols Configuration Guide*.

[0x2c]

Defines parameters used to set the tail length, or tap length, of the enhanced echo canceller.

[encoder]

Defines parameters used during the encoding process that utilize the Automatic Gain Control (AGC) and Silence Compressed Record (SCR) algorithms. For details about setting algorithm parameters, see [Section 7.3, “\[Encoder\] Section”](#), on page 85.

[lineAdmin.x]

Defines line device parameters applicable to each trunk on a board that has T1 or E1 trunks.

[NFAS] and [NFAS.x]

Non-Facility Associated Signaling (NFAS). Defines the Primary D channel and NFAS trunk parameters. The [NFAS] section defines the number of NFAS groups on a board. The [NFAS.x] sections define the parameters specific to each group. For details about setting the NFAS parameters, see [Section 7.4, “\[NFAS\] Section”](#), on page 86.

[CCS] and [CCS.x]

Common Channel Signaling (CCS). Defines common channel signaling parameters applicable to technologies such as ISDN. The [CCS] section defines board-based parameters and the [CCS.x] section defines the line-based parameters.

[CHP]

Channel Protocol (CHP). Defines the telephony communication protocol that is used on each network interface using the Variant Define *n* command. For details about setting [CHP] parameters using the Variant Define *n* command, see [Section 7.5, “\[CHP\] Section”](#), on page 87.

[TSC]

Telephony Service Component (TSC). Defines sets of B channels and associated characteristics using the defineBSet command. For details about setting [TSC] parameters using the defineBSet command, see [Section 7.6, “\[TSC\] Section”](#), on page 88.

7.3 [Encoder] Section

The encoder parameters are used to perform an encoding process on a media stream. Automatic Gain Control (AGC) and Silence Compressed Record (SCR) are two algorithms used as part of this encoding process.

The AGC is an algorithm for normalizing an input signal to a target record level. The target record level should be chosen to be the optimum level for an encoder and, at the same time, produce a suitable playback level for a listener.

The AGC algorithm is controlled by three parameters: **PrmAGCk**, **PrmAGCmax_gain**, and **PrmAGClow_threshold**. **PrmAGCk** is a target output level. **PrmAGCmax_gain** is the limit on the possible maximum gain. The ratio, $\text{PrmAGCk}/\text{PrmAGCmax_gain}$ gives the AGC High Threshold value. This is the threshold for which inputs above it produce output level at the **PrmAGCk** level and inputs with a level below it produce outputs which linearly decrease with the input level. The **PrmAGClow_threshold**, on the other hand, is an upper limit for a noise level estimate. That is, a signal with a level above the **PrmAGClow_threshold** is declared speech, independently of whether it is or not. Below the threshold, the AGC algorithm itself tries to discriminate between voiced and unvoiced signals.

Figure 18 is a graphical representation of the AGC gain relative to input average.

Figure 18. AGC Gain vs. Input Average

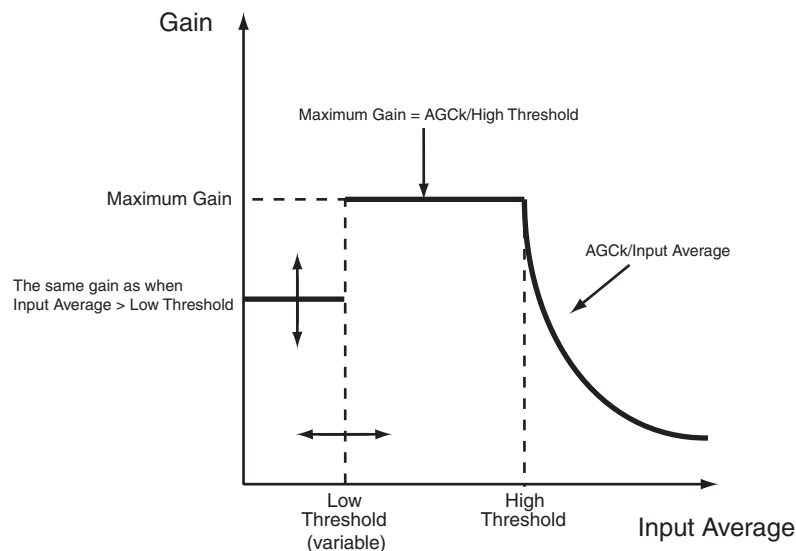

The SCR algorithm operates on 1 millisecond blocks of speech and uses a twofold approach to determine whether a sample is speech or silence. Two Probability of Speech values are calculated using a Zero Crossing algorithm and an Energy Detection algorithm. These values are combined to calculate a Combined Probability of Speech.

CONFIG File Details

The Zero Crossing algorithm counts the number of times a sample block crosses a zero line, thus establishing a rough “average frequency” for the sample. If the count for the sample falls within a predetermined range, the sample is considered speech.

The Energy Detection algorithm allows user input at the component level of a background noise threshold range via the **AEnc_VADHiThr** and **AEnc_VADLoThr** parameters. Signals above the high threshold are declared speech and signals below the low threshold are declared silence.

SCR declares speech or silence for the current 1 millisecond sample based on the following:

- Previous 1 millisecond sample declaration (speech or silence)
- Combined Probability of Speech in relation to the Speech Probability Threshold (**AEnc_VADSpchPrO**)
- Combined Probability of Speech in relation to the Silence Probability Threshold (**AEnc_VADSpchPrC**)
- Trailing Silence (**AEnc_VADSpchHng**) relative to Silence Duration

The logic is as follows:

Previous sample = Silence

```
If Combined Probability of Speech > Speech Probability Threshold
  then Declare Speech
  else Declare Silence
```

Previous sample = Speech

```
If Combined Probability of Speech > Silence Probability Threshold
  then Declare Speech
  else If Silence Duration < Trailing Silence
    then Declare Speech
    else Declare Silence
```

7.4 [NFAS] Section

Non-Facility-Associated Signaling (NFAS) uses a single ISDN PRI D channel to provide signaling and control for up to 10 ISDN PRI lines. Normally, on an ISDN PRI line, one D channel is used for signaling and 23 B channels (bearer channels) are used for transferring information. In an NFAS configuration, therefore, one D channel can support the signaling and control for up to 239 B channels. The trunk that provides the signaling is called the primary D channel. The trunks that use all 24 channels as B channels are called NFAS trunks.

Note the following:

- For a board containing multiple primary D channels, the maximum number of trunks supported by each NFAS group on that board is reduced. This is due to the additional message load on the board’s CPU.
- NFAS is supported on ISDN NI-2, 4ESS, 5ESS, and DMS protocols.

- NFAS D channel backup (DCBU) is supported on ISDN 4ESS, 5ESS, NI-2 protocol.
- When NFAS is used, the **SignalingType** parameter in the [lineAdmin] section of the CONFIG file must be modified. For details about this parameter modification, see [Section 9.2, “\[lineAdmin.x\] Parameters”](#), on page 105.

The CONFIG file contains an [NFAS] section and multiple [NFAS.x] sections. The [NFAS] section defines the number of NFAS instances created, that is, defines the number of NFAS groups. For each NFAS group, there is an [NFAS.x] section in the CONFIG file. For example, if there are two NFAS groups defined in the [NFAS] section, there will be two [NFAS.x] sections, [NFAS.1] and [NFAS.2].

NFAS parameters are modified by editing the respective lines in the [NFAS] and [NFAS.x] sections of the CONFIG file. For example, to increase the number of NFAS groups per board from one to four, change the value of **NFAS_INSTANCE_MAP** (parameter = 0x3E02) from a value of 1 (one group per board) to a binary value of 1111 (four NFAS groups per board) represented by 0xF.

Following is an excerpt from the [NFAS] section of a CONFIG file that illustrates that part of the file before and after editing.

Before editing:

```
[NFAS]
SetParm=0x3e02,0x1 !INSTANCE MAP, default = 1 (1 group/board)
```

After editing:

```
[NFAS]
SetParm=0x3e02,0xf !INSTANCE MAP - 4 NFAS groups/board
```

7.5 [CHP] Section

The Channel Protocol (CHP) component implements the telephony communication protocol that is used on each network interface. There are different versions of this component for handling different signaling types as well as different protocol types on different B channels. There is one CHP instance created for each B channel in the system.

The [CHP] section of the CONFIG file is a subset of the [TSC] section. Protocol-specific parameters, primarily in the form of variants, are defined in the [CHP] section. The selection of which of these protocol variants to use on which line (span) is determined in the [TSC] section. For more information on protocol variants selection, see [Section 7.6, “\[TSC\] Section”](#), on page 88.

A number of protocol variants are defined in the [CHP] section of the CONFIG file. Variants are defined by the Variant Define *n* command, where *n* is the variant identifier. The Variant Define *n* command defines variant “*n*” as all of the parameter definitions in the [CHP] section preceding the command.

Note: If a parameter is defined multiple times prior to the Variant Define *n* command, then only the last definition of the parameter is used for that variant.

CONFIG File Details

[CHP] T1 Protocol variants are configured using Protocol Development Kit (PDK) parameters. For more information, see the *Dialogic® Global Call Country Dependent Parameters (CDP) for PDK Protocols Configuration Guide*.

Although protocol variants are defined in the [CHP] section, protocol variants are assigned in the [TSC] section of the CONFIG file. Selecting a particular Variant Define n is accomplished by changing the values of the **Inbound** and **Outbound** parameters for a particular line. The **Inbound** and **Outbound** parameters are the sixth and seventh parameters respectively in the defineBSet command in the [TSC] section of the CONFIG file.

For information about the defineBSet command and setting TSC parameters, see [Section 7.6, “\[TSC\] Section”](#), on page 88.

For information about each CHP parameter, see the following sections:

- [Section 9.6, “\[CHP\] Parameters”](#), on page 121
- [Section 9.7, “\[CHP\] ISDN Protocol Variant Definitions”](#), on page 122

7.6 [TSC] Section

The [TSC] section of the CONFIG file defines a set of B channels and associated characteristics using the defineBSet command. The syntax of the defineBSet command is:

```
defineBSet = SetId, LineId, StartChan, NumChans, BaseProtocol, Inbound, OutBound, DChanDesc, Admin, Width, BChanId, SlotId, Direction, Count, [BChanId, SlotId, Direction, Count,] 0
```

To change a [TSC] parameter, you change the value of the applicable defineBSet parameter in the CONFIG file. For example, to change the protocol variant from 2 to 4 for both inbound and outbound call processing on all 30 channels of line 2, you would change the value of the **Inbound** and **Outbound** parameters for line 2 (**SetId=20**) from 2 to 4. For information on defining protocol variants, see [Section 7.5, “\[CHP\] Section”](#), on page 87.

Following is an excerpt from the [TSC] section of a CONFIG file that illustrates that part of the file before and after editing.

Before editing:

```
defineBSet=10,1,1,30, 0,1,1,1,20,1, 1,1,3,15, 16,17,3,15,0  
defineBSet=20,2,1,30, 0,2,2,1,20,1, 1,1,3,15, 16,17,3,15,0
```

After editing:

```
defineBSet=10,1,1,30, 0,1,1,1,20,1, 1,1,3,15, 16,17,3,15,0  
defineBSet=20,2,1,30, 0,4,4,1,20,1, 1,1,3,15, 16,17,3,15,0
```

For information about each TSC parameter, see [Section 9.9, “\[TSC\] defineBSet Parameters”](#), on page 130.

CONFIG File Parameter Reference for Dialogic® HMP Software

8

This chapter lists and describes parameters contained in the CONFIG file for Dialogic® Host Media Processing (HMP) Software. Parameters are grouped according to the CONFIG file sections.

- [0x2c] Echo Cancellation Parameters 89
- [encoder] Parameters 91
- [0x3b] Conferencing Parameters 94
- [IPVSC] IP Media Parameters 97
- [decoder] Speed Control Parameter 101
- [sigDet] Parameters 101

Note: Not all parameters are included in each CONFIG file, as this depends on the license purchased. CONFIG file parameters that **should not be modified** by the user are omitted from this document.

Note: Modified CONFIG file parameters can be preserved and re-applied whenever a Dialogic® HMP Software license is changed or re-activated by using the user configuration file, *Hmp.Uconfig*. For more information, see [Section 4.9, “Preserving Data in User Configuration Files”](#), on page 39.

8.1 [0x2c] Echo Cancellation Parameters

The [0x2c] section of the CONFIG file includes the following parameters used to adjust echo cancellation settings for specific devices in Dialogic® HMP Software:

- [EC Enablement](#)
- [EC Filter Length](#)
- [Echo Canceller NLP](#)

EC Enablement

Number: 0x2c00

Description: The **EC Enablement** parameter allows control of the echo canceller used in conferencing, continuous speech processing (CSP) and other applications requiring echo cancellation.

Values:

- 0x0: EC disabled
- 0x1 [default]: EC enabled

Guidelines: This parameter is not included in the configuration file. To modify the parameter value, you must add this parameter manually in the configuration file in the [0x2c] section.

The **EC Enablement** parameter can be set in the CONFIG file for Dialogic® HMP Software or for certain DNI Boards that have an echo canceller on the board itself. When set in the CONFIG file for the board, it affects EC on the DTI device of the board only. When set in the CONFIG file for the Dialogic® HMP Software, it affects EC for the conferencing and CSP devices. For more information on configuring echo cancellation features, see [Section 5.4, “Configuring Host-Based Echo Cancellation”](#), on page 45. For more information about setting EC on DNI Boards, see [Section 9.1, “\[0x2c\] Echo Cancellation Parameters”](#), on page 104.

EC Filter Length

Number: 0x2c03

Description: The **EC Filter Length** parameter specifies the tail length, or tap length, of the enhanced echo canceller used by a conferencing device and by a continuous speech processing (CSP) device.

Note: The CSP API library provides a parameter, through `ec_setparm()`, for setting the tap length. The audio conferencing (DCB) API library does not. When available, the API library method is preferable for setting parameters. Be aware that setting the tap length using this CONFIG file parameter affects both the conferencing device and the CSP device. For more information on configuring echo cancellation features, see [Section 5.4, “Configuring Host-Based Echo Cancellation”](#), on page 45.

Values:

- 64: 8 ms
- 80: 10 ms
- 128 [default]: 16 ms
- 192: 24 ms
- 256: 32 ms
- 512: 64 ms

Guidelines: When determining the tail length value, consider the length of the echo path delay your system will encounter as well as your overall system configuration. Longer tail lengths are provided to handle echo with longer path delays. To achieve better performance (that is, faster convergence and less noise), use the shortest tail length setting that is consistent with the expected echo path delay. The tail length setting should be at least as long as the expected echo path delay, if not longer.

Echo Canceller NLP

Number: 0x2c01

Description: The **Echo Canceller NLP** parameter specifies whether non-linear processing (NLP) is enabled or not for all conferencing devices and for all continuous speech processing (CSP) devices.

Note: The CSP API library also provides a parameter, through **ec_setparm()**, for setting NLP. The audio conferencing (DCB) API library does not. When available, the API library method is preferable for setting parameters. Be aware that setting the NLP using this CONFIG file parameter affects both the conferencing device and the CSP device. For more information on configuring echo cancellation features, see [Section 5.4, “Configuring Host-Based Echo Cancellation”](#), on page 45.

Values:

- 0x0: NLP disabled
- 0x1 [default]: NLP enabled

Guidelines: The **Echo Canceller NLP** parameter must be turned off for automatic speech recognition applications. This parameter is not included in the configuration file. To modify the parameter value, you must add this parameter manually in the configuration file in the [0x2c] section.

8.2 [encoder] Parameters

The [encoder] section of the CONFIG file can include the following parameters:

- [AEnc_VADHiThr](#) (SCR High Background Noise Threshold)
- [AEnc_VADLoThr](#) (SCR Low Background Noise Threshold)
- [AEnc_VADSpchHng](#) (SCR Trailing Silence)
- [AEnc_VADSpchPrC](#) (SCR Silence Probability Threshold)
- [AEnc_VADSpchPrO](#) (SCR Speech Probability Threshold)
- [RM_ISCR](#) (VAD Silence Compression)

AEnc_VADHiThr (SCR High Background Noise Threshold)

Number: 0x41A

Description: The **AEnc_VADHiThr** parameter is used for Silence Compressed Recording and controls the high threshold for background noise estimation and, along with **AEnc_VADLoThr** parameter, forms a range of loudness. Any signal above this threshold is declared speech.

Reducing this threshold increases the probability of recording noise and decreases the probability of losing speech.

AEnc_VADHiThr is defined as: $10(\text{dB value}/20) * 2^{23}$. Multiplying by 2^{23} converts the value into a linear 24-bit value.

For example, for a high noise threshold of -20 dB, **AEnc_VADHiThr** would have a value of: $10(-20/20) * 2^{23} = 838860$.

Values:

- 83887 to $2^{23}+$ (-40 dB to 0 dB)
- 838860 (0xccccc) [default]

Guidelines: This parameter is not included in the configuration file. To modify the parameter value, you must add this parameter manually in the [encoder] section.

AEnc_VADLoThr (SCR Low Background Noise Threshold)

Number: 0x419

Description: The **AEnc_VADLoThr** parameter is used for Silence Compressed Recording and controls the low threshold for background noise estimation and, along with **AEnc_VADHiThr** parameter, forms a range of loudness. Any signal below this threshold is declared silence. Increasing this threshold increases the probability of losing speech and decreases the probability of recording noise.

AEnc_VADLoThr is defined as: $10(\text{dB value}/20) * 2^{23}$. Multiplying by 2^{23} converts the value into a linear 24-bit value.

For example, for a low noise threshold of -78 dB, **AEnc_VADLoThr** would have a value of: $10(-78/20) * 2^{23} = 1056$.

Values:

- 839 to 83887 (-80 dB to -40 dB)
- 1056 (0x420) [default]

Guidelines: This parameter is not included in the configuration file. To modify the parameter value, you must add this parameter manually in the [encoder] section.

AEnc_VADSpchHng (SCR Trailing Silence)

Number: 0x415

Description: The **AEnc_VADSpchHng** parameter is used for Silence Compressed Recording and defines the duration of silence allowed following speech before SCR begins (trailing silence).

Values: 100 to 1000 (milliseconds)

Guidelines: If it is set too low, words and sentences will run together; if it is set too high, SCR efficiency will be reduced, resulting in larger files.

AEnc_VADSpchPrC (SCR Silence Probability Threshold)

Number: 0x418

Description: The **AEnc_VADSpchPrC** parameter is used for Silence Compressed Recording and sets the threshold that the calculated probability of speech value is compared to in declaring silence. If the probability of speech is less than this parameter, silence is declared.

The **AEnc_VADSpchPrC** parameter primarily affects the sensitivity of detecting silence at the trailing time of a speech period versus false silence detection.

AEnc_VADSpchPrC is defined as: (Probability Value) * 2^{23} . Multiplying by 2^{23} converts the value into a linear 24-bit value.

For example, for a silence probability threshold of 0.39, **AEnc_VADSpchPrC** would have a value of: $0.39 * 2^{23} = 3271557$.

Values:

- 0 to 4194304 (0.0 to 0.50 probability)
- 3271557 (0x31eb85) [default]

Guidelines: This parameter is not included in the configuration file. To modify the parameter value, you must add this parameter manually in the [encoder] section.

AEnc_VADSpchPrO (SCR Speech Probability Threshold)

Number: 0x417

Description: The **AEnc_VADSpchPrO** parameter is used for Silence Compressed Recording and sets the threshold that the calculated probability of speech value is compared to in declaring speech. If the probability of speech is greater than this parameter, speech is declared.

The **AEnc_VADSpchPrO** parameter primarily affects the sensitivity of detecting speech at the leading time of a speech period versus false speech detection.

AEnc_VADSpchPrO is defined as: (Probability Value) * 2^{23} . Multiplying by 2^{23} converts the value into a linear 24-bit value.

For example, for a speech probability threshold of 0.58, **AEnc_VADSpchPrO** would have a value of: $0.58 * 2^{23} = 4865392$.

Values:

- 4194304 to 2^{23} (0.50 to 1.00 probability)
- 4865392 (0x4a3d70) [default]

Guidelines: This parameter is not included in the configuration file. To modify the parameter value, you must add this parameter manually in the [encoder] section.

RM_ISCR (VAD Silence Compression)

Number: 0x416

Description: The **dx_reciottdata()** function, used to record voice data, has two modes:

- **RM_VADNOTIFY** - generates a TDX_VAD event on detection of VAD during the recording operation.

CONFIG File Parameter Reference for Dialogic® HMP Software

- RM_ISCR - adds initial silence compression to the VAD detection capability.

Note: The RM_ISCR mode can only be used in conjunction with RM_VADNOTIFY.

Guidelines: The **RM_ISCR** parameter is used to add initial silence compression to the VAD capability. Initial silence refers to the amount of silence on the line *before* voice activity is detected. When using RM_ISCR, the default value for the amount of initial silence allowable is 3 seconds. Any initial silence longer than that is truncated (eliminated) to the default allowable amount. This default value can be changed, however, by adding the RM_ISCR parameter to the [encoder] section of the CONFIG file.

For example, to change the default value for the amount of allowable silence to 6 seconds when using RM_ISCR, you would add the following to the [encoder] section:

```
SetParm=0x416, 6
```

For more information about the **dx_reciottdata()** function and the VAD feature, see the *Dialogic® Voice API Library Reference* and the *Dialogic® Voice API Programming Guide*.

8.3 [0x3b] Conferencing Parameters

The [0x3b] section of the CONFIG file includes the following parameters associated with the conferencing device in Dialogic® HMP Software:

- [Comfort Noise Generation in Conferencing](#)
- [CSUMS_AGC_low_threshold \(Conferencing AGC Noise Level Threshold\)](#)
- [NotifyAddToneLevel](#)
- [NotifyAddToneFreq](#)
- [NotifyAddToneLength](#)

Comfort Noise Generation in Conferencing

Number: 0x3b38

Description: Comfort noise generation can be generated on the outputs of a conference whenever the conference output drops below the no-talker level across the board. The comfort noise generation parameter is used to enable or disable comfort noise generation (CNG).

Values:

- 0 [default]: comfort noise generation disabled
- 1: comfort noise generation enabled

Guidelines: It is recommended that you accept the default values for setting the silence threshold, noise amplitude, and hang time parameters. If it is necessary to modify these values,

you must manually add the parameters to the CONFIG file in the [0x3b] section. The parameters are:

```
SetParm=0x3b39,100 ! Silence threshold, default is 100 (-43dbm), 1630  
(-18.5dbm) is maximum
```

```
SetParm=0x3b3a,200 ! Noise amplitude, default is 200 (-43dbm), 3270  
(-18.5dbm) is maximum
```

```
SetParm=0x3b3b,25 ! Hang time, default is 25 (25 gives 12msx25=300ms,  
but actually results in 620 ms due to exponential averaging)
```

CSUMS_AGC_low_threshold (Conferencing AGC Noise Level Threshold)

Number: 0x3b1f

Description: The **CSUMS_AGC_low_threshold** parameter defines the upper threshold for noise level estimates. Any signal above this threshold is considered speech. Thus, this threshold should be set quite high in order to let the AGC algorithm determine when there are voiced and unvoiced periods. The parameter is given in terms of the average level.

CSUMS_AGC_low_threshold is defined as: $10(\text{outputlevel in dB})/20 * 2^{23}$. Multiplying by 2^{23} converts the value into a linear 24-bit value that accommodates the 24-bit DSPs used on the DM3 boards.

Values: 0x0020c5 to 0x0732ae (-60 dB_{avg} to -25 dB_{avg}).
The default value is 0x0147ae (-40 dB_{avg}).

Guidelines: The default value of -40 dB is the best setting for most applications. To modify the parameter value, you must add this parameter manually in the configuration file in the [0x3b] section.

The following example sets the AGC noise level to a value of -50 dB_{avg}:

```
SetParm=0x3b1f,0x00679f
```

The calculation to get the hexadecimal value for an AGC noise threshold level of -50 dB_{avg} is:

$$10(-50/20) * 2^{23} = 0x00679f$$

It is recommended that the value be set in the range of -60 dB to -40 dB. Do not exceed the AGC high level threshold which is set to -34.6 dB in the current DM3 system.

NotifyAddToneLevel

Number: 0x3b24

Description: The **NotifyAddToneLevel** parameter specifies the amplitude of the conference notification tone.

Values:

- 1673747 [default]: this is equivalent to -14dB
- User-specified range: This field accepts any value, and it is the responsibility of the user application to ensure that the values are within an acceptable range for the market environment for which it is deployed.

Guidelines: The format of the parameter value in the CONFIG file represents the equivalent natural number of the target decibel. For example, when setting the value of the amplitude to -14dB, the entry in the file would be:

```
SetParm= 0x3b24, 1673747
```

The conversion formula used is as follows:

Natural number = $10\text{dB}/20 * 223$

where dB is the desired decibel and 223 is a normalization factor.

NotifyAddToneFreq

Number: 0x3b25

Description: The NotifyAddToneFreq parameter specifies the frequency of the conference notification tone (in 1 Hz units).

Values: 50 to 3500 Hz

Default: 975 Hz

Guidelines: The format of the parameter value in the CONFIG file should be entered in units of 1 Hz. For example, to specify a 110 Hz frequency, the entry would be:

```
SetParm= 0x3b25, 110
```

If the value entered is outside the valid range, the default is set.

NotifyAddToneLength

Number: 0x3b26

Description: The NotifyAddToneLength parameter specifies the length of the conference notification tone (in 10 ms units).

Values:

- 30 ms:
- User-specified range: The user-specified range field accepts any value, and it is the responsibility of the user application to ensure that the values are within an acceptable range for the market environment for which it is deployed.

Guidelines: The format of the parameter value in the CONFIG file should be entered in units of 10 ms. For example, to specify a 50 ms length, the entry would be:

```
SetParm= 0x3b26, 5
```

Note: The conference tone definition applies to all conferences. To avoid tone conflicts between conferences, only a single tone specification is applicable for all active conferences.

Note: Enabling and disabling the conference notification tone behaves in the same way as currently supported when a conference is established. That is, notification is either ON or OFF. It is applicable to both conference party addition and removal. For example, this feature does not support enabling party addition (entry) while disabling party removal (exit) notification. The conference notification setting for both operations is either enabled (ON) or disabled (OFF).

8.4 [IPVSC] IP Media Parameters

The [IPVSC] section of the CONFIG file includes the following parameters associated with the IP media device in Dialogic® HMP Software:

- [UDP Port Base for Audio RTP](#)
- [UDP Port Base for Video RTP](#)
- [EC Enablement](#)
- [EC Tail Length](#)
- [PrmPlr_LatencyAlg_Audio \(Latency Mode\)](#)
- [PrmRxLatencyFrameInit_Audio \(PLR Initial Latency\)](#)
- [PrmRxLatencyFrameMax_Audio \(PLR Maximum Latency\)](#)
- [Receive-only RFC 2833 Mode](#)
- [RTP Source Filter](#)

UDP Port Base for Audio RTP

Number: 0x4005

Description: This parameter specifies the UDP port base for audio RTP. Two ports (1 RTP, 1 RTCP) are used for each instance of an IP media device. The default value for the base port is 49152. For example, in a configuration with 400 instances of IP media devices, the range of values would be 49152 to 49951. RTP and RTCP use paired ports; the even one is for RTP and the odd one is for RTCP. The first instance used would get 49152 for RTP and 49153 for RTCP. This parameter allows you to set the range used by Dialogic® HMP Software in order to avoid conflicts with other entities that use UDP ports.

Values: 0 to 0xffff. Default value for base port is 49152.

Guidelines: Although the range of values is 0 to 0xffff, the UDP standard may specify a more restricted range. Additionally, the range of values varies depending on the number of instances of IP media devices being used.

UDP Port Base for Video RTP

Number: 0x4006

Description: This parameter specifies the UDP port base for video RTP. Two ports (1 RTP, 1 RTCP) are used for each instance of an IP media device. The default value for the base port is 57344. For example, in a configuration with 400 instances of IP media devices, the range of values would be 57344 to 58143. RTP and RTCP use paired ports; the even one is for RTP and the odd one is for RTCP. The first instance used would get 57344 for RTP and 57345 for RTCP. This parameter allows you to set the range used by Dialogic® HMP Software in order to avoid conflicts with other entities that use UDP ports.

Values: 0 to 0xffff. Default value for base port is 57344.

Guidelines: Although the range of values is 0 to 0xffff, the UDP standard may specify a more restricted range. Additionally, the range of values varies depending on the number of instances of IP media devices being used.

EC Enablement

Number: 0x1b12

Description: The **EC Enablement** parameter specifies whether echo cancellation is enabled or not in Dialogic® HMP Software.

Values:

- 0 [default]: echo cancellation disabled
- 1: echo cancellation enabled

Guidelines: Use the **ipm_SetParm()** function to turn on echo cancellation on a per-channel basis. See [Section 5.4.1, “Echo Cancellation on IP Media Devices”](#), on page 45 for more information.

EC Tail Length

Number: 0x1b13

Description: The **EC Tail Length** parameter specifies the tail length of the echo canceller in Dialogic® HMP Software.

Values:

- 128 [default]: 16 ms
- 512: 64 ms

Guidelines: Use the **ipm_SetParm()** function to modify the echo canceller tail length on a per-channel basis. See [Section 5.4.1, “Echo Cancellation on IP Media Devices”](#), on page 45 for more information.

PrmPlr_LatencyAlg_Audio (Latency Mode)

Number: 0x1b95

Description: This parameter defines the mode of operation for the jitter buffer. By default, the jitter buffer uses the adaptive mode, which means latency can grow until the available number of frames (defined by the **PrmRxLatencyFrameMax_Audio** parameter) is depleted. Using the fixed mode, the number of frames buffered can grow up to 2 times the starting value (defined by the **PrmRxLatencyFrameInit_Audio** parameter).

Values:

- 0 [default]: adaptive mode enabled
- 1: fixed mode enabled

Guidelines: Use the adaptive mode to minimize audio loss due to abnormal packet reception conditions. Use the fixed mode to minimize latency growth by sacrificing audio quality. This parameter is not included in the configuration file. To modify the parameter value, you must add this parameter manually in the configuration file in the [IPVSC] section.

PrmRxLatencyFrameInit_Audio (PLR Initial Latency)

Number: 0x1b07

Description: This parameter specifies the amount of packet loss recovery (PLR) latency (delay) that can be introduced by defining the initial number of frames that can be buffered. This parameter defines the starting value for initial latency.

Note: When the fixed mode is enabled (see **PrmPlr_LatencyAlg_Audio** parameter), the number of frames buffered can grow up to 2 times the starting value. For example, if the parameter value is 6, the maximum number of frames that can be buffered is 12.

The packet loss recovery module attempts to restore packets arriving at the receive end as close as possible to their original time-stamped positions. Arriving packets are decomposed into individual frames, each with a unique time stamp.

Each new frame is then stored in a jitter buffer before being sent to the decoder. This is done to allow packets arriving out of order to be inserted in the queue in the correct order. The size of this jitter buffer is defined by the number of frames stored and is controlled by the **PrmRxLatencyFrameInit_Audio**, **PrmRxLatencyFrameMax_Audio**, and **PrmPlr_LatencyAlg_Audio** parameters.

Values: 1 to **PrmRxLatencyFrameMax_Audio** value (frames). Default value is 6.

Guidelines: This parameter is not included in the configuration file. To modify the parameter value, you must add this parameter manually in the configuration file in the [IPVSC] section.

PrmRxLatencyFrameMax_Audio (PLR Maximum Latency)

Number: 0x1b08

Description: This parameter defines the maximum number of frames to be buffered in the Packet Loss Recovery (PLR) frame list. This parameter adds latency only when the buffer is already

CONFIG File Parameter Reference for Dialogic® HMP Software

filled and additional frames arrive before there is space in the buffer. This provides for bursts of packets to arrive, which would have to be discarded otherwise.

The Packet Loss Recovery module attempts to restore packets arriving at the receive end as close as possible to their original time-stamped positions. Arriving packets are decomposed into individual frames, each with a unique time stamp.

Each new frame is then stored in a jitter buffer before sending it to the decoder. This is done to allow packets arriving out of order to be inserted in the queue in the correct order. The size of this jitter buffer is defined by the number of frames stored and is controlled by the **PrmRxLatencyFrameInit_Audio**, **PrmRxLatencyFrameMax_Audio**, and **PrmPlr_LatencyAlg_Audio** parameters.

Values: 30 to 200 (frames). Default value is 100.

Note: On the Windows® operating system, the upper limit of the value is dependent on channel density and Kernel memory availability.

Guidelines: While the number of frames to be buffered should be set as high as possible for best quality, too high a value will add unnecessary latency to the system. Generally, the number of frames buffered should be the same size or slightly larger than the number of frames per packet.

The coder used and its coder frame slice affects the frames per packet or PLR frames per packet. The coders and their coder frame slices are: G.711 (10 ms frame slice), G.723 (30 ms frame slice), G.729 (10 ms frame slice), G.726 (20 ms frame slice). For example, the G.711 coder with 30 ms frame size uses 1 frame per packet but the PLR module stores this data as three 10 ms frames.

Not all coders are supported in all libraries. For more information on coder support in the Global Call API, see the *Dialogic® Global Call IP Technology Guide*. For more information on coder support in the IP media library (IPML) API, see the *Dialogic® IP Media Library API Programming Guide and Library Reference*.

This parameter is not included in the configuration file. To modify the parameter value, you must add this parameter manually in the configuration file in the [IPVSC] section.

Receive-only RFC 2833 Mode

Number: 0x4019

Description: This parameter specifies whether receive-only RFC 2833 mode is set or not on a board basis.

Values:

- 0: receive-only RFC 2833 mode disabled
- 1: receive-only RFC 2833 mode enabled

Guidelines: This parameter is not included in the configuration file. To modify the parameter value, you must add this parameter manually in the configuration file in the [IPVSC] section. For more information on receive-only RFC 2833 mode, see the *Dialogic® IP Media Library API Programming Guide and Library Reference*.

RTP Source Filter

Number: 0x401e

Description: This parameter specifies the RTP source filter based on the destination IP and port.

Values:

- 0: disable
- 1: enable

Guidelines: This parameter is not included in the configuration file. To modify the parameter value, you must add this parameter manually in the [IPVSC] section. For example:

```
SetParm=0x401e, 1 ! Enable RTP Source Filter
```

8.5 [decoder] Speed Control Parameter

The [decoder] section of the CONFIG file includes the following parameter associated with the voice device in Dialogic® HMP Software:

- [Speed Control Enablement](#)

Speed Control Enablement

Number: 0x31e

Description: The **Speed Control Enablement** parameter specifies whether the speed control feature in the voice API library is enabled or not.

Values:

- 0 [default]: speed control disabled
- 1: speed control enabled

Guidelines: For more information on speed control, see the *Dialogic® Voice API Library Reference* and the *Dialogic® Voice API Programming Guide*.

8.6 [sigDet] Parameters

The signal detector section of the CONFIG file may include qualification templates for positive answering machine detection (PAMD) and positive voice detection (PVD) used in call progress analysis.

A tech note was written to provide instructions for modifying the PAMD and PVD qualification template parameters on Dialogic® DM3 boards to accomplish higher successful PAMD and PVD rates. For further information about these parameters, see the tech note at <http://www.dialogic.com/support/helpweb/dxall/tnotes/legacy/2000/tn030.htm>. Although the tech note was written for Dialogic® System Software Release 5.1.1 Feature Pack 1 for Windows®, the information applies to subsequent releases.

CONFIG File Parameter Reference for Dialogic® HMP Software

The modified parameters have now become the default in the firmware, so it is no longer necessary to tune the PAMD and PVD parameters as explained in the tech note. Operating with these new default values should result in improved accuracy of call progress analysis on Dialogic® DM3 boards. However, although these values are the most commonly used, they may not be suitable for every application environment. If needed, the PAMD and PVD templates are still tunable, as explained in the tech note, to achieve even better results based on the individual application environment.

The default PAMD qualification template ID is 106561 (0x1a041), but other valid PAMD qualification template IDs that can be defined in the CONFIG file are:

- 106564 (0x1a044)
- 106565 (0x1a045)
- 106566 (0x1a046)
- 106567 (0x1a047)

The default PVD qualification template ID is 128193 (0x1f4c1), but other valid PVD qualification template IDs that can be defined in the CONFIG file are:

- 128194 (0x1f4c2)
- 128195 (0x1f4c3)
- 128196 (0x1f4c4)
- 128197 (0x1f4c5)

CONFIG File Parameter Reference 9

for Dialogic® HMP Interface Boards

This chapter lists and describes the parameters contained in the CONFIG files used by Dialogic® HMP Interface Boards (also known as DNI Boards). Parameters are grouped according to the CONFIG file sections.

- [0x2c] Echo Cancellation Parameters 104
- [lineAdmin.x] Parameters 105
- [NFAS] Parameters 113
- [NFAS.x] Parameters 114
- [CCS] Parameters 116
- [CHP] Parameters 121
- [CHP] ISDN Protocol Variant Definitions 122
- [TSC] Parameters 130
- [TSC] defineBSet Parameters 130
- [sigDet] Parameters 137

Note: Not all parameters are included in each CONFIG file, as this depends on the board supported by that particular file. CONFIG file parameters that **should not be modified** by the user are omitted from this document. Exceptions are made for parameters that, although they should not be modified by the user, are needed in understanding a particular set of parameters (for example, the [TSC] `defineBSet Width` parameter). For these exceptions, the parameter description states that the value should not be modified by the user.

Note: Modified CONFIG file parameters can be preserved and re-applied whenever a Dialogic® HMP software license is changed or re-activated by using the user configuration file, *Hmp.Uconfig*. For more information, see [Section 4.9, “Preserving Data in User Configuration Files”](#), on page 39.

Note: CAS and R2MF protocols are configured using Protocol Development Kit (PDK) parameters. For more information, see the *Dialogic® Global Call Country Dependent Parameters (CDP) for PDK Protocols Configuration Guide*.

9.1 [0x2c] Echo Cancellation Parameters

The [0x2c] section of the CONFIG file defines parameters used to set the echo cancellation feature of the enhanced echo canceller for a digital network interface device (DTI device).

EC Tail Length

Number: 0x2c03

Description: The **EC Tail Length** parameter specifies the tail length, or tap length, of the enhanced echo canceller for a digital network interface device (DTI device).

Note: The **EC Tail Length** parameter only applies to DNI Boards that have an echo canceller on the board itself, such as the Dialogic® DNI/601TEPHMP and the DNI/310TEPEHMP boards. See [Table 1, “High-Level Feature Support by Platform”](#), on page 14.

Values:

- 0x80: 16 ms
- 0xC0: 24 ms
- 0x100: 32 ms
- 0x200 [default]: 64 ms

Guidelines: When determining the tail length value, consider the length of the echo path delay your system will encounter as well as your overall system configuration. Longer tail lengths are provided to handle echo with longer path delays. To achieve better performance (that is, faster convergence and less noise), use the shortest tail length setting that is consistent with the expected echo path delay. The tail length setting should be at least as long as the expected echo path delay, if not longer.

EC Enablement

Number: 0x2c00

Description: The **EC Enablement** parameter specifies whether echo cancellation is enabled or not on the board.

Note: The **EC Enablement** parameter only applies to DNI Boards that have an echo canceller on the board itself, such as the Dialogic® DNI/601TEPHMP and the DNI/310TEPEHMP boards. See [Table 1, “High-Level Feature Support by Platform”](#), on page 14. The preferred method for enabling and disabling echo cancellation is to do so on a per call basis in real time using the `gc_SetConfigData()` function. For more information, see [Section 5.6, “Configuring On-Board Echo Cancellation”](#), on page 52.

Values:

- 0x0: Echo cancellation disabled
- 0x1 [default]: Echo cancellation enabled

Guidelines: None

EC NLP

Number: 0x2c01

Description: The **EC NLP** parameter specifies whether non-linear processing (NLP) is enabled or not on the board.

Note: The **EC NLP** parameter only applies to DNI Boards that have an echo canceller on the board itself, such as the Dialogic® DNI/601TEPHMP and the DNI/310TEPEHMP boards. See [Table 1, “High-Level Feature Support by Platform”](#), on page 14. The preferred method for enabling and disabling echo cancellation with NLP is to do so on a per call basis in real time using the **gc_SetConfigData()** function. For more information, see [Section 5.6, “Configuring On-Board Echo Cancellation”](#), on page 52.

Values:

- 0x0: EC NLP disabled
- 0x1 [default]: EC NLP enabled

Guidelines: The EC NLP parameter must be turned off for automatic speech recognition applications.

9.2 [lineAdmin.x] Parameters

For DNI boards, the line administration parameters are associated with an individual T1 or E1 trunk. The parameters defined in the [lineAdmin.x] section are associated with line x. For example, parameters in the [lineAdmin.3] section of the CONFIG file are associated with line 3. Line administration parameters include:

- [LineType \(Line Type\)](#)
- [SignalingType \(Signaling Type\)](#)
- [Coding \(Coding\)](#)
- [ZeroCodeSuppression \(Zero Code Suppression\)](#)
- [FramingAlgorithm \(CRC Checking\)](#)
- [LOSDeclaredTime \(LOS Declared Time\)](#)
- [LOSClearedTime \(LOS Cleared Time\)](#)
- [REDCFADecay \(RED CFA Decay\)](#)
- [REDCFADeclareTime \(RED CFA Declare Time\)](#)
- [REDCFAClearedTime \(RED CFA Cleared Time\)](#)
- [YellowCFADeclareTime \(Yellow CFA Declare Time\)](#)
- [YellowCFAClearTime \(Yellow CFA Clear Time\)](#)
- [RAICRCCFADeclareTime \(RAI CRC CFA Declare Time\)](#)
- [RAICRCCFAClearTime \(RAI CRC CFA Clear Time\)](#)
- [Initial Alarm State](#)
- [BPVS Threshold Range](#)
- [OOF Threshold Range](#)

- [FERR Threshold Range](#)
- [ECS Threshold Range](#)
- [CECS Threshold Range](#)

LineType (Line Type)

Number: 0x1601

Description: The **LineType** parameter defines the physical line type (T1 or E1) and the framing format (for example, D4 or ESF). Framing formats include:

D4 framing (D4)

For T1 lines, in D4 framing, 12 frames of 193 bits each (2,316 bits total) constitute a superframe. This framing format supports AB signaling.

Extended superframe (ESF)

For T1 lines, in ESF framing, 24 frames of 193 bits each (4,632 bits total) constitute an extended superframe. This framing format supports ABCD signaling.

CEPT E1

For E1 lines, uses CEPT E1 framing.

Cyclic redundancy check 4 (CRC-4) multi-frame

For E1 lines, this provides for CRC error detection. In this framing format, E1 lines have an extra framing that can coexist with the standard framing and the time slot 16 signaling framing. This extra framing is used to compute and check CRC-4 on incoming lines, to detect remote CRC-4 alarms, and to notify the remote line of CRC-4 errors. When CRC-4 framing is enabled, all CRC-related statistics will be collected and reported, and the RAI_CRC_CFA alarm will be detected and reported.

Values:

- 0: T1 D4 (dsx1_D4)
- 1: T1 ESF (dsx1_ESF)
- 2: E1 CEPT E1 (dsx1_E1)
- 3: E1 CRC 4 multi-frame (dsx1_E1_CRC)

SignalingType (Signaling Type)

Number: 0x1602

Description: The **SignalingType** parameter defines the signaling type to be used by the T1 or E1 line. Signaling types include:

Channel associated signaling (CAS)

In CAS, the signaling for each channel is directly associated with that channel. T1 robbed-bit signaling is an example of CAS.

Common channel signaling (CCS)

In CCS, a common channel carries the signaling for all of the channels on that T1 or E1 line. ISDN is an example of CCS, where the D channel is used to carry the signaling for all of the B channels.

Clear channel signaling (Clear)

In this type, none of the channels on the T1 or E1 line are used for signaling purposes. Clear channel signaling is the ability to access telephony channels in the system and configure them to a user-defined call control protocol, or to simply leave the lines 'clear'. The resources should have access to the telephony bus for media routing purposes, as well as signal detection, signal generation, and tone generation capabilities, if desired.

Note: In a clear channel configuration, the CT Bus does not preserve frames, so any in-band signaling is lost. That is, T1 CAS robbed bit signaling cannot be performed on a line configured to use clear channel signaling.

Values:

- 4: CAS
- 5: CCS
- 6: Clear

Guidelines: When using Non-Facility-Associated Signaling (NFAS), Signaling Type is dependent on whether the T1 line is a primary, standby (DCBU), or NFAS ISDN trunk. The primary trunk must be set to CCS, and the standby and NFAS trunks must be set to Clear.

Note: NFAS is supported on ISDN NI-2, 4ESS, 5ESS and DMS protocols, and NFAS D channel backup (DCBU) is supported on ISDN 4ESS, 5ESS, NI-2 protocols.

For additional parameters that need to be modified for NFAS, see [Section 9.3, “\[NFAS\] Parameters”](#), on page 113

Coding (Coding)

Number: 0x1603

Description: The **Coding** parameter defines the coding scheme to be used by a digital line type. Coding schemes include:

Modified alternate mark inversion (B8ZS)

This is a modified AMI code that only applies to T1 lines and is used to preserve one's density on the line. Whenever eight consecutive zeros occur on the line, they are replaced by an 8-bit string that violates the bipolar signaling. If the preceding pulse was positive, the polarity of the substituted eight bits is 000+-0-+. If the preceding pulse was negative, the polarity of the substituted eight bits is 000-+0+-.

Alternate mark inversion (AMI)

This is a bipolar signal conveying binary digits in which each successive 1 (mark) is of the opposite polarity. If the previous mark was a positive pulse, then the next mark will be a negative pulse. Spaces have an amplitude of zero (no pulse).

High density bipolar three zero (HDB3)

High density bipolar three zero is a modified AMI code that only applies to E1 and is used to preserve one's density on the line. Whenever four consecutive zeros appear, the four-zeros group is replaced with an HDB3 code. This could be either of two HDB3 codes, depending on whether there was an odd or even number of ones since the last bipolar violation. If an odd number of ones occurred, the substituted four bits are 000V, where V represents a bipolar

CONFIG File Parameter Reference for Dialogic® HMP Interface Boards

violation. If an even number of ones occurred, the substituted four bits are P00V, where P represents a parity bit and V represents a bipolar violation.

Values:

- 7: B8ZS
- 8: AMI
- 9: HDB3

ZeroCodeSuppression (Zero Code Suppression)

Number: 0x1604

Description: The **ZeroCodeSuppression** parameter is an algorithm used by T1 lines that inserts a 1 bit into a stream to prevent the transmission of eight or more consecutive 0 bits, which could produce timing errors. Instead, this algorithm maintains a minimum one's density to reduce timing errors.

Values:

- 10: Bell - Bell zero code suppression (Jam Bit 7)
- 11: GTE - GTE zero code suppression (Jam Bit 8, except in signaling frames when Jam Bit 7 is used if the signaling bit is 0)
- 12: DDS - Digital Data Service zero code suppression (data byte is replaced with 10011000)
- 13: None - No zero code suppression is used.

Guidelines: The **ZeroCodeSuppression** parameter is used when AMI line-coding is used, that is, when the **Coding** parameter is set to AMI. Since AMI does not perform zero code suppression, the **ZeroCodeSuppression** parameter ensures there are no long strings of consecutive zeros on the line.

If the **Coding** parameter is set to B8ZS or HDB3 (for E1), then zero code suppression is performed by the line-coding and the **ZeroCodeSuppression** parameter is ignored.

FramingAlgorithm (CRC Checking)

Number: 0x1624

Description: A T1 front end can run two different framing algorithms when configured as extended superframe (ESF): a default algorithm and an alternate CRC-6 checking algorithm. The CRC-6 checking algorithm allows the circuit to confirm the CRC-6 bits in the received multiframe, as a guard against mimic framing patterns, before forcing a new frame alignment. The CRC Checking parameter allows you to enable the CRC-6 checking algorithm.

Values:

- 0: Default algorithm
- 1: Alternate CRC-6 checking algorithm

Guidelines: This parameter only applies to T1 trunks whose Line Type parameter (0x1601) is set to 1 (dsx1_ESF). For all other Line Types, this parameter is invalid.

To include this parameter and enable CRC checking, you must edit the applicable CONFIG file by adding the following line at the end of each [lineAdmin] section of the CONFIG file:

```
SetParm=0x1624,1! CRC checking OFF=0 (default), CRC checking ON=1
```

After editing the CONFIG file, you will need to generate a new FCD file. Refer to [Section 4.6, “Modifying the FCD File Parameters”](#), on page 36 for more information.

LOSDeclaredTime (LOS Declared Time)

Number: 0x160c

Description: The **LOSDeclaredTime** parameter defines the number of milliseconds for which no signal is detected at the input port before a loss of signal (LOS) or carrier-failure alarm (CFA) can be declared.

Values: 0 to 2500 (milliseconds)

LOSClearedTime (LOS Cleared Time)

Number: 0x160d

Description: The **LOSClearedTime** parameter defines the number of milliseconds for which a signal must be detected at the input port before a declared LOS or CFA can be cleared.

Values: 0 to 2500 (milliseconds)

REDCFADecay (RED CFA Decay)

Number: 0x1609

Description: The **REDCFADecay** parameter is the denominator of the fraction used to calculate the decay slope in the integration process when RED CFA condition has not been declared and LOS or LOF is intermittent.

Values: 4 to 15 (1/4 to 1/15)

REDCFADeclareTime (RED CFA Declare Time)

Number: 0x160a

Description: The **REDCFADeclareTime** parameter defines the number of milliseconds that a red alarm condition must be received at the input port before a RED CFA condition can be declared.

Values: 0 to 2500 (milliseconds)

REDCFAClearedTime (RED CFA Cleared Time)

Number: 0x160b

Description: The **REDCFAClearedTime** parameter defines the number of milliseconds that a normal signal must be received at the input port before a declared RED CFA condition can be cleared.

Values: 1000 to 15000 (milliseconds)

YellowCFADeclareTime (Yellow CFA Declare Time)

Number: 0x160e

Description: The **YellowCFADeclareTime** parameter defines the number of milliseconds for which a Remote Alarm Indication (RAI) signal is detected at the input port before a yellow CFA condition can be declared.

Values: 0 to 2500 (milliseconds)

YellowCFAClearTime (Yellow CFA Clear Time)

Number: 0x160f

Description: The **YellowCFAClearTime** parameter defines the number of milliseconds for which a RAI signal is not detected at the input port before a declared yellow CFA condition can be cleared.

Values: 0 to 2500 (milliseconds)

RAICRCCFADeclareTime (RAI CRC CFA Declare Time)

Number: 0x1610

Description: The **RAICRCCFADeclareTime** parameter defines the number of seconds for which a RAI signal and CRC Error is detected at the input port before a RAI CRC CFA can be declared.

Values: 0 to 450 (milliseconds)

RAICRCCFAClearTime (RAI CRC CFA Clear Time)

Number: 0x1611

Description: The **RAICRCCFAClearTime** parameter defines the number of seconds for which a RAI signal and Remote CRC Error is not detected at the input port before a declared RAI CRC CFA can be cleared.

Values: 0 to 450 (milliseconds)

InitialBitPattern (Initial CAS Signaling Bit Pattern)

Number: 0x1625

Description: The **InitialBitPattern** parameter defines the values of the CAS ABCD signaling bits that are transmitted for all channels on the specified line at the time the firmware is downloaded and initialized.

Values: 0x0 to 0xf, where the hexadecimal value represents the binary ABCD bit values. For example, 0xd defines the ABCD bit pattern as 1101.

Guidelines: For a T1 line, the default is 0x0. For an E1 line, the default is 0xd.

Initial Alarm State

Number: 0x1626

Description: Trunk preconditioning allows boards to be placed in an alarm state during board initialization.

While Dialogic® boards are starting up and are connected to network trunks, there is a period where the digital network interface begins transmitting frames and idle CAS signaling. This state can exist for a minute or more before the board and application program are prepared to handle calls. During this time, a service provider (CO) may begin alerting (ringing) for inbound calls, but the calls cannot be answered because the board or application has not finished initializing. This results in lost calls.

The Initial Alarm State parameter allows you to place trunks in an alarm state while the board is being initialized. This prevents the service provider from sending calls. The alarm clears and the trunks go inservice as soon as the first **gc_OpenEx()** (or **gc_Open()**) function for a trunk is executed in the application. (For T1 trunks, alarms clear after a 15-second delay to verify valid signaling.)

Values:

- 0: No alarm is transmitted on the trunk; all trunk time slots signal Out of Service (Default)
- 1: TransmitAIS - An Alarm Indication Signal (AIS) alarm is transmitted on the trunk.
- 2: TransmitRAI - A Remote Alarm Indication (RAI) alarm is transmitted on the trunk.

Note: The default behavior also applies if the Initial Alarm State parameter is not used. The Initial Alarm State parameter setting applies only upon board initialization. After the initial alarm state is cleared (by **gc_OpenEx()** or **gc_Open()**), trunks do not return to the initial alarm state unless you restart the board. Stopping the board or unloading the application does not return a board to its initial alarm state.

Note: An RAI alarm could result from a response to a loss of sync from the network side. If the Initial Alarm State parameter is set to 2, but a loss of sync (or similar condition) persists even after the board is initialized and **gc_OpenEx()** or **gc_Open()** is invoked, the RAI will continue to be transmitted until the network condition is cleared.

Note: A board could transmit other alarms, as a response to a network condition, that are unrelated to this parameter. Those alarms will persist until the network condition is cleared.

CONFIG File Parameter Reference for Dialogic® HMP Interface Boards

Guidelines: To use the Initial Alarm State parameter, it must be manually added to the CONFIG file that was selected for your board. The hexadecimal parameter number 0x1626 must be added in the [lineAdmin] section for each trunk on the board. For example:

```
[lineAdmin.1]
SetParm=0x1626,1      ! IntialAlarmState (None=0, AIS=1, RAI=2)

[lineAdmin.2]
SetParm=0x1626,1      ! IntialAlarmState (None=0, AIS=1, RAI=2)

[lineAdmin.3]
SetParm=0x1626,1      ! IntialAlarmState (None=0, AIS=1, RAI=2)

[lineAdmin.4]
SetParm=0x1626,1      ! IntialAlarmState (None=0, AIS=1, RAI=2)
```

BPVS Threshold Range

Number: 0x1639

Description: To support the Dialogic® Global Call Alarm Management System (GCAMS) enhancements, this parameter allows you to change the default threshold value of the Bipolar Violation Count Saturation (BPVS) alarm (T1 or E1 alarm) by adding a parameter in the CONFIG file (.config) that corresponds to the PCD file in use on your board. The change is made per span. After threshold parameters are added, the FCD file is automatically updated when the new PCD file and modified CONFIG files are downloaded to the board.

Values: 0 to 255

Guidelines: To modify the default threshold for the BPVS alarm, add the following parameter (sample value of 100 shown) to the [lineAdmin.x] section of a CONFIG file:

```
SetParm=0x1639,100 ! BPVS threshold range 0 - 255, default 255
```

OOF Threshold Range

Number: 0x163a

Description: To support the Dialogic® Global Call Alarm Management System (GCAMS) enhancements, this parameter allows you to change the default threshold value of the Out of Frame Error Count Saturation (OOF) alarm (T1 alarm) by adding a parameter in the CONFIG file (.config) that corresponds to the PCD file in use on your board. The change is made per span. After threshold parameters are added, the FCD file is automatically updated when the new PCD file and modified CONFIG files are downloaded to the board.

Values: 0 to 255

Guidelines: To modify the default threshold for the OOF alarm, add the following parameter (sample value of 100 shown) to the [lineAdmin.x] section of a CONFIG file:

```
SetParm=0x163a,100 ! OOF threshold range 0 - 255, default 0
```

FERR Threshold Range

Number: 0x163b

Description: To support the Dialogic® Global Call Alarm Management System (GCAMS) enhancements, this parameter allows you to change the default threshold value of the Two out of

Four Consecutive Frame Bits (F bit) in Error (FERR) alarm (T1 alarm) by adding a parameter in the CONFIG file (.config) that corresponds to the PCD file in use on your board. The change is made per span. After threshold parameters are added, the FCD file is automatically updated when the new PCD file and modified CONFIG files are downloaded to the board.

Values: 0 to 255

Guidelines: To modify the default threshold for the FERR alarm, add the following parameter (sample value of 100 shown) to the [lineAdmin.x] section of a CONFIG file:

```
SetParm=0x163b,100 ! FERR threshold range 0 - 255, default 0
```

ECS Threshold Range

Number: 0x163c

Description: To support the Dialogic® Global Call Alarm Management System (GCAMS) enhancements, this parameter allows you to change the default threshold value of the Frame Bit Error Count Saturation (ECS) alarm (T1 or E1 alarm) by adding a parameter in the CONFIG file (.config) that corresponds to the PCD file in use on your board. The change is made per span. After threshold parameters are added, the FCD file is automatically updated when the new PCD file and modified CONFIG files are downloaded to the board.

Values: 0 to 255

Guidelines: To modify the default threshold for the ECS alarm, add the following parameter (sample value of 100 shown) to the [lineAdmin.x] section of a CONFIG file:

```
SetParm=0x163c,100 ! ECS threshold range 0 - 255, default 0
```

CECS Threshold Range

Number: 0x163d

Description: To support the Dialogic® Global Call Alarm Management System (GCAMS) enhancements, this parameter allows you to change the default threshold value of the CRC4 Error Count Saturation (CECS) alarm (E1 alarm) by adding a parameter in the CONFIG file (.config) that corresponds to the PCD file in use on your board. The change is made per span. After threshold parameters are added, the FCD file is automatically updated when the new PCD file and modified CONFIG files are downloaded to the board.

Values: 0 to 255

Guidelines: To modify the default threshold for the CECS alarm, add the following parameter (sample value of 100 shown) to the [lineAdmin.x] section of a CONFIG file:

```
SetParm=0x163d,100 ! CECS threshold range 0 - 255, default 255
```

9.3 [NFAS] Parameters

Non-Facility-Associated Signaling (NFAS) uses a single ISDN PRI D channel to provide signaling and control for multiple ISDN PRI lines. When using NFAS, modifications also need to be made to other sections of the CONFIG file. For details, see the following:

- “[SignalingType \(Signaling Type\)](#)”, on page 106.

- [Section 9.4, “\[NFAS.x\] Parameters”](#), on page 114.

There is only one NFAS component level parameter.

NFAS_INSTANCE_MAP (NFAS Instance Map)

Number: 0x3E02

Description: The **NFAS_INSTANCE_MAP** parameter defines the number of NFAS groups or NFAS instances created on a particular board. One NFAS group is created for each primary D channel on the board.

Values:

- 0x0: 0 (0000)
- 0x1: 1 (0001)
- 0x3: 2 (0011)
- 0x7: 3 (0111)
- 0xF: 4 (1111)

Guidelines: The **NFAS_INSTANCE_MAP** parameter value is a hexadecimal bitmap that represents the number of NFAS groups that are needed. The bitmap’s least significant bit correlates to the first NFAS instance, the next least significant bit corresponds to the second NFAS instance, and so on. So, starting with the least significant bit and working towards the most significant bit, set each bit’s value to 1 for each NFAS instance needed. For example, to create three NFAS groups, set the value of the **NFAS_INSTANCE_MAP** parameter to 0x07 (0111).

9.4 [NFAS.x] Parameters

Non-Facility-Associated Signaling (NFAS) uses a single ISDN PRI D channel to provide signaling and control for multiple ISDN PRI lines. For each group defined by the **NFAS_INSTANCE_MAP** parameter, there will be an [NFAS.x] section in the CONFIG file. For example, [NFAS.1] corresponds to the NFAS instance for the first group, [NFAS.2] corresponds to the NFAS instance for the second group, and so on.

When using NFAS, modifications also need to be made to other sections of the CONFIG file. For details, see the following parameters:

- [“NFAS_INSTANCE_MAP \(NFAS Instance Map\)”](#), on page 114.
- [“SignalingType \(Signaling Type\)”](#), on page 106

NFAS instance level parameters include:

- [GroupID \(Group Identifier\)](#)
- [NFAS_PrimaryIntID \(Primary Instance Identifier\)](#)
- [NFAS_Standby_IntID \(Standby Instance Identifier\)](#)

GroupID (Group Identifier)

Number: 0x3E00

Description: The **GroupID** parameter is defined for each NFAS group created. This parameter defines the NFAS group including the trunks that are assigned to it.

Values: 1 to 4

Guidelines: When setting this parameter, the trunks assigned to the group must also be defined. For each group, multiple trunks are identified and added in recurring sets of triplets, using the following command:

```
AddNFASInterface(x)= a,b,c, a',b',c', ...
```

Where:

x = GroupID

NFAS group into which the interface needs to be added. For [NFAS.x], this would be “x”.

a = InterfaceID

Unique number for this interface assigned by the user. A maximum of 10 interfaces can be assigned to a single group.

b = BoardNumber

Logical board number (as defined by the **Logical ID** parameter) on which the trunk being assigned to the InterfaceID resides.

c = InstanceNumber

Instance number of the trunk that is being assigned to the InterfaceID. Trunks are numbered sequentially based on their physical location on the boards, from top to bottom.

For example, to add all four trunks on board 2 and the first two trunks on board 3 to the fourth NFAS group, enter the following to the [NFAS.4] section in the CONFIG file:

```
[NFAS.4]
AddNFASInterface(4)=0,2,1, 1,2,2, 2,2,3, 3,2,4, 4,3,1, 5,3,2
SetParm=0x3E04,0
```

NFAS_PrimaryIntID (Primary Instance Identifier)

Number: 0x3E04

Description: The **NFAS_PrimaryIntID** parameter defines the primary D channel used by the NFAS group and is set for every [NFAS.x] group that is created.

Values: 0 to 9 (valid **InterfaceID** value)

Guidelines: The parameter is set to one of the [NFAS.x] InterfaceIDs defined by the **GroupID** parameter’s AddNFASInterface command. For details, see “**GroupID (Group Identifier)**”, on page 115.

For example, to define the primary D channel for NFAS group 4 to be the second trunk on board 3, enter the following to the [NFAS.4] section in the CONFIG file:

```
[NFAS.4]
AddNFASInterface(4)=0,2,1, 1,2,2, 2,2,3, 3,2,4, 4,3,1, 5,3,2
SetParm=0x3e04,5
```

NFAS_Standby_IntID (Standby Instance Identifier)

Number: 0x3E05

Description: The **NFAS_Standby_IntID** parameter defines the standby, or backup, D channel used by the NFAS group. This parameter is set for every [NFAS.x] group that implements D channel backup (DCBU).

Note: DCBU is supported on Dialogic® boards using ISDN 4ESS, 5ESS, and NI-2 protocols.

Values: 0 to 9 (valid **InterfaceID** value)

Guidelines: The parameter is set to one of the [NFAS.x] InterfaceIDs defined by the **GroupID** parameter's **AddNFASInterface** command. For details about the **AddNFASInterface** command, see “**GroupID (Group Identifier)**”, on page 115.

In the example:

```
[NFAS.4]
AddNFASInterface(4)=0,2,1, 1,2,2, 2,2,3, 3,2,4, 4,3,1, 5,3,2
SetParm=0x3e04,5
```

to define the first trunk on board 2 the standby D channel for the fourth NFAS group, add parameter 0x3e05 to the [NFAS.4] section of the CONFIG file and set it to a value of 0:

```
[NFAS.4]
AddNFASInterface(4)=0,2,1, 1,2,2, 2,2,3, 3,2,4, 4,3,1, 5,3,2
SetParm=0x3e04,5
SetParm=0x3e05,0
```

9.5 [CCS] Parameters

Common Channel Signaling (CCS) supports ISDN PRI out-of-band signaling utilizing the Q.931 signaling protocol for messaging. The parameters in the [CCS] and [CCS.x] sections of the CONFIG file define the number of CCS component instances created and configure the parameters associated with each CCS instance.

The CCS parameters include:

- **INSTANCE_MAP** (Instance Map)
- **CCS_TMR_302** (Q.931 Timer 302)
- **CCS_TMR_303** (Q.931 Timer 303)
- **CCS_TMR_304** (Q.931 Timer 304)
- **CCS_TMR_305** (Q.931 Timer 305)
- **CCS_TMR_308** (Q.931 Timer 308)
- **CCS_TMR_310** (Q.931 Timer 310)
- **CCS_TMR_313** (Q.931 Timer 313)
- **CCS_TEI_RETRY** (TEI Retry Timer)
- **CCS_TEI_STABILITY** (TEI Stability Timer)
- **SYMMETRICAL_LINK** (Symmetrical Command Response Protocol)
- **CCS_PROTOCOL_MODE** (ISDN Protocol Mode)

- [CCS_SWITCH_TYPE](#) (Switch Type)
- [L2_TRACE](#) (Layer 2 Access Flag)

INSTANCE_MAP (Instance Map)

Number: 0x05

Description: The **INSTANCE_MAP** parameter is a bitmap that defines the number of CCS instances created. A CCS instance is created for each network interface that supports common channel signaling. The bitmap's least significant bit corresponds to the CCS instance associated with the first network interface on the board. The next least significant bit corresponds to the CCS instance associated with the second network interface on the board, and so on. If the bit associated with a network interface has a value of 1, then a CCS instance is created for that network interface. For example, a value of 0x5 (0101) means that CCS instances 1 and 3 are created allowing for common channel signaling on network interfaces 1 and 3.

Values: 0 to 0xffff

CCS_TMR_302 (Q.931 Timer 302)

Number: 0x14

Description: The **CCS_TMR_302** parameter is an ISDN Layer 3 timer. For exact timer definitions, refer to the Q.931 specification and the switch specifications.

Note: This parameter only applies to E1 boards.

Values:

- 0: Use the default value for the switch (15000 ms)
- -1: Disable the timer (has the same effect as setting the timer value to 0)
- n > 1: Timer value (milliseconds)

CCS_TMR_303 (Q.931 Timer 303)

Number: 0x0b

Description: The **CCS_TMR_303** parameter is an ISDN Layer 3 timer. For exact timer definitions, refer to the Q.931 specification and the switch specifications.

Values:

- 0: Use the default value for the switch (4000 ms)
- -1: Disable the timer (has the same effect as setting the timer value to 0)
- n > 1: Timer value (milliseconds)

CCS_TMR_304 (Q.931 Timer 304)

Number: 0x0c

Description: The **CCS_TMR_304** parameter is an ISDN Layer 3 timer. For exact timer definitions, refer to the Q.931 specification and the switch specifications.

Note: This parameter only applies to E1 boards.

Values:

- 0: Use the default value for the switch (30000 ms)
- -1: Disable the timer (has the same effect as setting the timer value to 0)
- n > 1: Timer value (milliseconds)

CCS_TMR_305 (Q.931 Timer 305)

Number: 0x0d

Description: The **CCS_TMR_305** parameter is an ISDN Layer 3 timer. For exact timer definitions, refer to the Q.931 specification and the switch specifications.

Values:

- 0: Use the default value for the switch (4000 ms for T1, 30000 ms for E1)
- -1: Disable the timer (has the same effect as setting the timer value to 0)
- n > 1: Timer value (milliseconds)

CCS_TMR_308 (Q.931 Timer 308)

Number: 0x0e

Description: The **CCS_TMR_308** parameter is an ISDN Layer 3 timer. For exact timer definitions, refer to the Q.931 specification and the switch specifications.

Values:

- 0: Use the default value for the switch (4000 ms)
- -1: Disable the timer (has the same effect as setting the timer value to 0)
- n > 1: Timer value (milliseconds)

CCS_TMR_310 (Q.931 Timer 310)

Number: 0x0f

Description: The **CCS_TMR_310** parameter is an ISDN Layer 3 timer. For exact timer definitions, refer to the Q.931 specification and the switch specifications.

Values:

- 0: Use the default value for the switch (10000 ms)
- -1: Disable the timer (has the same effect as setting the timer value to 0)
- n > 1: Timer value (milliseconds)

CCS_TMR_313 (Q.931 Timer 313)

Number: 0x10

Description: The **CCS_TMR_313** parameter is an ISDN Layer 3 timer. For exact timer definitions, refer to the Q.931 specification and the switch specifications.

Values:

- 0: Use the default value for the switch (4000 ms)
- -1: Disable the timer (has the same effect as setting the timer value to 0)
- n > 1: Timer value (milliseconds)

CCS_TEI_RETRY (TEI Retry Timer)

Number: 0x15

Description: The **CCS_TEI_RETRY** parameter defines the maximum amount of time that the data link remains in state 4 (TEI_ASSIGNED) before transitioning to state 5 (TEI_WAIT_ESTABLISH).

Values: Time (milliseconds)

CCS_TEI_STABILITY (TEI Stability Timer)

Number: 0x16

Description: The **CCS_TEI_STABILITY** parameter defines the minimum transition time between data link state 4 (TEI_ASSIGNED) and data link state 5 (TEI_WAIT_ESTABLISH).

Values: 0 to 100,000 (milliseconds)

SYMMETRICAL_LINK (Symmetrical Command Response Protocol)

Number: 0x13

Description: The **SYMMETRICAL_LINK** parameter enables or disables symmetrical data link operations.

Values:

- 0: Disable symmetrical data link operations
- 1: Enable symmetrical data link operations

CCS_PROTOCOL_MODE (ISDN Protocol Mode)

Number: 0x17

Description: The **CCS_PROTOCOL_MODE** parameter sets the network user-side protocol. User-side protocol is also known as TE (terminal emulation) protocol and Network-side protocol

CONFIG File Parameter Reference for Dialogic® HMP Interface Boards

is also known as NT (network termination) protocol. This parameter also can be used to configure QSIG Master/Slave.

Note: Master/Slave mode pertains to QSIG protocols only.

Note: With the exception of the QSIG protocol (where the User-side and Network-side protocols are symmetrical), using the CSS_PROTOCOL_MODE parameter to configure a Network-side protocol is supported for back-to-back testing purposes only. The Network-side firmware is not fully qualified for operation in a deployment environment.

Values:

- 0: User or Slave Mode (QSIG)
- 1: Network or Master Mode (QSIG)

CCS_SWITCH_TYPE (Switch Type)

Number: 0x07

Description: The CCS_SWITCH_TYPE parameter defines the network switch type.

Values:

- 1: 4ESS
- 2: 5ESS
- 3: DMS
- 4: NTT
- 6: DASS2
- 7: NET5
- 10: QSIGE1
- 11: QSIGT1
- 12: NI2
- 13: DPNSS

L2_TRACE (Layer 2 Access Flag)

Number: 0x09

Description: The L2_TRACE parameter is the ISDN Layer 2 access flag. When Layer 2 (Data Link layer) access is disabled, ISDN Link Access Protocol for the D channel (LAPD) functionality is obtained by accessing ISDN Call Control and Layer 3 (Network layer). When Layer 2 access is enabled, call control is no longer supported for the channels on this line and ISDN LAPD functionality is obtained by accessing Layer 2 directly.

Values:

- 0: Disable Layer 2 access
- 1: Enable Layer 2 access

9.6 [CHP] Parameters

The Channel Protocol (CHP) component implements the telephony communication protocol that is used on the network interface. The CHP component parameters include:

- [R4Compatibility](#) (R4 Compatibility Flag)
- [InitialChanState](#) (Initial Channel State)
- [DisableBlock](#) (Disable Block)

R4Compatibility (R4 Compatibility Flag)

Number: 0x1310

Description: The **R4Compatibility** parameter enables or disables R4 (Dialogic® Global Call API) compatibility features. This parameter also enables retrieval of DNIS and ANI information in the offered call state.

Values:

- 0 [default]: Disable R4 compatibility (same effect as the value 2)
- 1: Enable R4 compatibility
- 2: Disable R4 compatibility (same effect as the value 0)

InitialChanState (Initial Channel State)

Number: 0x1311

Description: The **InitialChanState** parameter defines the initial B channel state (CHP channel state) at the end of system initialization. The initial state of the ISDN B channel is either InService or OutOfService. Once the board is initialized, this initial state will be set on all channels of the board until a user application is invoked and explicitly modifies the state of the channel.

Values:

- 1: InService
- 2: OutOfService

Guidelines: This parameter must be set to OutOfService for ISDN protocols.

DisableBlock (Disable Block)

Number: 0x1312

Description: The **DisableBlock** parameter defines whether or not a blocking pattern (message) is sent on a channel when the channel is in the OutofService state. When **DisableBlock** is disabled, no pattern is sent (the switch will not present calls to the B channel).

When **DisableBlock** is enabled and a channel is in the InService state (**InitialChanState=1**), the protocol will send a non-blocking pattern on the channel (the switch will present calls to the B channel). When **DisableBlock** is enabled and a channel is in the OutofService state (**InitialChanState=2**), the protocol will send a blocking pattern on the channel (the switch will

present calls to the B channel but these calls will be abandoned by the switch since the application will not respond to the call).

Values:

- 0: Disable blocking
- 1: Enable blocking

9.7 [CHP] ISDN Protocol Variant Definitions

The CHP parameters define line configurations. Within the [CHP] section of the CONFIG file, ISDN protocol variants are defined using the `Variant Define n` command. For a detailed description of the `Variant Define n` command, see [Section 7.5, “\[CHP\] Section”](#), on page 87.

The ISDN protocol variant parameters include:

- `ProtocolType` (Protocol Type)
- `InterCallDelay` (Inter-call Delay)
- `DisconnectTimeout` (Disconnect Timeout)
- `Layer1Protocol` (Layer 1 Protocol)
- `InfoTransferRate` (Information Transfer Rate)
- `InfoTransferCap` (Information Transfer Cap)
- `CalledNumberType` (Called Number Type)
- `CalledNumberPlan` (Called Number Plan)
- `CalledNumberCount` (Called Number Count)
- `CallingNumberType` (Calling Number Type)
- `CallingNumberPlan` (Calling Number Plan)
- `CallingNumberPresentation` (Calling Number Presentation)
- `CallingNumberScreening` (Calling Number Screening)
- `CallingNumberCount` (Calling Number Count)
- `CallProgress` (Call Progress)
- `CaHdgLoHiGl` (Hello Edge/Low Glitch/High Glitch)
- `CaAnsdglPSV` (Answer Deglitcher/PAMD Speed Value)
- `CaHdgLoHiGl` (Hello Edge/Low Glitch/High Glitch)
- `CaBusySet` (Busy Signal)
- `CaSitSet` (SIT Signal)
- `CaFaxSet` (Fax Signal)
- `CaPvdId` (Voice Detection Signal)
- `CaPamdId` (Answering Machine Signal)
- `CaSignalTimeout` (Signal Timeout)
- `CaAnswerTimeout` (Answer Timeout)

- [CaPvdTimeout \(Voice Detection Timeout\)](#)

ProtocolType (Protocol Type)

Description: The **ProtocolType** parameter defines the type of ISDN protocol used on a channel. The value of the parameter is dependent on the firmware being downloaded and the CONFIG files used. For example, when downloading the *ghmp1_hmpdsb_2_4ess.config* file, **ProtocolType** should be set to a value of 1.

Note: The **ProtocolType** parameter is also used when defining T1 protocol variants.

Values:

- 1: 4ESS
- 2: 5ESS
- 3: DMS100 and DMS250
- 4: NTT
- 7: NET5
- 8: DASS2
- 9: DPNSS
- 10: QSIGE1
- 11: QSIGT1
- 12: NI2

InterCallDelay (Inter-call Delay)

Description: The **InterCallDelay** parameter defines the minimum amount of time between outbound calls.

Note: The **InterCallDelay** parameter is also used when defining T1 protocol variants.

Values: $n > 0$ (milliseconds)

DisconnectTimeout (Disconnect Timeout)

Description: The **DisconnectTimeout** parameter defines the time delay between proceeding and alert/connect. The call will transition to idle after this time period (sooner if ClearConf is received).

Note: The **DisconnectTimeout** parameter is also used when defining T1 protocol variants.

Values: $n > 0$ (milliseconds)

Guidelines: None.

Layer1Protocol (Layer 1 Protocol)

Description: The **Layer1Protocol** parameter defines the User Layer 1 Protocol.

Values:

- 0x00: Protocol not present
- 0x01: CCITT
- 0x02: G.711 mu-law
- 0x03: G.711 A-law
- 0x04: G.721 ADPCM
- 0x05: G.721 kHz
- 0x06: 384 kHz Video
- 0x07: NS Rate Adaption
- 0x08: V120 Rate Adaption
- 0x09: X.31 HDLC

InfoTransferRate (Information Transfer Rate)

Description: The **InfoTransferRate** parameter defines the information transfer rate.

Values:

- 0x00: Rate undefined
- 0x10: 64 kbps
- 0x11: 128 kbps
- 0x13: 384 kbps
- 0x15: 1536 kbps
- 0x17: 1920 kbps
- 0x18: Multi-rate

InfoTransferCap (Information Transfer Cap)

Description: The **InfoTransferCap** parameter defines the information transfer capability.

Values:

- 0x00: Speech
- 0x08: Unrestricted digital
- 0x09: Restricted digital
- 0x10: 3 kHz
- 0x11: 7 kHz
- 0x18: Video

CalledNumberType (Called Number Type)

Description: The **CalledNumberType** parameter defines the type of outbound calls (Called Party Numbers).

Values:

- 0x00: Unknown
- 0x01: International
- 0x02: National
- 0x03: Network specific
- 0x04: Network subscriber
- 0x06: Network abbreviated

CalledNumberPlan (Called Number Plan)

Description: The **CalledNumberPlan** parameter defines the numbering plan to use for outbound calls (Called Party Numbers).

Values:

- 0x00: Unknown
- 0x01: ISDN
- 0x02: Telephony
- 0x03: Date X.121
- 0x04: Telex F.69
- 0x08: National standard
- 0x09: Private

CalledNumberCount (Called Number Count)

Description: The **CalledNumberCount** parameter defines the number of digits to collect from an incoming call.

Values:

- 0: Collect all the digits provided
- n: Number of digits to collect

CallingNumberType (Calling Number Type)

Description: The **CallingNumberType** parameter defines the type of outbound call (Calling Party Number).

Values:

- 0x00: Unknown
- 0x01: International
- 0x02: National
- 0x03: Network specific
- 0x04: Network subscriber
- 0x06: Network abbreviated

CallingNumberPlan (Calling Number Plan)

Description: The **CallingNumberPlan** parameter defines the numbering plan to use for outbound calls (Calling Party Numbers).

Values:

- 0x00: Unknown
- 0x01: ISDN
- 0x02: Telephony
- 0x03: Date X.121
- 0x04: Telex F.69
- 0x08: National standard
- 0x09: Private

CallingNumberPresentation (Calling Number Presentation)

Description: The **CallingNumberPresentation** parameter defines the presentation for calling number (outbound calls).

Values:

- 0x00: Allowed
- 0x01: Restricted
- 0x02: Not available

CallingNumberScreening (Calling Number Screening)

Description: The **CallingNumberScreening** parameter defines the screening for calling number (outbound calls).

Values:

- 0x00: User provided
- 0x01: Verified and passed
- 0x02: Verified and failed
- 0x03: Network provided

CallingNumberCount (Calling Number Count)

Description: The **CallingNumberCount** parameter defines the number of Calling Party Number digits to collect from incoming call.

Values:

- 0: Collect all the digits provided
- n: Number of digits to collect

CallProgress (Call Progress)

Description: The **CallProgress** parameter enables or disables call progress detection for call setup.

Note: The **CallProgress** parameter is also used when defining T1 protocol variants.

Values:

- y: Enable call progress detection
- n: Disable call progress detection

CaHdgLoHiGl (Hello Edge/Low Glitch/High Glitch)

The **CaHdgLoHiGl** parameter combines three parameters into one. They include the Hello Edge, Low Glitch, and High Glitch parameters. The values for all three parameters are contained in the **CaHdgLoHiGl** parameter value, 0xFF020F13, where 02 is the default hexadecimal value (2 decimal) for the Hello Edge parameter, 0F is the default hexadecimal value (15 decimal) for the Low Glitch parameter, and 13 is the hexadecimal value (19 decimal) for the High Glitch parameter.

Description: The **Hello Edge** parameter defines the point at which a connect will be returned to the application.

Values:

- 1: Rising edge (immediately when a connect is detected)
- 2: Falling edge (after the end of the salutation)

Description: The **Low Glitch** parameter defines, in intervals of 10 milliseconds, the maximum silence period to ignore. This maximum silence period helps to eliminate spurious silence intervals.

Values: The default value is 15 decimal (150 milliseconds).

Description: The **High Glitch** parameter defines, in intervals of 10 milliseconds, the maximum nonsilence period to ignore. This maximum nonsilence period helps to eliminate spurious nonsilence intervals.

Values: The default value is 19 decimal (190 milliseconds).

CaAnsdgIPSV (Answer Deglitcher/PAMD Speed Value)

The **CaAnsdgIPSV** parameter combines two parameters into one. They include the Answer Deglitcher and PAMD Speed Value parameters. The values for both parameters are contained in

CONFIG File Parameter Reference for Dialogic® HMP Interface Boards

the **CaAnsdglPSV** parameter value, 0xFFFFFFFF01, where 01 is the default hexadecimal value (1 decimal) for the PAMD Speed Value parameter and FF is the default hexadecimal value (-1 decimal) for the Answer Deglitcher parameter, which corresponds to disabling it. This parameter should only be enabled if you are concerned with measuring the length of the salutation.

Description: The **Answer Deglitcher** parameter defines the maximum silence period, in 10 millisecond intervals, allowed between words in a salutation.

Values: The default value is -1 (FFFF), for disabled.

Description: The **PAMD Speed Value** parameter defines the PAMD algorithm: PAMD_ACCU, PAMD_FULL, and PAMD_QUICK. PAMD_QUICK provides the fastest results based on the connect circumstances, but is the least accurate. PAMD_FULL performs hiss noise analysis to determine if this is an answer machine response, and then performs a full evaluation of the voice response if the hiss information is not sufficient to make the decision. PAMD_ACCU will not perform hiss noise analysis, since this is not required with today's digital answering systems, but will perform a full answer size voice response to achieve the most accurate result.

Values:

- 1 [default]: PAMD_ACCU
- 2: PAMD_FULL
- 3: PAMD_QUICK

CaRingingSet (Ringing Signal)

Description: The **CaRingingSet** parameter defines the signal set used to detect ringing for call progress analysis.

Note: The **CaRingingSet** parameter is also used when defining T1 protocol variants.

Values: 0x024940

CaBusySet (Busy Signal)

Description: The **CaBusySet** parameter defines the signal set used to detect busy for call progress analysis.

Note: The **CaBusySet** parameter is also used when defining T1 protocol variants.

Values: 0x004DE0

CaSitSet (SIT Signal)

Description: The **CaSiteSet** parameter defines the signal set used to detect Special Information Tones (SIT) tones for call progress analysis.

Note: The **CaSiteSet** parameter is also used when defining T1 protocol variants.

Values: 0x02F240

CaFaxSet (Fax Signal)

Description: The **CaFaxSet** parameter defines the signal set used to detect fax tones for call progress analysis.

Note: The **CaFaxSet** parameter is also used when defining T1 protocol variants.

Values: 0x014B80

CaPvId (Voice Detection Signal)

Description: The **CaPvId** parameter defines the signal to use for positive voice detection in call progress analysis.

Note: The **CaPvId** parameter is also used when defining T1 protocol variants.

Values: 0x01F4C1

CaPamId (Answering Machine Signal)

Description: The **CaPamId** parameter defines the signal to use for positive answering machine detection in call progress analysis.

Note: The **CaPamId** parameter is also used when defining T1 protocol variants.

Values: 0x01A041

CaSignalTimeout (Signal Timeout)

Description: The **CaSignalTimeout** parameter defines the maximum amount of time to wait to detect a call progress tone from one of the call analysis signal sets. For T1 loop start and ground start protocols, if this time is exceeded, then the outbound call will fail with the reason being NoAnswer.

Note: The **CaSignalTimeout** parameter is also used when defining T1 protocol variants.

Values: $n > 0$ (the value must be a multiple of 10 ms)

CaAnswerTimeout (Answer Timeout)

Description: The **CaAnswerTimeout** parameter defines the maximum amount of time that call analysis will wait for ringback to stop (equivalent to the number of rings). If this time is exceeded, then the outbound call will fail with the reason being NoAnswer.

Note: The **CaAnswerTimeout** parameter is also used when defining T1 protocol variants.

Values: $n > 0$ (the value must be a multiple of 10 ms)

CaPvdTimeout (Voice Detection Timeout)

Description: The **CaPvdTimeout** parameter defines the maximum amount of time that call analysis will wait to detect positive answering machine detection (PAMD) or positive voice detection (PVD) once ringback has ceased. If this time is exceeded, then the call state will

transition to “Connected” with the reason being Normal. If PAMD or PVD is detected within this time period, then the “Connected” reason will be PAMD or PVD respectively.

Note: The **CaPvdTimeout** parameter is also used when defining T1 protocol variants.

Values: $n > 0$ (the value is expressed in multiples of 10 milliseconds. For example, a value of 200 equals 2000 milliseconds, or 2 seconds)

- For digital boards: default = 400

9.8 [TSC] Parameters

The parameter in the [TSC] section of the CONFIG file is associated with the B channel sets.

Encoding (Encoding Method)

Number: 0x1209

Description: The **Encoding** parameter defines the encoding method used on a line.

Values:

- 1: A-law
- 2: mu-law

9.9 [TSC] defineBSet Parameters

The parameters defined by the `defineBSet` command in the [TSC] section of the CONFIG file are associated with the B channel sets. The syntax of the `defineBSet` command is:

```
defineBSet = SetId, LineId, StartChan, NumChans, BaseProtocol, Inbound, OutBound, DChanDesc, Admin, Width, BChanId, SlotId, Direction, Count, [BChanId, SlotId, Direction, Count,] 0
```

Note: The [TSC] `defineBSet` parameters do not have parameter numbers explicitly defined within the CONFIG file.

The `defineBSet` parameters include:

- [SetId \(Set Identifier\)](#)
- [LineId \(Line Identifier\)](#)
- [StartChan \(Start Channel\)](#)
- [NumChans \(Number of B Channels\)](#)
- [BaseProtocol \(Base Protocol\)](#)
- [Inbound \(Inbound Variant\)](#)
- [Outbound \(Outbound Variant\)](#)
- [DChanDesc \(D Channel Identifier\)](#)
- [Admin \(Admin\)](#)
- [Width \(Width\)](#)

- [BChanId \(B Channel Identifier\)](#)
- [SlotId \(Slot Identifier\)](#)
- [Direction \(Direction\)](#)
- [Count \(Count\)](#)

SetId (Set Identifier)

Description: The **SetId** parameter is an arbitrary identifier set by the user that identifies the B channel set in which the B channels are a member.

Values: Number

Guidelines: Each B channel set must have a unique identifier.

For example, for each line on a board, **SetId** can be set sequentially to a value that is a multiple of 10 as follows:

```
defineBSet=10,1,1,23, 0,1,1,1,20,1, 1,1,3,23,0
defineBSet=20,2,1,23, 0,1,1,2,20,1, 1,1,3,23,0
defineBSet=30,3,1,23, 0,1,1,3,20,1, 1,1,3,23,0
defineBSet=40,4,1,23, 0,1,1,4,20,1, 1,1,3,23,0
```

LineId (Line Identifier)

Description: The **LineId** parameter defines the T1 or E1 line that carries all of the B channels in the set.

Values: 1 to 16

Guidelines: For example, on a board with four network interfaces, the value of **LineId** is set to 1 for line 1, 2 for line 2, and so on for each line as follows:

```
defineBSet=10,1,1,23, 0,1,1,1,20,1, 1,1,3,23,0
defineBSet=20,2,1,23, 0,1,1,1,20,1, 1,1,3,23,0
defineBSet=30,3,1,23, 0,1,1,1,20,1, 1,1,3,23,0
defineBSet=40,4,1,23, 0,1,1,1,20,1, 1,1,3,23,0
```

StartChan (Start Channel)

Description: The **StartChan** parameter defines the first B channel in the set. This parameter is used in combination with the **NumChans** parameter to define a contiguous set of B channels.

Values: The value range depends on the technology, because the number of available B channels varies.

- 1 to 24: T1
- 1 to 30: E1
- 1 to 31: E1 clear channel

Guidelines: For example, on a T1 line where 23 of the 24 channels are used as B channels, the value of **StartChan** is set to 1 as follows:

```
defineBSet=10,1,1,23, 0,1,1,1,20,1, 1,1,3,23,0
defineBSet=20,2,1,23, 0,1,1,1,20,1, 1,1,3,23,0
defineBSet=30,3,1,23, 0,1,1,1,20,1, 1,1,3,23,0
defineBSet=40,4,1,23, 0,1,1,1,20,1, 1,1,3,23,0
```

NumChans (Number of B Channels)

Description: The **NumChans** parameter defines the total number of B channels in the set. This parameter is used in combination with the **StartChan** parameter to define a contiguous set of B channels.

Values: The range of values varies with technology because the number of time slots varies.

- 1 to 24: T1
- 1 to 30: E1
- 1 to 31: E1 clear channel

Guidelines: For example, on a T1 line, a value of 1 for **StartChan** and a value of 23 for **NumChans** defines 23 B channels numbered from 1 to 23:

```
defineBSet=10,1,1,23, 0,1,1,1,20,1, 1,1,3,23,0  
defineBSet=20,2,1,23, 0,1,1,2,20,1, 1,1,3,23,0  
defineBSet=30,3,1,23, 0,1,1,3,20,1, 1,1,3,23,0  
defineBSet=40,4,1,23, 0,1,1,4,20,1, 1,1,3,23,0
```

BaseProtocol (Base Protocol)

Description: The **BaseProtocol** parameter defines the base protocol on which the B channel set will run.

Values:

- 0: T1 CAS, ISDN or Dialogic® Global Call protocols (where the default protocol is defined by the firmware) or clear channel

Guidelines: For T1 CAS, ISDN, and Dialogic® Global Call protocols, each firmware load supports only one base protocol, so this parameter will be set to 0 for these protocols. This parameter is also set to 0 for clear channel. Clear channel is the ability to access telephony channels in the system and configure them to a user-defined call control protocol, or to simply leave the lines “clear”. The resources should have access to the telephony bus for media routing purposes, as well as signal detection, signal generation, and tone generation capabilities, if desired.

For example, on T1 ISDN lines, **BaseProtocol** is set to a value of 0 as follows:

```
defineBSet=10,1,1,23, 0,1,1,1,20,1, 1,1,3,23,0  
defineBSet=20,2,1,23, 0,1,1,1,20,1, 1,1,3,23,0  
defineBSet=30,3,1,23, 0,1,1,1,20,1, 1,1,3,23,0  
defineBSet=40,4,1,23, 0,1,1,1,20,1, 1,1,3,23,0
```

Inbound (Inbound Variant)

Description: The **Inbound** parameter selects one of the protocol type variant parameter sets defined in the [CHP] section of the CONFIG file to use for inbound calls. The protocol variant defines the type of protocol running on the set of B channels.

Values:

- 0: Clear channel (disable inbound calls)
- n: Variant identifier as defined in the [CHP] section of the CONFIG file

Guidelines: This parameter is set to 0 for clear channel. Clear channel is the ability to access telephony channels in the system and configure them to a user-defined call control protocol, or to simply leave the lines “clear”. The resources should have access to the telephony bus for media routing purposes, as well as signal detection, signal generation, and tone generation capabilities, if desired.

For example, on T1 ISDN lines, **Inbound** is set to a value of 1 as follows:

```
defineBSet=10,1,1,23, 0,1,1,1,20,1, 1,1,3,23,0
defineBSet=20,2,1,23, 0,1,1,1,20,1, 1,1,3,23,0
defineBSet=30,3,1,23, 0,1,1,1,20,1, 1,1,3,23,0
defineBSet=40,4,1,23, 0,1,1,1,20,1, 1,1,3,23,0
```

Outbound (Outbound Variant)

Description: The **Outbound** parameter selects one of the protocol type variant parameter sets defined in the [CHP] section of the CONFIG file to use for outbound calls. The protocol variant defines the type of protocol running on the set of B channels.

Values:

- 0: Clear channels (disable outbound calls)
- n: Variant identifier as defined in the [CHP] section of the CONFIG file

Guidelines: This parameter is set to 0 for clear channel (disable outbound calls). Clear channel is the ability to access telephony channels in the system and configure them to a user-defined call control protocol, or to simply leave the lines “clear”. The resources should have access to the telephony bus for media routing purposes, as well as signal detection, signal generation, and tone generation capabilities, if desired.

For example, on T1 ISDN lines, **Outbound** is set to a value of 1 as follows:

```
defineBSet=10,1,1,23, 0,1,1,1,20,1, 1,1,3,23,0
defineBSet=20,2,1,23, 0,1,1,1,20,1, 1,1,3,23,0
defineBSet=30,3,1,23, 0,1,1,1,20,1, 1,1,3,23,0
defineBSet=40,4,1,23, 0,1,1,1,20,1, 1,1,3,23,0
```

DChanDesc (D Channel Identifier)

Description: The **DChanDesc** parameter is an ISDN parameter that identifies which trunk the D-channel resides for this B-set. This parameter is ignored for T1 CAS, clear channel, and Dialogic® Global Call protocols.

Values: 1 to 16

Guidelines: For example, on a board with four T1 ISDN lines, **DChanDesc** is set as follows:

```
defineBSet=10,1,1,24, 0,1,1,1,20,1, 1,1,3,24,0
defineBSet=20,2,1,24, 0,1,1,2,20,1, 1,1,3,24,0
defineBSet=30,3,1,24, 0,1,1,3,20,1, 1,1,3,24,0
defineBSet=40,4,1,24, 0,1,1,4,20,1, 1,1,3,24,0
```

Admin (Admin)

Description: The **Admin** parameter is an arbitrary 32-bit value set by the user that is exported to the TSC_AttrAdminGroup attribute of the TSC cluster for each B channel in the set. This attribute can be used to find and/or allocate TSC clusters.

Values: 0 to 0xFFFFFFFF

Guidelines: For example, on a T1 line, **Admin** is set to a value of 20 as follows:

```
defineBSet=10,1,1,23, 0,1,1,1,20,1, 1,1,3,23,0  
defineBSet=20,2,1,23, 0,1,1,1,20,1, 1,1,3,23,0  
defineBSet=30,3,1,23, 0,1,1,1,20,1, 1,1,3,23,0  
defineBSet=40,4,1,23, 0,1,1,1,20,1, 1,1,3,23,0
```

Width (Width)

Description: The **Width** parameter specifies the number of time slots used by each B channel. Currently, only one time slot per channel is used.

Note: This **Width** should not be modified by the user.

Values: 1

Guidelines: For example, on a T1 line, **Width** is set to a value of 1 as follows:

```
defineBSet=10,1,1,23, 0,1,1,1,20,1, 1,1,3,23,0  
defineBSet=20,2,1,23, 0,1,1,1,20,1, 1,1,3,23,0  
defineBSet=30,3,1,23, 0,1,1,1,20,1, 1,1,3,23,0  
defineBSet=40,4,1,23, 0,1,1,1,20,1, 1,1,3,23,0
```

BChanId (B Channel Identifier)

Description: The **BChanId** parameter defines the initial B channel in the set to which the TSC instance is associated. It is also the channel to which the initial time slot, defined by **SlotId**, will be mapped. B channels are then sequentially mapped to time slots for a count of **Count**.

Values: The range of values varies with technology because the number of time slots varies.

- 1 to 24: T1
- 1 to 31: E1

Guidelines: For example, on a T1 board where the D channel is mapped to time slot 24 on all four lines, **BChanId** and **SlotId** are set to a value of 1 and **NumChans** is set to a value of 23. This defines 23 B channels numbered 1 to 23 mapped to time slots 1 to 23.

```
defineBSet=10,1,1,23,0,1,1,1,20,1, 1,1,3,23,0  
defineBSet=20,2,1,23,0,1,1,2,20,1, 1,1,3,23,0  
defineBSet=30,3,1,23,0,1,1,3,20,1, 1,1,3,23,0  
defineBSet=40,4,1,23,0,1,1,4,20,1, 1,1,3,23,0
```

For E1 ISDN lines that usually contain a D channel mapped to time slot 16, the mapping of channels to time slots occurs in two sets of **BChanId**, **SlotId**, **Direction** and **Count** definitions. The first set of definitions maps time slots before the D channel and the second set maps time slots after the D channel.

For example, on an E1 ISDN board with four network interfaces, where time slot 16 is used for signaling on all four lines, **BChanId** would be defined on each line as follows:

CONFIG File Parameter Reference for Dialogic® HMP Interface Boards

```
defineBSet=10,1,1,30, 0,1,1,1,20,1, 1,1,3,15, 16,17,3,15,0
defineBSet=20,2,1,30, 0,1,1,1,20,1, 1,1,3,15, 16,17,3,15,0
defineBSet=30,3,1,30, 0,1,1,1,20,1, 1,1,3,15, 16,17,3,15,0
defineBSet=40,4,1,30, 0,1,1,1,20,1, 1,1,3,15, 16,17,3,15,0
```

In this example, channels 1 to 15 are mapped to time slots 1 to 15 and channels 16 to 30 are mapped to time slots 17 to 31.

For E1 clear channel lines where the time slot 16 is not used for signaling, additional `defineBSet` commands are added to clear channel 31. Both **StartChan** and **BChanId** are set to a value of 31, **NumChans** and **Count** are set to a value of 1, and **SlotId** is set to 16 as follows:

```
defineBSet=50,1,31,1, 0,0,0,1,21,1, 31,16,3,1,0
defineBSet=60,2,31,1, 0,0,0,1,21,1, 31,16,3,1,0
defineBSet=70,3,31,1, 0,0,0,1,21,1, 31,16,3,1,0
defineBSet=80,4,31,1, 0,0,0,1,21,1, 31,16,3,1,0
```

SlotId (Slot Identifier)

Description: The **SlotId** parameter defines the logical time slot the initial B channel, defined by **BChanId**, is using. B channels are then sequentially mapped to time slots for a count of **Count**.

Values: The range of values varies with technology because the number of time slots varies.

- 1 to 24: T1
- 1 to 31: E1 ISDN
- 1 to 31: E1 clear channel

Guidelines: For E1 ISDN, the mapping of channels to time slots occurs in two sets of **BChanId**, **SlotId**, **Direction** and **Count** definitions. The first set of definitions maps the time slots before the D channel, and the second set maps the slots after the D channel.

For example, on an E1 ISDN board with four network interfaces, where time slot 16 is used for signaling on all four lines, **SlotId** for all four lines would be as follows

```
defineBSet=10,1,1,30, 0,1,1,1,20,1, 1,1,3,15, 16,17,3,15,0
defineBSet=20,2,1,30, 0,1,1,1,20,1, 1,1,3,15, 16,17,3,15,0
defineBSet=30,3,1,30, 0,1,1,1,20,1, 1,1,3,15, 16,17,3,15,0
defineBSet=40,4,1,30, 0,1,1,1,20,1, 1,1,3,15, 16,17,3,15,0
```

For all lines in this example, channels 1 to 15 are sequentially mapped to time slots 1 to 15 and channels 16 to 30 are mapped to time slots 17 to 31.

For E1 clear channel lines where time slot 16 is not used for signaling, additional `defineBSet` commands are added to clear channel 31 and to map time slot 16. Both **StartChan** and **BChanId** are set to a value of 31, **NumChans** and **Count** are set to a value of 1, and **SlotId** is set to 16 as follows:

```
defineBSet=50,1,31,1, 0,0,0,1,21,1, 31,16,3,1,0
defineBSet=60,2,31,1, 0,0,0,1,21,1, 31,16,3,1,0
defineBSet=70,3,31,1, 0,0,0,1,21,1, 31,16,3,1,0
defineBSet=80,4,31,1, 0,0,0,1,21,1, 31,16,3,1,0
```

Direction (Direction)

Description: The **Direction** parameter defines the direction in which the data can be sent: inbound, outbound, or both.

Values:

- 1: Inbound
- 2: Outbound
- 3: Both

Guidelines: For example, on an T1 line where data is transferred both inbound and outbound, **Direction** is set to a value of 3 as follows:

```
defineBSet=10,1,1,23, 0,1,1,1,20,1, 1,1,3,23,0
defineBSet=20,2,1,23, 0,1,1,2,20,1, 1,1,3,23,0
defineBSet=30,3,1,23, 0,1,1,3,20,1, 1,1,3,23,0
defineBSet=40,4,1,23, 0,1,1,4,20,1, 1,1,3,23,0
```

Count (Count)

Description: The **Count** parameter defines the number of time slots that are being mapped to B channels. This value is limited to the value of **NumChans** since only the number of channels that exist on a line can be mapped to a time slots.

Values: 1 to **NumChans**

Guidelines: For example, on a T1 line containing two network interfaces, where time slot 24 is used as a D channel on both lines, the **Count** for both lines would be as follows:

```
defineBSet=10,1,1,23, 0,1,1,1,20,1, 1,1,3,23,0
defineBSet=20,2,1,23, 0,1,1,1,20,1, 1,1,3,23,0
```

For an E1 line, **Count** is set to a value of 30 for lines that contain only B channels. For lines that contain a single D channel, the mapping of channels to time slots occurs in two sets of **BChanId**, **SlotId**, **Direction** and **Count** definitions. The first set of definitions maps the time slots before the D channel, and the second set maps the slots after the D channel. For example, on an E1 board with four network interfaces, where time slot 16 is used for signaling on all four lines, the **Count** for all four lines would be as follows:

```
defineBSet=10,1,1,30, 0,1,1,1,20,1, 1,1,3,15, 16,17,3,15,0
defineBSet=20,2,1,30, 0,1,1,1,20,1, 1,1,3,15, 16,17,3,15,0
defineBSet=30,3,1,30, 0,1,1,1,20,1, 1,1,3,15, 16,17,3,15,0
defineBSet=40,4,1,30, 0,1,1,1,20,1, 1,1,3,15, 16,17,3,15,0
```

For all lines in this example, channels 1 to 15 are mapped to time slots 1 to 15 and channels 16 to 30 are mapped to time slots 17 to 31.

For E1 clear channel lines where the time slot 16 is not used for signaling, additional **defineBSet** commands are added to clear channel 31 and to map time slot 16. **Count** is set to a value of 1 (also the value of **NumChans**) as follows:

```
defineBSet=50,1,31,1, 0,0,0,1,21,1, 31,16,3,1,0
defineBSet=60,2,31,1, 0,0,0,1,21,1, 31,16,3,1,0
defineBSet=70,3,31,1, 0,0,0,1,21,1, 31,16,3,1,0
defineBSet=80,4,31,1, 0,0,0,1,21,1, 31,16,3,1,0
```

9.10 [sigDet] Parameters

Note: The information in this section only applies to the Dialogic® DNI/601TEPHMP board.

The signal detector section of the CONFIG file may include qualification templates for positive answering machine detection (PAMD) and positive voice detection (PVD) used in call progress analysis.

A tech note was written to provide instructions for modifying the PAMD and PVD qualification template parameters on Dialogic® DM3 boards to accomplish higher successful PAMD and PVD rates. For further information about these parameters, see the tech note at <http://www.dialogic.com/support/helpweb/dxall/tnotes/legacy/2000/tn030.htm>. Although the tech note was written for Dialogic® System Software Release 5.1.1 Feature Pack 1 for Windows®, the information applies to subsequent releases.

The modified parameters have now become the default in the firmware, so it is no longer necessary to tune the PAMD and PVD parameters as explained in the tech note. Operating with these new default values should result in improved accuracy of call progress analysis on Dialogic® DM3 boards. However, although these values are the most commonly used, they may not be suitable for every application environment. If needed, the PAMD and PVD templates are still tunable, as explained in the tech note, to achieve even better results based on the individual application environment.

The default PAMD qualification template ID is 106561 (0x1a041), but other valid PAMD qualification template IDs that can be defined in the CONFIG file are:

- 106564 (0x1a044)
- 106565 (0x1a045)
- 106566 (0x1a046)
- 106567 (0x1a047)

The default PVD qualification template ID is 128193 (0x1f4c1), but other valid PVD qualification template IDs that can be defined in the CONFIG file are:

- 128194 (0x1f4c2)
- 128195 (0x1f4c3)
- 128196 (0x1f4c4)
- 128197 (0x1f4c5)

Glossary

4ESS: A T1 protocol switch primarily used for switching digital voice, but it also supports ISDN protocols.

5ESS: A T1 protocol switch used for switching digital voice and data channels, and supports both basic rate and primary rate ISDN.

AGC: Automatic Gain Control is an encoding process that attempts to maintain a constant volume during voice recording.

alternate mark inversion: See AMI.

AMI: Alternate mark inversion is a form of bipolar signaling in which each successive mark is of the opposite polarity and spaces have zero amplitude.

Automatic Gain Control: See AGC.

base protocol: The protocol implemented by the CHP component. Protocol variants are derived from this base. Compare with *protocol variant*.

B channel: An ISDN bearer channel that carries voice, fax and compressed video.

bridge controller: A component that manages the media stream connections between Dialogic® HMP Interface Boards (DNI Boards) connected to the CT Bus and Dialogic® HMP Software.

bridge device: A component on a Dialogic® HMP Interface Boards (DNI Boards) that enables media streaming between the boards connected to the CT Bus and Dialogic® HMP Software. The bridge device also provides clocking to Dialogic® HMP Software.

CAS: Channel Associated Signaling is the component responsible for managing the generation and detection of digital line signaling functions required to manage voice channels. Channel Associated Signaling also applies to a signaling method in which the signaling for that channel is directly associated with the channel.

CCS: Common Channel Signaling is the component that applies to technologies such as ISDN that use common channel signaling. Common Channel Signaling also applies, in general, to a signaling method in which the signaling for a group of channels is carried on a separate (common) channel.

CDP: Country Dependent Parameters file defining parameters necessary for configuring products to different country requirements. This file has a *.cdp* extension.

CEPT: European Conference of Postal and Telecommunications Administrations. A group of European countries organized for the purpose of setting telecommunications standards in Europe.

CFA: Carrier-Failure Alarm.

CHP: Channel Protocol is the component responsible for implementing the telephony communication protocol that is used on each network interface.

clear channel: A signaling configuration where none of the line's bandwidth is used for signaling. Clear channel signaling is the ability to access telephony channels in the system and configure them to a user defined call control protocol, or to simply leave the lines 'clear'. The resources should have access to the telephony bus for media routing purposes, as well as signal detection, signal generation, and tone generation capabilities, if desired. NFAS is an example of clear channel signaling.

clock master: The device (board) that provides timing to all other devices attached to the TDM bus. The clock master drives bit and framing clocks for all of the other boards (slaves) in the system.

cluster: A collection of component instances that share specific TDM time slots on the network interface and which therefore operate on the same media stream data. The cluster concept in the Dialogic® architecture corresponds generally but not exactly to the concept of a "group" in S.100 or to a "channel" in conventional Dialogic architectural terminology. Component instances are bound to a particular cluster and its assigned time slots in an allocation operation.

comfort noise generation (CNG): The ability to produce a background noise when there is no speech on the telephone line.

CONFIG: A text-input configuration file containing component-specific parameters. This file has a *.config* extension and is used to create an FCD file.

configuration file: See CONFIG file.

configuration file set: A set of files associated with a specific board configuration. All the files in the set have the same name, but different extensions. The set includes the CONFIG, FCD, and PCD files.

Country Dependent Parameters: See CDP.

CRC: Cyclic Redundancy Check.

CT Bus: Computer Telephony bus. A time division multiplexing communications bus that provides 4096 time slots for transmission of digital information between CT Bus products. See TDM bus.

D channel: An ISDN channel that carries signaling information.

D4: A T1 protocol switch that supports T1 robbed bit signaling and provides D4 framing, but does not support ISDN protocols.

DCM: Dialogic® Configuration Manager - a software program that allows you to configure system-level and certain board-level parameters.

DM3: An architecture on which a whole set of Dialogic® products is built. The Dialogic® DM3 architecture is open, layered, and flexible, encompassing hardware as well as software components.

DMA: Direct memory access.

DMS: A T1 protocol switch (DMS-100) for primary rate ISDN applications.

Driver property sheet: DCM property sheet that contains parameters to optimize the board's throughput by customizing certain aspects of the board's device driver.

DTD: Dial Tone Detection.

DTMF: Dual Tone Multi-Frequency. Touchtone dialing.

E&M: Two-way telephony signaling that uses an “E” (far end) lead and an “M” (near-end) lead. Signaling is accomplished by applying -48 volts DC to the leads.

encoder: The component responsible for performing an encoding process on a media stream.

FCD: Feature Configuration Description file that lists any non-default parameter settings that are necessary to configure a hardware/firmware product for a particular feature set. This file has a *.fcd* extension.

Feature Configuration Description: See FCD.

flexible routing: A routing configuration where the resource devices (voice/fax) and network interface devices are independent, which allows exporting and sharing of the resources. All resources have access to the CT Bus.

FRU: Field replaceable unit.

FXO: Foreign Exchange Office - a device at a central site that permits extending PBX services to remote sites. The FXO emulates a phone to the PBX.

FXS: Foreign Exchange Station - a device located remotely from a PBX that permits extending PBX services to remote sites. The FXS emulates a PBX to the remote phone.

ground start: A two-way, two-wire (tip and ring) signaling method similar to loop start in which the current flows in a circuit. Ground start is normally between a PBX and central office and seizure of the line is accomplished by momentarily grounding one of the circuit wires, usually the ring of the tip and ring circuit.

HDB3: A modified AMI signaling code that only applies to E1 and is used to preserve one’s density on the line.

high density bipolar three zero: See HDB3.

in-band signaling: A signaling scheme where both the data and the signaling information for the data are carried over the same channels.

instance: A component instance is an addressable unit within the software architecture; it represents a single thread of control. The system resource management and messaging services operate at the instance level. A set of component instances that make up a resource instance communicate with one another using the system messaging services. A set of component instances is usually associated with a channel of call processing.

IPVS: IP Voice Streaming

ISDN: Integrated Services Digital Network. See primary rate ISDN.

LAPD: Link Access Protocol for the D channel.

Layer 1: Physical layer of the OSI model that address the physical aspects of network access.

Layer 2: Data Link layer of the OSI model that address data transfer and routing.

Layer 3: Network layer of the OSI model that addresses line communication procedures.

LCON: See LineAdmin.

LineAdmin: Line Administration component responsible for managing line devices.

LOF: Loss of frame.

Logical property sheet: DCM property sheet that contains parameters for configuring a board's trunk interface.

LOS: Loss of signal.

loop start: A two-way, two-wire (tip and ring) signaling method in which the current used for signaling flows in a circuit (loop) between a telephone and PBX or a telephone and central office. Seizure of the line is accomplished by going off-hook which causes current to flow in a circuit (loop).

LOF: Loss of Frame.

media loads: Pre-defined, numbered sets of features supported by Dialogic® DM3 architecture boards.

MF: Multi-Frequency

Misc property sheet: DCM property sheet that contains the parameters that define the configuration file set for the board (**PCDFileName** and **FCDFileName**), as well as, system-level and miscellaneous parameters.

MLM: Load Module.

Net5: An E1 protocol switch. Net5 is a European ISDN primary rate switch.

NFAS: Non-Facility-Associated Signaling is a form of out-of-band signaling where a single ISDN primary rate D channel provides signaling and control for up to 10 ISDN primary rate lines.

NI-2: National ISDN-2. A U.S. standard software interface that can be installed on most switch types, providing maximum interoperability with ISDN lines.

NIC: Network interface card.

non-linear processing (NLP): A process used to block or suppress the residual (echo-cancelled) signal, when there is no near end speech. This process can be used with **comfort noise generation (CNG)** to replace the echo canceller output with comfort noise (background noise) when no near end speech is detected. Background noise energy estimation is used to adjust the level of comfort noise generated. This allows the speaker to listen to the same level of background noise when the non-linear processor is switched on and off due to double-talk situations or near end speech.

NTT: A T1 protocol switch (INS-Net 1500) that is used by Nippon Telephone and Telegraph (NTT) for primary rate ISDN.

on-hook: The signaling state that occurs when a handset is sitting on the phone (the phone's inactive state) and the flash hook is depressed. Compare with *off-hook*.

off-hook: The signaling state that occurs when the handset is removed from the phone and the flash hook is released. When a phone is taken off-hook it signals the central office or PBX that it needs attention, for example, to make a call or to answering an incoming call. Compare with *on-hook*.

OSI: Open Standards Interconnections. ISO-developed open standards-based framework for inter-system communications. The OSI model categorizes the communication process into seven layers. Layers 1 to 4 address network access and Layers 5 to 7 address messaging.

out-of-band signaling: A signaling scheme where the signaling is carried over channels separate from the channels carrying the data.

PAMD: Positive answering machine detection.

PBLM: Processor Boot Load Module.

PBX: Private Branch Exchange.

PCD: Product Configuration Description file that contains product or platform configuration description information. This file has a *.pcd* extension.

PCM: Pulse Code Modulation.

PDK: Protocol Development Kit.

PDK Configuration property sheet: DCM property sheet that contains parameters for assigning country dependent parameter (CDP) files to T1 trunks that use the CAS protocol or to E1 trunks that use the R2MF protocol.

Physical property sheet: DCM property sheet that contains parameters that relate to the physical aspects of the board including physically identifying the board.

PLM: Processor Load Module.

port: A logical entity that represents the point at which PCM data can flow into or out of a component instance or interface in a cluster. The port abstraction provides a high-level means of defining potential data flow paths within clusters and controlling the actual data flow using simple protocols. Ports are classified and designated in terms of data flow direction and the type of entity that provides the port.

primary D channel: the D channel that provides the signaling and control in an NFAS configuration.

primary rate ISDN: An application that uses a single channel to carry the signaling for all other channels on a line. On a T1 line, the application uses channels 1 through 23 (B channels) to carry data, digital voice, and compressed video. Channel 24 (D channel) carries the signaling for all 23 B channels. On an E1 line, the application uses channels 1 through 15 and 17 through 31 (B channels) to carry data, digital voice, and compressed video. Channel 16 (D channel) carries the signaling for all 30 B channels.

Product Configuration Description: See PCD.

property sheet: A grouping of parameters in DCM that is based on functionality.

protocol variant: A version of the base protocol that has been customized by a set of parameters. This parameter set configures a CHP component to support a particular T1 telephony protocol. Features such as wink start, DTMF DNIS and MF ANI are enabled and tuned by the parameters in a protocol variant. Compare with *base protocol*.

pulse: A temporary state change from the current signal state to a new signaling state, and then back to the original signaling state. Compare with *sequence*, *train* and *transition*.

PVD: Positive voice detection.

Q.931: Primary rate ISDN D channel signaling protocol standard. (ITU-T Recommendation I.451). The protocol defines the signaling packet, including message type and content, and allows for voice and data transfer on a single trunk.

QSIG: A T1 and E1 protocol switch. QSIG is an ISDN signaling and control protocol used for communications between two or more Private Integrated Network Exchange applications (PSS1). The signaling protocol for this standard is defined by Q.931.

R2MF: An E1 protocol switch. R2MF is an in-band common channel signaling protocol that uses channel 16 to convey the signaling for the 30 voice channels. This international signaling system is used mostly in Europe and Asia in non-ISDN applications to permit the transmission of numerical and other information relating to the called and calling subscriber lines.

RAI: Remote Alarm Indication.

Rate Adaption: Conversion of digital data into a different transfer speed (rate) and form.

recorder: The component responsible for a resource's message exchanges with the host, as well as media stream management and encoder component control functions.

red alarm: An alarm generated by the device at the receiving end of a T1 or E1 line to report a loss of signal or frame alignment (synchronization) in the signal being received (incoming data).

resource: A conceptual entity that provides a specific functionality to a host application. A resource contains a well defined interface or message set, which the host application utilizes when accessing the resource. Resource firmware consists of multiple components that run on top of the core platform software (which includes the platform-specific DM3 kernel and device driver). The Global Call resource is an example of such a resource, providing all of the features and functionality necessary for handling calls on the platform.

sequence: A set of train signals. Compare with *pulse*, *train* and *transition*.

SIT: Special Information Tones

slave: Device (board) that is not a clock master, but instead, derives its timing from the TDM bus.

system tray: In a Windows* operating system, an area of the interface (normally in the lower, right-hand corner) that contains icons, or short cuts, for launching applications.

TDM: Time division multiplexing.

TDM bus: Time division multiplexing bus. A resource sharing bus such as the SCbus or CT Bus that allows information to be transmitted and received among resources over multiple data lines.

TDM Bus Configuration property sheet: DCM property sheet that contains parameters for configuring the TDM bus.

TEI: Terminal Endpoint Identifier. TEI defines which device(s) attached to a BRI ISDN line is communicating with the CO.

Telephony Bus property sheet: (CM property sheet for setting PCM encoding method and bus type.

time division multiplex: A multiplexing scheme in which a number of low speed digital signals are incorporated onto a high speed line in a byte-interleave pattern.

train: A set of transitions from one signaling state to another in a predefined pattern (set of pulses). Compare with *pulses*, *sequence* and *transition*.

transition: A permanent state change from the current signal state to a new signaling state. Compare with *pulse*, *sequence* and *train*.

Trunk Configuration property sheet: DCM property sheet for configuring network interfaces on certain Dialogic® boards.

TS16: An E1 protocol switch. TS16 is a type of clear channel signaling which allows time slot 16 to be used for data instead of signaling.

TSC: Telephony Service Component is the component responsible for managing the B channel sets.

Version Info. DCM property sheet that contains parameters that identify control processor and signal processor kernel versions.

VAD: Voice Activity Detection.

yellow alarm: An alarm generated by the device at the receiving end of a T1 or E1 line and sent to the device at the transmitting (remote) end to signify that a red alarm condition exists at the receiving (local) end. The yellow alarm is sent to the transmitting device as long as the red alarm condition exists at the receiving end.

Index

Symbols

[0x2c] CONFIG file section 84, 89, 104
[0x3b] CONFIG file section 94
[CCS] CONFIG file section 84, 116
[CHP] CONFIG file section 84, 87, 121
[CHP] ISDN Protocol CONFIG file section 122
[decoder] CONFIG file section 101
[encoder] CONFIG file section 85
[IPVSC] CONFIG file section 97
[lineAdmin] CONFIG file section 84, 105
[NFAS] CONFIG file section 84, 86, 113
[sigDet] CONFIG file section 101, 137
[TSC] CONFIG file section 84, 88, 130
[TSC] defineBSet CONFIG file section 130

A

A Law
 encoding parameter 130
 Layer 1 Protocol 124
accessing property sheets 16
acoustic echo 42
Admin parameter 134
AdministrativeStatus parameter 64
ADPCM Layer 1 Protocol 124
AGC
 algorithm 85
alternate mark inversion (AMI) 107, 108
Answer Deglitcher parameter 128
Answer Timeout parameter 129
Answering Machine Signal parameter 129
Attached to TDM Buses parameter 71

B

B Channel Identifier parameter 134
B channel set
 defineBSet command 88
 parameters 130-136
B8ZS 107
BaseProtocol parameter 132
BChanId parameter 134
Bell zero code suppression 108

blocking pattern 121
Board monitoring frequency in seconds parameter 62
BoardEnabled parameter 62
BoardPresent parameter 63
boards
 configuration files 29
BPVS Threshold Range parameter 112
bridge controller
 modifying parameters 34
 parameters 54
 property sheet (illustrated) 20
bridge device
 modifying parameters 33
 parameters 55
 property sheet (illustrated) 19
BridgeControllerNumberOfHSIHOLDBuffers parameter 55
BridgeDeviceBHStreamCapacity parameter 58
BridgeDeviceEnabled parameter 56
BridgeDeviceHBStreamCapacity parameter 58
BridgeDeviceHMPClockMaster parameter 57
BridgeDeviceHMPClockMasterFallbackNbrResolved parameter 57
BridgeDeviceHMPClockMasterFallbackNbrUserDefined parameter 57
BridgeDeviceId parameter 56
BridgeDeviceMaxBHStreamSetting parameter 58
BridgeDeviceMaxHBStreamSetting parameter 58
BridgeDeviceMultiBridgeSynchPattern parameter 58
BridgeDeviceStatus parameter 57
BridgeDeviceType parameter 56
bus companding method
 setting for DM3 configurations 32
Busy Signal parameter 128

C

CaAnsdglPSV parameter 127
CaAnswerTimeout parameter 129
CaBusySet parameter 128
CaFaxSet parameter 129
CaHdgLoHiGI parameter 127
Call Progress Flag parameter 127
CalledNumberCount parameter 125

CalledNumberPlan parameter 125
 CalledNumberType parameter 125
 CallingNumberCount parameter 127
 CallingNumberPlan parameter 126
 CallingNumberPresentation parameter 126
 CallingNumberScreening parameter 126
 CallingNumberType parameter 126
 CallProgress parameter 127
 CaPamdId parameter 129
 CaPvdId parameter 129
 CaPvdTimeout parameter 129
 CaRingingSet parameter 128
 CAS
 configuring 84, 103
 setting signaling type 106
 CaSignalTimeout parameter 129
 CaSitSet parameter 128
 CCS
 CONFIG file section 84
 parameters 116-120
 CCS_PROTOCOL_MODE parameter 119
 CCS_SWITCH_TYPE parameter 120
 CCS_TEI_RETRY parameter 119
 CCS_TEI_STABILITY parameter 119
 CCS_TMR_302 parameter 117
 CCS_TMR_303 parameter 117
 CCS_TMR_304 parameter 118
 CCS_TMR_305 parameter 118
 CCS_TMR_308 parameter 118
 CCS_TMR_310 parameter 118
 CCS_TMR_313 parameter 119
 CECS Threshold Range parameter 113
 CFA parameters
 RAI CRC 110
 RAICRCCFAClearTime 110
 RAICRCCFADeclareTime 110
 red alarm 109, 110
 REDCFAClearedTime 110
 REDCFADecay 109
 REDCFADeclareTime 109
 yellow alarm 110
 YellowCFAClearTime 110
 YellowCFADeclareTime 110
 channel densities 23
 Channel Protocol. *See* CHP
 channel set. *See* B channel set
 channel state 121
 CHP
 CONFIG file section 84, 87
 ISDN protocol variants 122-130
 parameters 121-122
 clear channel
 See also defineBSet parameters
 setting signaling type 107
 clock fallback
 HMP 24
 clock fallback concepts 23
 clock source
 setting for H.100 and H.110 mode systems (CT Bus) 31
 clocking
 CT Bus 23
 HMP 24
 Coding parameter 107
 Comfort Noise Generation parameter 94
 comments
 CONFIG file 84
 Common Channel Signaling. *See* CCS
 Computer Name Dialog box 28
 conferencing
 AGC low threshold 95
 conferencing device, echo cancellation 47
 CONFIG file 21
 [CHP] section 87
 [encoder] section 85
 [NFAS] section 86
 [TSC] section 88
 editing 37
 formatting conventions 83
 See also configuration file sets
 configuration
 DCM property sheet parameters 35
 configuration file sets 21
 Configuration Manager
 starting 28
 configuration manager *See* DCM 15
 configuration parameters
 for digital network interface boards 103
 for HMP software 89
 connecting to a computer 28
 context sensitive help *See* *Online Help*
 Count parameter 136
 CPBKVersion parameter 81
 CPRTKVersion parameter 82
 CRC checking parameter 108
 CRC error 110
 CRC-4 multiframe 106
 CSP/voice device, echo cancellation 48

CSUMS_AGC_low_threshold parameter 95
CT Bus
 clock fallback concepts 23
 primary clock fallback 23
 setting the clock source 31
CT Bus clocking 23
CTBus parameters *See TDM Bus parameters*
CurrentState parameter 61

D

D channel backup 116
D Channel Identifier parameter 133
D4 framing 106
DCBU 116
DChanDesc parameter 133
DCM 15
 See also property sheets
 connecting to a computer 28
 main window 16
 Online Help 17
 property sheet parameters 35
 starting 28
 starting the GUI 28
DCOM 28
default settings, restoring 39
defineBSet
 command 88
 parameters 130-136
Derive NETREF Two From (User Defined) parameter 78
Derive Primary Clock From (User Defined) parameter 76
Derive Secondary Clock From (User Defined) parameter 76
Digital Data Service zero code suppression 108
digital network interface device (DTI) 104
Direction parameter 136
DisableBlock parameter 121
DisconnectTimeout parameter 123
DlgcOUI parameter 69
doDMA parameter 59
Driver property sheet 59

E

E1 framing 106
EC Enablement parameter 89, 98, 104
EC Filter Length parameter 90
EC NLP parameter 105
EC Tail Length parameter 98, 104

echo
 acoustic 42
 electrical 42
echo cancellation
 background 41
 configuring 45
 configuring examples 49
 configuring, conferencing device 47
 configuring, CSP/voice device 48
 configuring, IP media device 45, 46
 configuring, voice device 46
 features 43
 using 44
echo cancellation capabilities 23, 43
echo cancellation enablement 89
echo cancellation tap length 90, 104
Echo Canceller NLP parameter 91
ECS Threshold Range parameter 113
editing
 See CDP file, CONFIG file, SCD file
electrical echo 42
encoder
 CONFIG file section 85
Encoding (Method) parameter 130
ESF 106
extended superframe 106

F

Fax Signal parameter 129
FCD file 12
FCD files 21
 See also configuration file sets, fcdgen, PDK Configuration Utility
FCDFilename parameter 63
fcdgen utility 37
feature configuration description 12
Feature Description File. *See FCD files*
FERR Threshold Range parameter 112
formatting conventions
 CONFIG file 83
Framing Alogorithm parameter 108
framing format 106
freeOrphanOnDepletion parameter 59

G

Global Call protocols 26
 base protocol 132
Group Four Clock Rate (User Defined) parameter 73

Group Identifier parameter 115
Group One Clock Rate (User Defined) parameter 72
Group Three Clock Rate (User Defined) parameter 72
Group Two Clock Rate (User Defined) parameter 72
GroupID parameter 115
GTE zero code suppression 108

H

HDB3 107
Hello Edge parameter 127
help *See Online Help*
high density bipolar three zero 107
High Glitch parameter 127
Host Media Processing
 clocking 24

I

Inbound (Variant) parameter 132
inbound protocol variant 132
InfoTransferCap parameter 124
InfoTransferRate parameter 124
Initial Alarm State parameter 111
Initial CAS Signaling Bit Pattern parameter 111
InitialChanState (Initial Channel State) parameter 121
initializing the system 13, 38
INSTANCE_MAP parameter 117
InstanceNumber parameter 67
InterCallDelay parameter 123
IntVector parameter 68
IP media device, echo cancellation 45, 46
IRQLevel parameter 68
ISDN Protocol Mode parameter 119
ISDN protocol variants 122-130

L

L2_TRACE parameter 120
LAPD 120
Latency Mode parameter 99
latency, improving 99
Layer 2 access flag 120
Layer 2 Access Flag parameter 120
Layer 3 LAPD functionality 120
Layer1Protocol parameter 124

line
 administration 105
 configurations, ISDN protocols 122
lineAdmin
 CONFIG file section 84
line-coding 108
LineId parameter 131
Linetype parameter 106
Link Access Protocol for the D channel 120
Logical property sheet 61
LogicalID parameter 67
LOSClearedTime parameter 109
Low Glitch parameter 127

M

main window, DCM 16
maxOrphanStrmSize parameter 60
media loads 22
Media Type (User Defined) parameter 72
minimum one's density 108
Misc property sheet 61
Misc property sheet display 17
modified alternate mark inversion 107
modifying DCM parameters 17, 35
Mu Law
 encoding parameter 130
 Layer 1 Protocol 124

N

NETREF One Clock Rate (User Defined) parameter 77
NETREF One FRU (User Defined) parameter 77
NETREF Two Clock Rate (User Defined) parameter 78
NETREF Two FRU (User Defined) parameter 78
network termination protocol 120
NFAS 86
 CONFIG file section 84, 86
 groups 114
 parameters 113-116
 primary D channel 115
 standby D channel 116
 trunk assignment 115
NFAS DCBU 116
NFAS_INSTANCE_MAP parameter 114
NFAS_PrimaryIntID parameter 115
NFAS_Standby_IntID parameter 116
Non-Facility-Associated signaling. *See* NFAS
non-linear processing (NLP) 91

NotifyAddToneFreq parameter 96
NotifyAddToneLength parameter 96
NotifyAddToneLevel parameter 95
Number of B Channels parameter 132
NumChans parameter 132

O

Online Help 17
OOE Threshold Range parameter 112
OperationalStatus parameter 65
orphanageMsgLen parameter 60
orphanageMsgTimeout parameter 60
orphanStrmTableSize parameter 60
Outbound (Variant) parameter 133
outbound protocol variant 133
out-of-band signaling 116
outStrmQuantum parameter 60

P

PAMD Speed Value parameter 128
parameters
 See also property sheets, CONFIG file
 modifying DCM 17, 35
PassiveMode parameter 62
PCD file 12
PCD files 22
 See also configuration file sets
PCDFileName parameter 63
PciBusNumber parameter 67
PciID parameter 66
PciSlotNumber parameter 67
Physical property sheet 65
Physical State parameter 65
PhysicalShelf parameter 67
PhysicalSlotNumber parameter 66
PLR Maximum Latency parameter 99
PLXAddr parameter 68
PLXlength parameter 68
PnPAutoDownload parameter 65
Positive Answering Machine Detection 101, 137
Positive Voice Detection 101, 137
prerequisites to configuration 26
primary clock fallback 23
primary D channel identifier 115
Primary Instance Identifier parameter 115
Primary Lines (User Defined) parameters 74

Primary Master FRU (User Defined) parameter 75
PrimaryBoardID parameter 69
PrmMaxLatPktsTx parameter 99
PrmPlr_LatencyAlg_Audio parameter 99
PrmRxLatencyFrameInit_Audio parameter 99
ProcessTimeout(Seconds) parameter 63
product configuration description 12
Product Configuration Description file 22
property sheets
 accessing 16
 display of Misc property sheet 17
 Driver 59
 Logical 61
 Misc 61
 Physical 65
 TDM Bus Configuration 70
 Trunk Configuration 79
 Version 81
Protocol Development Kit (PDK) 84, 88, 103
protocol variants
 assigning inbound 132
 assigning outbound, 133
 ISDN 122-130
ProtocolType parameter 123

Q

Q.931 Timer 302 parameter 117
Q.931 Timer 303 parameter 117
Q.931 Timer 304 parameter 118
Q.931 Timer 305 parameter 118
Q.931 Timer 308 parameter 118
Q.931 Timer 310 parameter 118
Q.931 Timer 313 parameter 119
Q.931 timers 117-119
QSIG Master/Slave protocol 120

R

R2MF, configuring 84, 103
R4 compatibility flag 121
R4Compatibility (Flag) parameter 121
RAI signal 110
RAICRCCFClearTime parameter 110
RAICRCCFADeclareTime parameter 110
reconfiguring 13
reconfiguring the system 38
REDCFAClearedTime parameter 110
REDCFADecay parameter 109

REDCFADeclareTime parameter 109
ReplyMsgTimeout parameter 64
Resolved TDM Bus parameters 18
restoring default settings 39
Ringing Signal parameter 128
RM_ISCR (VAD Silence Compression) parameter 93
RTP Source Filter parameter 101

S

SCbus Clock Rate (User Defined) parameter 71
SCD file
 configuration file sets 21
SCR
 concepts 85
Secondary Master FRU (User Defined) parameter 76
SecondaryBoardID parameter 69
sections. CONFIG file 84
SerialNumber parameter 69
SetId parameter 131
setting the bus companding method for DM3
 configurations 32
sigDet CONFIG file section 137
Signal Timeout parameter 129
signaling
 out-of-band 116
SignalingType parameter 106
SIT detection
 ISDN protocol 128
SIT Signal parameter 128
Slot Identifier parameter 135
SlotId parameter 135
span. *See* line
SPBKVersion parameter 82
Speed Control Enablement parameter 101
SPRTKVersion parameter 82
SRAMAddr parameter 68
sramInQuantum parameter 60
SRAMlength parameter 68
sramOutQuantum parameter 61
sramOutTimer parameter 61
SRAMSize parameter 69
standby D channel identifier 116
Standby Instance Identifier parameter 116
Start Channel (StartChan) parameter 131
starting, the system or board 39
stopping, the system or board 38

Switch Type parameter 120
Symmetrical Command Response Protocol parameter 119
symmetrical data link 119
SYMMETRICAL_LINK parameter 119
system initialization 13, 38
SystemMaxBHStreams parameter 55
SystemMaxHBStreams parameter 54

T

TDM Bus Configuration property sheet 70
TDM Bus parameters 17
TDM Bus Type (Resoved/User Defined) parameter 71
TEI Retry Timer parameter 119
TEI stability timer 119
TEI Stability Timer parameter 119
terminal emulation protcol 119
timers
 Q.931 117-119
 TEI retry 119
 TEI stability 119
TraceEnable parameter 64
TraceLevel parameter 64
Trunk Configuration property sheet 79
trunk. *See* line
TSC
 CONFIG file section 84, 88
 defineBSet parameters 130-136
 parameters 130

U

UDP Port Base for Audio RTP parameter 97
UDP Port Base for Video RTP parameter 98
User Defined TDM Bus parameters 18
Using Compatibility Clocks (User Defined) parameter 73
Using NETREF One (User Defined) parameter 74
Using NETREF Two (User Defined) parameter 75
Using Primary Master (User Defined) parameters 74
Using Secondary Master (User Defined) parameters 74

V

VAD Silence Compression parameter 93
Variant Define n command 87
Version property sheet 81
Voice Detection Signal parameter 129
Voice Detection Timeout parameter 129

voice device, echo cancellation 46

W

Width parameter 134

Y

YellowCFAClearTime parameter 110

YellowCFADeclareTime parameter 110

Z

ZeroCodeSuppression parameter 108