

## Quick Configuration

### Basic Configuration

1. Configure Logical IMG
2. Configure Physical IMG
3. Configure Network Interfaces
4. Configure Facilities
5. Configure Bearer Spans
6. Configure Signaling Spans
7. Configure VoIP Spans
8. Configure Signaling
9. Configure Routing

### Basic Routing

1. Configure Channel Groups
2. Create Routing Tables (link to Channel Groups)
3. Create Route Lists (link to Route Tables)
4. Assign Routes to Channel Groups
5. Configure Digit Translation (Optional)
6. Configure Error Handling

NOTE: Arrows originate in the fields where they are originally configured, and point to fields where the value will appear in a drop-down list.

Configured Field → Populated Field

## Translation

### ClientView Translation Panes

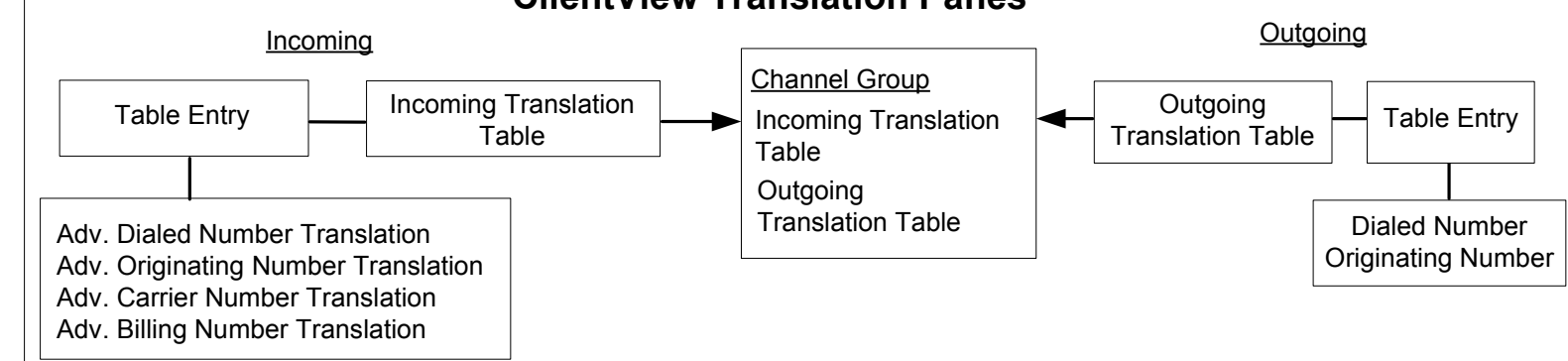

### Translation Examples

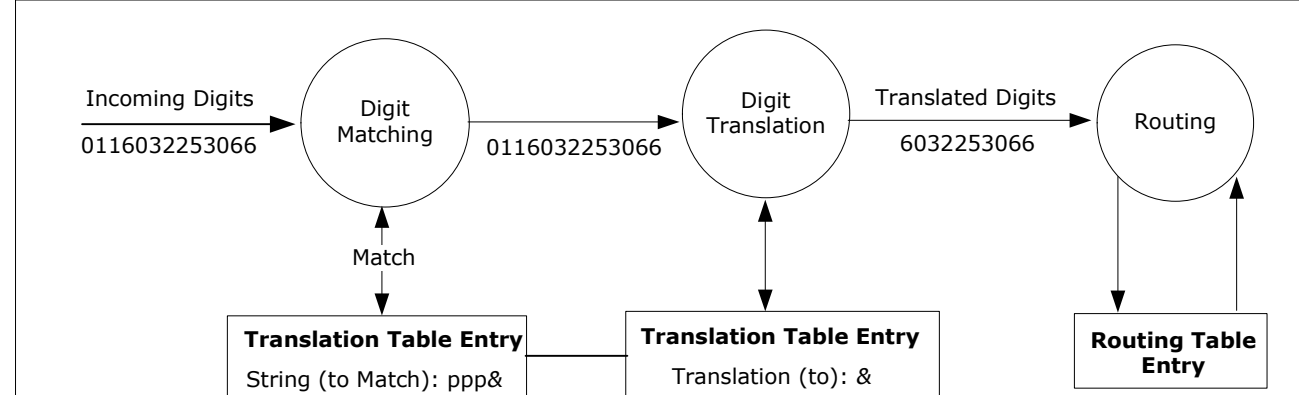
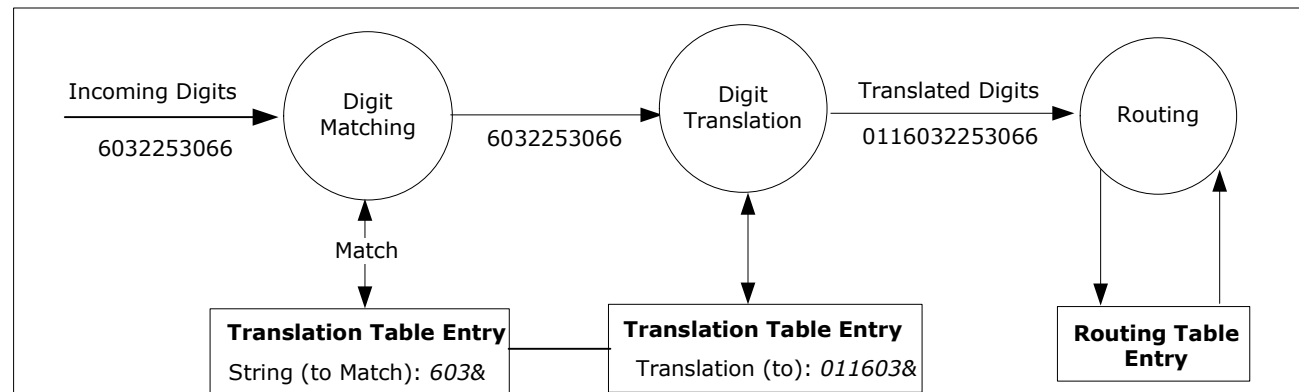
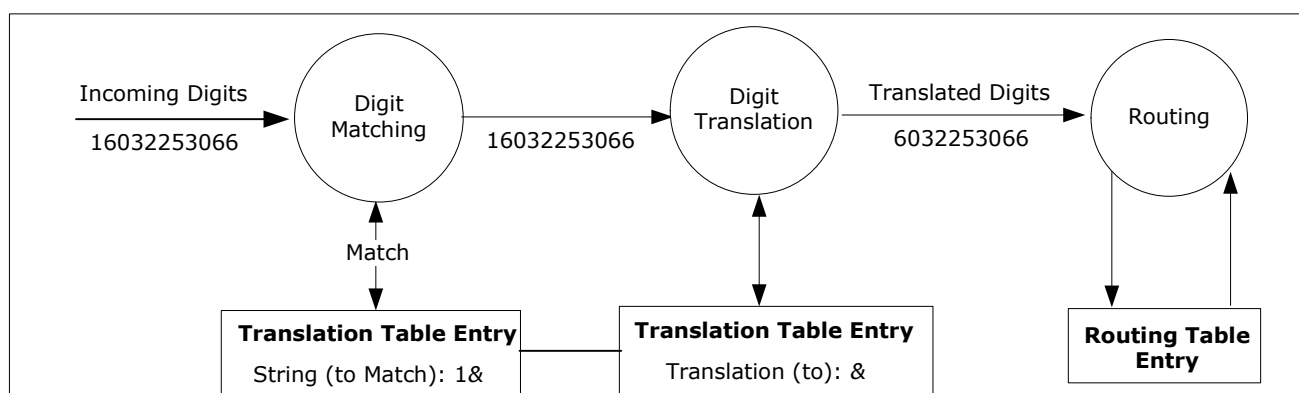
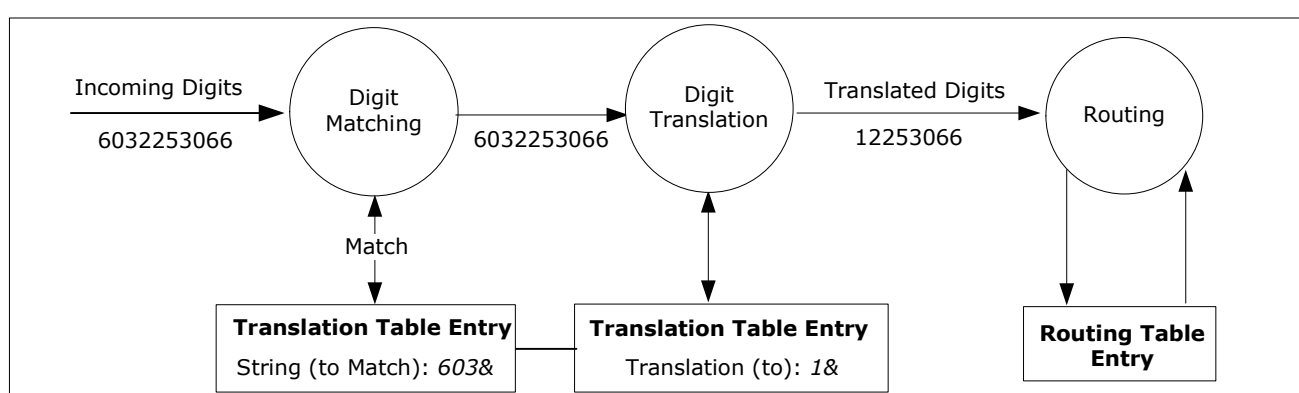

### Digit Matching Wildcards

- P -- The digits represented by a P in the match string can be either 0 or 1.
- N -- The digits represented by a N in the match string can be numerals 2 - 9.
- X, Y, Z -- The digits represented by an X, Y, or Z in the match string can be any digit. These wildcards are interchangeable. An X is generally preferred unless specifying various parts of a number. An X cannot be followed by any other digit than another X.
- V -- V represents a Null string
- & -- The ampersand (&) specifies that all remaining digits can have any value.
- # -- The pound (#) character is generally used to terminate a digit string.
- \* -- The wildcard character usually triggers a service. (\*71 Disable Call Waiting)

# Dialogic® IMG 1004 Integrated Media Gateway

## Sample Network Diagram

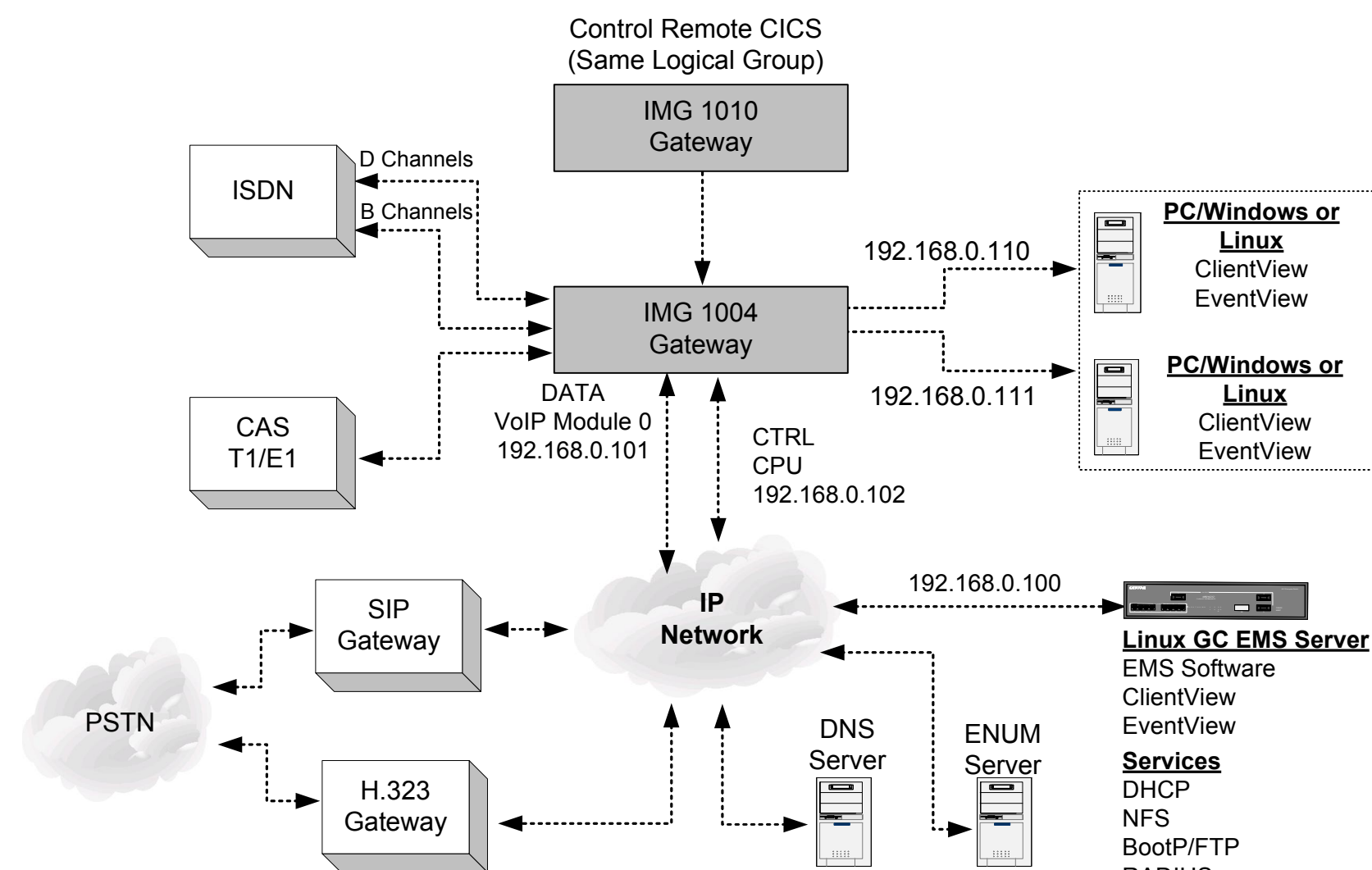

**Dialogic**  
 Making Innovation Thrive™

## Routing

### Basic Routing Process on the IMG

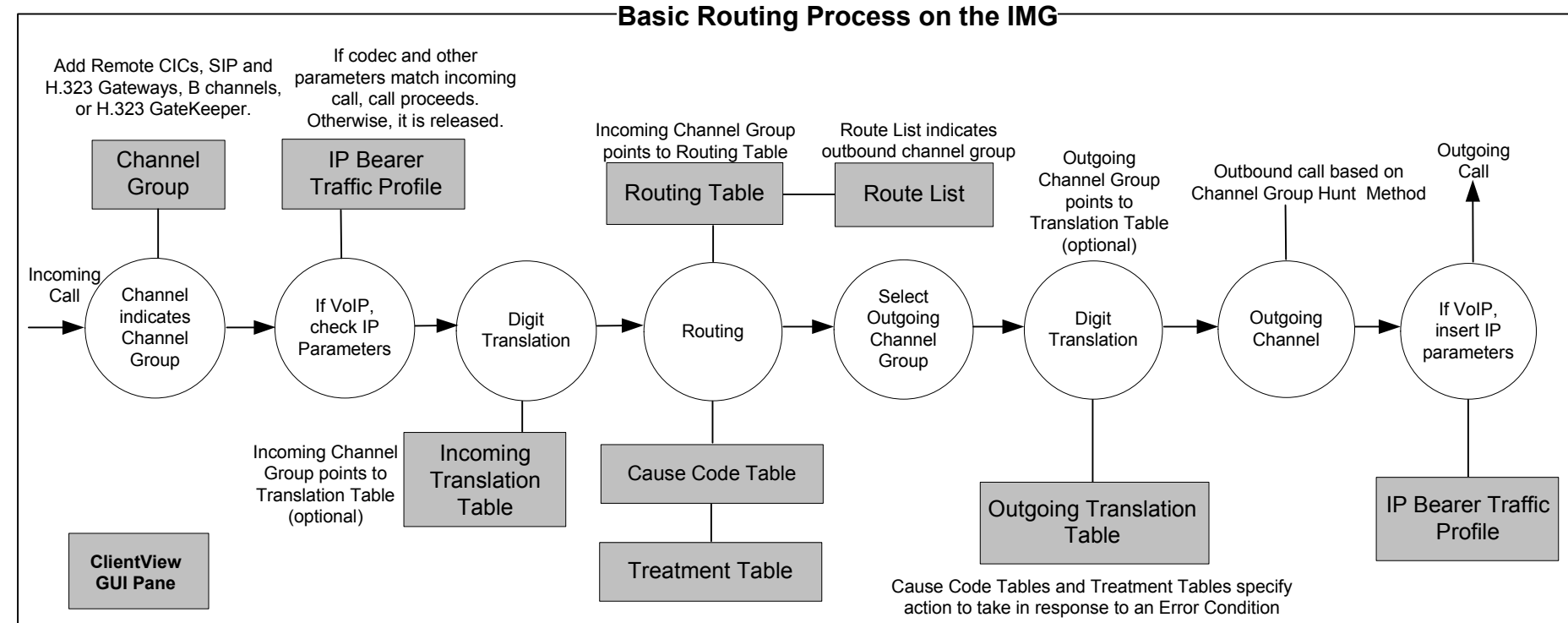

## Network Interfaces

The **Network Interfaces** section uses factory-default IP addresses to illustrate a scenario where the IMG has both the DATA and CTRL ports on the same subnet. The DATA and CTRL ports can be configured for either one or two subnets. For more information on network connections See **Network Interfaces** in the On-line Help Manual.

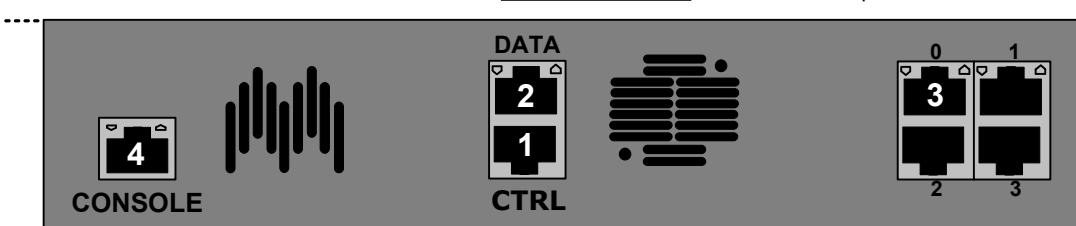

- 1 -- Connect the CTRL port to the Linux Server (GCEMS). The CTRL port is used for loading software and other services such as NFS, NTP, and DHCP. The CTRL port can also be used for VoIP signaling.
- 2 -- Connect the DATA port to the IP network. The DATA port is used for RTP and Signaling on the VoIP network.
- 3 -- Connect to T1/E1 spans.
- 4 -- Connects to a serial port and is used for CLI commands. Dialogic Technical Support Personnel may require access to this port for troubleshooting purposes.

### Guidelines

- When setting up the IMG Network Interfaces and one Network is being used the following scenarios can be accomplished.
- 1) Configure a Network Interface for each VoIP module on the Data port.
  - 2) The Ctrl port will be used for GCEMS management as well as the SIP and H.323 signaling. A network interface will not be configured for SIP and H.323 signaling when using a single subnet.
  - 3) Configure the IP address in the SIP and H.323 Signaling Pane in ClientView.
  - 4) Configure a Facility for each VoIP module.
- For H.323 or SIP signaling select the signaling IP address from the drop down list. After configuring the IP address for RTP add a facility for the VoIP module.

### One Subnet Scenario

- 1) Ctrl Port communicates with GCEMS server and handles SIP and H.323 signaling.
- 2) Control port IP address is configured through dhcpd.conf file
- 3) Data Port controls all RTP signaling
- 4) Data Port is configured under the Network Interfaces object in ClientView

Property	User Specified
Physical Interface	Ctrl Port
Logical Interface	Redundant Control
Address Type	IPv4
IP Address	0d: 192.168.0.101
Subnet	0d: 255.255.255.0
Default Gateway	0d: 192.168.0.1

Property	User Specified
Physical Interface	VoIP Module 0/Port 0
Logical Interface	Redundant Data
Address Type	IPv4
IP Address	0d: 192.168.0.102
Subnet	0d: 255.255.255.0
Default Gateway	0d: 192.168.0.1

## ClientView Objects Tree

### Configuration

#### Dialogic IMG EMS

- Logical IMG (16)
  - Certificate Database (1 per IMG)
    - Certificate Entry (16 per Certificate Database)
  - Profiles
    - Secure Profile (32 per EMS)
    - IP Bearer Profile (16 per EMS)
      - Supported Vcoders (7 per IP Bearer Profile)
      - Type of Service Configuration (1 per IP Bearer Profile)
    - T1/E1 Profile
    - SIP Gateway Profile SGP (16 per EMS)
      - SIP DTMF Support (1 per SGP)
      - SIP Headers (1 per SGP)
      - SIP From Header Tags (1 per SGP)
      - SIP Proxy (1 per SGP)
      - SIP Profile Timers (1 per SGP)
      - SIP Session Timers (1 per SGP)
      - SIP OPTIONS KeepAlive (1 per SGP)
      - SIP\_SS7 Interworking (1 per SGP)
      - SIP\_UI Support (1 per SGP)
  - Support (1 per IMG)
    - Collect Log Files
  - Signaling Variants
    - Signaling Variant (10 per EMS)
    - Variant Entry (10 per EMS)
  - CAS Signaling Variant
    - Variant Entry (10) -- PPL Tables, PPL Timers, PPL ConfigBytes
    - Inputting Parameters (4)
    - Inseize Instruction (19)
    - Outseize Instruction (19)
    - Digit Mapping (3)
    - Filter/Timer Configure (no limit)
  - SIP-T Signaling Variant
    - Variant Entry (10) -- SIP-T message format
    - Import Variant Entry File (4)
    - Export Variant Entry File (4)
  - SS7 Signaling Variant
    - Variant Entry (10) -- PPL Tables, PPL Timers, PPL ConfigBytes
    - Import Variant Entry File (4)
    - Export Variant Entry File (4)
- External Network Elements
  - DNS Servers
    - DNS Server (Shared with ENUM Server 15 Total per EMS)
  - ENUM Server Set (4 per EMS)
    - ENUM Server (3 per ENUM Server Set)
  - External Gatekeepers
    - External Gatekeeper (1 per EMS)
    - Alternate Gatekeeper (6 for each External Gatekeeper)
  - External Gateways
    - External Gateway (128 per EMS)
  - NFS Servers
    - NFS Server (8 per EMS)
  - RADIUS Servers
    - RADIUS Server (256 per EMS)
  - SNMP Managers
    - SNMP Manager (3 per EMS)

### Container Object (No Configuration Fields)

(Maximum Configurable Objects in parenthesis)

- Physical IMG (32 per Log. IMG)
  - Network Interfaces (Data and CtrlPorts)
    - Network Interface (2 per Phy. IMG)
    - Physical Port Configuration (1 per Phy. IMG)
  - Facility (IP and TDM spans)
    - TDM Spans (T1 or E1 -- 4 spans per Physical IMG)
    - Facility Wizard (Used to configure and deconfigure spans)
    - Bearer -- IP (Configuring VoIP Module)
    - Cross Connects (Can not be used as ISDN or CAS)
  - Signaling
    - H.323 Signaling (1 per Phy. IMG)
      - H.323 Timers (1 per H.323 Sig. object)
    - SIP Signaling (1 per Phy. IMG)
      - SIP Timers (1 per SIP Sig. object)
      - SIP Network Element (15 per SIP Gateway)
      - SIP Virtual Address (2 per SIP Sig. Object)
      - SIP T Entity (4 per SIP Sig. object) Selectable when SIP-T is enabled
    - ISDN Signaling (1 per Phy. IMG)
      - ISDN D Channels
      - ISDN D Channel (T1 - 24 or E1 - 32 per Physical IMG)
      - ISDN Timers (1 per ISDN Sig. object)
  - Raw API Cmds
    - Raw API Cmd (1 per Phy. IMG)
    - Raw API Cmd (Used for sending RAW API)
  - Media
    - Media Module (1 per Phy. IMG)
    - Media DSP (1 per Phy. IMG)
  - Timing Synchronization Priority List (Arrange Timing Priorities.)
  - Call Tracing (1 per Physical IMG)
  - DNS Client (1 per Phy. IMG)
  - Licensing Info (1 per Phy. IMG)
  - Radius Client (1 per Phy. IMG)
  - SNMP Agent (1 per Phy. IMG)
  - Telnet Client (1 per Phy. IMG)
  - FTP Server (1 per Phy. IMG)
  - Time Zone Setting (UTC Offset) (1 per Physical IMG)
  - Clear Software (1 per Phy. IMG)
  - Configuration Wizard (1 per Phy. IMG)
  - Download RAW API file (1 per Phy. IMG)
  - Graceful Out of Service (1 per Phy. IMG)

- Physical IMG ID:2
- Physical IMG ID:3
- Physical IMG ID:3

### Routing Configuration

- Channel Groups (256 per EMS)
  - Signaling Type: ISDN
    - ISDN Group (T1 - 4 / E1 - 4 Spans per Channel Group)
      - ISDN Circuits (128 per ISDN Group)
      - Bearer Capabilities Override (1 per ISDN Group)
      - ISDN Parameter Filter (1 per ISDN Group)
      - ISDN Interworking Redirection (1 per ISDN Group)
  - Signaling Type: SS7
    - ISUP Group (512 per SS7 Channel Group)
      - Circuits (128 per Channel Group)
      - FCI Override (1 per ISUP Group)
      - BCI Override (1 per ISUP Group)
      - Location Override (1 per ISUP Group)
      - TMR USI Override (1 per ISUP Group)
      - SS7 Parameter Filter (1 per ISUP Group)
      - SIP ISUP IW (1 per ISUP Group)
      - ITU Location Number Assertion (1 per ISUP Group)
  - Signaling Type: H.323
    - IP Network Element (1 per H.323 Channel Group)
  - Signaling Type: SIP
    - IP Network Element (1 per SIP Channel Group)
  - Signaling Type: CAS
    - Channel Associated Signaling (1 per CAS Channel Group)
    - CAS Circuits (no limit)
- Incoming Translation Table
  - Translation Table (20 total incoming and outgoing)
    - Translation Entry (200 per Translation Table)
  - Advanced Dialed/Oriinating/Billing/Carrier Number (1 per Translation Entry each)
- Routing Tables
  - Route Table (66 Tot. RT/CC/TOD Tables per EMS)
    - Route Entry (5,000 per Route Table)
- Time of Day Tables
  - Time of Day Table (66 Tot. RT/CC/TOD Tables per EMS)
    - Time of Day Entry (5,000 per TOD Table)
- Route Lists
  - Route List (254 per EMS)
    - Channel Group in Route List Entry (20 per Route List)
- Outgoing Translation Table
  - Translation Table (20 per EMS - total in and out)
    - Translation Entry (200 per Translation Table)
    - Advanced Dialed/Oriinating/Billing/Carrier Number (1 per Translation Entry each)
- Cause Code Tables
  - Cause Code Entry (66 Total RT/CC/TOD Tables per EMS)
    - Cause Code Entry (5,000 per CC Table)
- Service Routing Tables
  - Service Route Table (66 Total RT/CC/TOD Tables per EMS) → Service Route Entry
    - Service TOD Table
    - Service TOD Entry
- Vocabulary Index Files
  - Vocabulary Index File (1 per EMS)
    - Vocabulary Index Entry (1,024 per VIF)
- Treatment Tables
  - Treatment Table (6 in addition to the default table)
    - Treatment Entry (256 per Treatment Table)
    - Treatment Phrase (15 per Treatment Table)
- IP Traffic Management
  - IP Traffic Management Entry (128 per EMS)