

**Dialogic<sup>®</sup> Diva<sup>®</sup> Media Board**

Installation Guide

**Dialogic<sup>®</sup> Diva<sup>®</sup> Karten**

Installationsanleitung

**Adaptadores Dialogic<sup>®</sup> Diva<sup>®</sup>**

Guía de Instalación

# Dialogic® Diva® Media Board Installation Guide

Seventeenth Edition (September 2009)

203-195-17

## Copyright and Legal Notice

Copyright © 1999-2009 Dialogic Corporation. All Rights Reserved. You may not reproduce this document in whole or in part without permission in writing from Dialogic Corporation at the address provided below.

All contents of this document are furnished for informational use only and are subject to change without notice and do not represent a commitment on the part of Dialogic Corporation or its subsidiaries ("Dialogic"). Reasonable effort is made to ensure the accuracy of the information contained in the document. However, Dialogic does not warrant the accuracy of this information and cannot accept responsibility for errors, inaccuracies or omissions that may be contained in this document.

INFORMATION IN THIS DOCUMENT IS PROVIDED IN CONNECTION WITH DIALOGIC® PRODUCTS. NO LICENSE, EXPRESS OR IMPLIED, BY ESTOPPEL OR OTHERWISE, TO ANY INTELLECTUAL PROPERTY RIGHTS IS GRANTED BY THIS DOCUMENT. EXCEPT AS PROVIDED IN A SIGNED AGREEMENT BETWEEN YOU AND DIALOGIC, DIALOGIC ASSUMES NO LIABILITY WHATSOEVER, AND DIALOGIC DISCLAIMS ANY EXPRESS OR IMPLIED WARRANTY, RELATING TO SALE AND/OR USE OF DIALOGIC PRODUCTS INCLUDING LIABILITY OR WARRANTIES RELATING TO FITNESS FOR A PARTICULAR PURPOSE, MERCHANTABILITY, OR INFRINGEMENT OF ANY INTELLECTUAL PROPERTY RIGHT OF A THIRD PARTY.

Dialogic products are not intended for use in medical, life saving, life sustaining, critical control or safety systems, or in nuclear facility applications.

Due to differing national regulations and approval requirements, certain Dialogic products may be suitable for use only in specific countries, and thus may not function properly in other countries. You are responsible for ensuring that your use of such products occurs only in the countries where such use is suitable. For information on specific products, contact Dialogic Corporation at the address indicated below or on the web at [www.dialogic.com](http://www.dialogic.com).

It is possible that the use or implementation of any one of the concepts, applications, or ideas described in this document, in marketing collateral produced by or on web pages maintained by Dialogic may infringe one or more patents or other intellectual property rights owned by third parties. Dialogic does not provide any intellectual property licenses with the sale of Dialogic products other than a license to use such product in accordance with intellectual property owned or validly licensed by Dialogic and no such licenses are provided except pursuant to a signed agreement with Dialogic. More detailed information about such intellectual property is available from Dialogic's legal department at 9800 Cavendish Blvd., 5th Floor, Montreal, Quebec, Canada H4M 2V9. Dialogic encourages all users of its products to procure all necessary intellectual property licenses required to implement any concepts or applications and does not condone or encourage any intellectual property infringement and disclaims any responsibility related thereto. These intellectual property licenses may differ from country to country and it is the responsibility of those who develop the concepts or applications to be aware of and comply with different national license requirements.

Dialogic, Dialogic Pro, Brooktrout, Diva, Cantata, SnowShore, Eicon, Eicon Networks, NMS Communications, NMS (stylized), Eiconcard, SIPControl, Diva ISDN, TruFax, Exnet, EXS, SwitchKit, N20, Making Innovation Thrive, Connecting to Growth, Video is the New Voice, Fusion, Vision, PacketMedia, NaturalAccess, NaturalCallControl, NaturalConference, NaturalFax and Shiva, among others as well as related logos, are either registered trademarks or trademarks of Dialogic Corporation or its subsidiaries. Dialogic's trademarks may be used publicly only with permission from Dialogic. Such permission may only be granted by Dialogic's legal department at 9800 Cavendish Blvd.,

5th Floor, Montreal, Quebec, Canada H4M 2V9. Any authorized use of Dialogic's trademarks will be subject to full respect of the trademark guidelines published by Dialogic from time to time and any use of Dialogic's trademarks requires proper acknowledgement.

Microsoft, Windows, Windows Vista, and Windows Server are registered trademarks of Microsoft Corporation in the United States and/or other countries. Other names of actual companies and products mentioned herein are the trademarks of their respective owners.

## Dialogic Corporation License Agreement for Use of Software

This is an Agreement between you, the Company, and your Affiliates (referred to in some instances as "You" and in other instances as "Company") and all Your Authorized Users and Dialogic Corporation ("Dialogic").

YOU SHOULD CAREFULLY READ THE SOFTWARE LICENSE AGREEMENT ("AGREEMENT") ON THIS SEALED PACKAGE BEFORE OPENING THE PACKAGE. BY OPENING THE PACKAGE, YOU ACCEPT THE TERMS AND CONDITIONS OF THIS AGREEMENT. IF YOU DO NOT AGREE WITH OR ARE UNWILLING TO ACCEPT THESE

TERMS AND CONDITIONS, YOU MAY RETURN THE PACKAGE IN UNOPENED "AS NEW" CONDITION (INCLUDING ALL DOCUMENTATION AND BINDERS OR OTHER CONTAINERS) FOR A FULL REFUND. BY DOWNLOADING, INSTALLING, COPYING OR OTHERWISE USING THE ENCLOSED SOFTWARE ("PROGRAM"), YOU FURTHER AGREE AND ACKNOWLEDGE THAT YOU HAVE READ THIS AGREEMENT AND UNDERSTAND IT, AND THAT BY TAKING ANY ONE OR MORE OF SUCH STEPS/ACTIONS YOU AGREE TO BE BOUND BY SUCH TERMS AND CONDITIONS. DIALOGIC IS UNWILLING TO LICENSE THE SOFTWARE TO YOU IF YOU DO NOT ACCEPT AND AGREE TO BE BOUND BY THE TERMS AND CONDITIONS OF THIS AGREEMENT.

### Intellectual Property

The enclosed Software ("Program") and all accompanying documentation are individually and collectively owned by Dialogic Corporation ("Dialogic"), its subsidiaries and/or its suppliers and are protected by all applicable intellectual property laws and international treaty provisions. Therefore, You and Your Authorized Users must treat the Program and documentation like any other material so protected, except as expressly permitted in this Agreement. In particular, but without limitation, You acknowledge that the Program and its accompanying documentation constitute valuable intellectual property rights, including without limitation trade secrets and copyrights, and confidential information of Dialogic. The Program and all programs developed thereunder and all copies thereof (including without limitation translations, compilations, partial copies with modifications and updated works) are proprietary to Dialogic and title to all applicable copyrights, trade secrets, patents and other intellectual property rights therein remains in Dialogic, its subsidiaries, and/or its suppliers. Except as expressly permitted in this Agreement, You shall not sell, transfer, publish, disclose, display or otherwise make available the Program or copies thereof to others. You agree to secure and protect the Program, its accompanying documentation and copies thereof in a manner consistent with the maintenance of Dialogic's rights therein and to take appropriate action by instruction or agreement with Your employees and/or consultants who are permitted access to the Program to satisfy Your obligations hereunder. Violation of any provision of this paragraph shall be the basis for immediate termination of this Agreement. Because unauthorized use or transfer of the Software or documentation may diminish substantially the value of such materials and irrevocably harm Dialogic, if You breach the provisions of this Section of this Agreement, Dialogic shall be entitled to injunctive and/or other equitable relief, in addition to other remedies afforded by law, to prevent a breach of this Section of this Agreement.

### Grant of License

Subject to the terms and conditions of this Agreement Dialogic grants to You a non-exclusive, personal, non-transferable license to use the Program in object code form only and solely in accordance with the following terms and conditions:

- You may make, install and use only one (1) copy of the Program on a single-user computer, file server, or on a workstation of a local area network, and only in conjunction with a legally acquired Dialogic® hardware or software product You may also make one copy solely for backup or archive purposes;
- The primary Authorized User on the computer on which the Program is installed may make a second copy for his/her exclusive use on either a home or portable computer;

- You may copy the Program into any machine readable or printed form for backup or modification purposes in support of Your use of one copy of the Program;
- You may distribute the Program in object code only and only as part of, or integrated by You into, a computer system that (i) contains a Dialogic hardware product, (ii) includes a substantial amount of other software and/or hardware manufactured or marketed by You and (iii) is marketed and sublicensed to an end user for the end user's own internal use in the regular course of business (a "Licensed System");
- Each end user to whom a Licensed System is distributed must agree to license terms with respect to the Program that are at least as protective of Dialogic's rights in the Program as those set forth in this Agreement;
- You shall receive one (1) Program master disk, and shall be solely responsible for copying the Program into the Licensed Systems and for warranting the physical media on which it is copied
- You may make one (1) copy of the documentation accompanying the Program, provided that all copyright notices contained within the documentation are retained;
- You may modify the Program and/or merge it into another Program for Your use in one computer; (any portion of this Program will continue to be subject to the terms and conditions of this Agreement);
- You may transfer the Program, documentation and the license to another eligible party within Your Company if the other party agrees to accept the terms and conditions of this Agreement. If You transfer the Program and documentation, You must at the same time either transfer all copies whether in printed or machine readable form to the same party or destroy any copies not transferred; this includes all modifications and portions of the Program contained in or merged into other Programs;
- You shall not remove, and each copy of the Program shall contain, the same copyright, proprietary, patent and/or other applicable intellectual property or other ownership notices, plus any restricted rights legends that appear in the Program and/or this Agreement and, if You copy the Program onto media to which a label may be attached, You shall attach a label to the media that includes all such notices and legends that appear on the Program master disk and envelope;
- You may not rent or lease the Program. You may not reverse engineer, decompile or disassemble the Program. Except as is strictly necessary for You to integrate the Program with other software and/or hardware to produce the Licensed Systems, You shall not copy, modify or reproduce the Program or documentation in any way. You shall use Your best efforts to ensure that any user of the Program does not reverse engineer, decompile or disassemble the Program to derive a source code equivalent of the Program;
- If You transfer possession of any copy, modification or merged portion of the Program or documentation to another party in any way other than as expressly permitted in this Agreement, this license is immediately and automatically terminated;
- The Program may be used only in conjunction with Dialogic hardware;
- The Program shall not be exported or re-exported in violation of any export provisions of the United States or any other applicable jurisdiction.

### **Upgrades**

If the Program is provided as an upgrade and the upgrade is an upgrade from another product licensed to You and Your Authorized Users by Dialogic, the upgrade is governed by the license agreement earlier provided with that software product package and the present Agreement does not grant You additional license(s). If You and Your Authorized Users choose to upgrade this Program or the product used together with the Program and such upgrade requires the license of additional software (whether a charge is associated with such software or not), the license agreement associated with such additional software shall govern the license of such additional software to the exclusion of this Agreement.

## **Term**

The Agreement is effective until terminated. You may terminate it at any time by notifying Dialogic and/or by destroying the Program and all accompanying documentation together with all copies, modifications and merged portions in any form. The Agreement will also terminate automatically upon the occurrence or lack of occurrence of certain terms and/or conditions set forth in this Agreement, or if You fail to comply with any term or condition of this Agreement. You agree that upon any such termination You shall destroy or return to Dialogic the Program and all accompanying documentation supplied by Dialogic, together with any and all copies, modifications and merged portions in any form. All provisions of this Agreement relating to disclaimers of warranties, limitation of liability, remedies, or damages, and licensor's proprietary rights shall survive termination.

## **Limited Warranty**

Dialogic solely warrants the media on which the Program is furnished to You to be free from defects in materials and workmanship under normal use for a period of ninety (90) days from the date of purchase by You as evidenced by a copy of Your receipt. If such a defect appears within the warranty period, You may return the defective media to Dialogic for replacement without charge provided Dialogic, in good faith, determines that it was defective in materials or workmanship. Replacement is Your sole remedy with respect to such a defect. Dialogic offers no warranty for Your reproduction of the Program. This Limited Warranty is void if failure of the Program has resulted from accident, misuse, abuse or misapplication.

## **Disclaimers, Limitations of Liability and Customer Remedies**

Except as set forth in the "Limited Warranty" Section of this Agreement, the Program and accompanying documentation are provided to You "as is." Neither Dialogic, its subsidiaries, its suppliers, nor its licensor(s) (if any) warrants that the Program will meet Your requirements or that its use will be uninterrupted or error-free. Except as set forth in the "Limited Warranty" Section, EACH OF DIALOGIC, ITS SUBSIDIARIES, ITS SUPPLIERS AND ITS LICENSOR(S) (IF ANY) DISCLAIMS ANY AND ALL REPRESENTATIONS AND WARRANTIES, EXPRESS OR IMPLIED, WITH RESPECT TO THE PROGRAM AND ACCOMPANYING DOCUMENTATION, INCLUDING BUT NOT LIMITED TO THE IMPLIED WARRANTIES OF NON-INFRINGEMENT, MERCHANTABILITY, FITNESS FOR A PARTICULAR PURPOSE, OR AGAINST LATENT DEFECTS. Except as set forth in the "Limited Warranty" Section, neither Dialogic, its subsidiaries, its suppliers, nor its licensor(s) (if any) shall have any liability to You or any third party for any claim, loss or damage of any kind, including but not limited to lost business profits, business interruption, loss of information, or other pecuniary loss and indirect, punitive, incidental, economic, consequential or special damages, arising out of or in connection with this Agreement and/or the use, inability to use the Program and/or the Program's performance or inability to perform nor from or in connection with the Program's accompanying documentation, or any data or equipment related thereto or used in connection therewith. In no event shall Dialogic's, its subsidiaries', its suppliers' or its licensor(s)'s liability for damages, whether arising out of contract, negligence, warranty, or patent or copyright infringement, exceed the fees You paid for the Program. No representation or warranty regarding the Program may be made without Dialogic's, its subsidiaries', its suppliers', or its licensor(s)'s (if any) prior written consent, and any warranty or representation made by You or Your customers regarding the Program shall not constitute an obligation of Dialogic, its subsidiaries, its suppliers, or other licensor(s) (if any). This limited warranty gives You specific legal rights. You may have other rights, which may vary from jurisdiction to jurisdiction. Also, as some jurisdictions do not allow the exclusion or limitation for certain damages, some of the above limitations may not apply to You.

## **Right to Audit**

If this Program is licensed for use in a Company, Your Company and You individually and collectively agree to keep all usual and proper records and books of accounts and all usual proper entries relating to each installation of the Program during the term of this Agreement and for a period of three (3) years thereafter. During this period, Dialogic may cause an audit to be made of the applicable records in order to verify Your compliance with this Agreement and prompt adjustment shall be made to compensate for any errors

or omissions disclosed by such audit. Any such audit shall be conducted by an independent certified public accountant selected by Dialogic and shall be conducted during the regular business hours at Your offices and in such a manner as not to interfere with Your normal business activities. Any such audit shall be paid for by Dialogic unless material discrepancies are disclosed. For such purposes, "material discrepancies" shall mean three percent (3%) or more of the Authorized Users within the Company. If material discrepancies are disclosed,

Your Company agrees to pay Dialogic for the costs associated with the audit as well as the license fees for the additional licensed channels or additional authorized users. In no event shall audits be made more frequently than semi-annually unless the immediately preceding audit disclosed a material discrepancy.

### **Supplementary Software**

Any Supplementary Software provided with the Program and/or referred to in this Agreement is provided "as is" with no warranty of any kind.

### **Miscellaneous**

You acknowledge that You have read this Agreement, that You understand it, and that You agree to be bound by its terms and conditions, and You further agree that this is the complete and exclusive statement of the Agreement between the Dialogic and You ("the Parties"), which supersedes and merges all prior proposals, understandings and all other agreements, oral and written, between the Parties relating to the Program. You agree to indemnify and hold harmless Dialogic and its subsidiaries, affiliates, suppliers, officers, directors and employees from and against any claim, injury, loss or expense, including reasonable attorneys' fees, arising out of (i) Your failure to comply with the provisions of this Agreement, or (ii) any other wrongful conduct by or on behalf of You. This Agreement applies to all updates, future releases, modifications and portions of the Program contained in or merged into other programs. This Agreement may not be modified or altered except by written instrument duly executed by Dialogic. No action, regardless of form, arising out of this Agreement or the use of the Program may be brought by You more than two (2) years after the cause of action has first arisen. Except as provided herein, neither this Agreement nor any rights granted are assignable or transferable, and any assignment or transfer will be null and void. If You authorize any other person to copy the Program, You shall obligate that person in writing to comply with all conditions of this Agreement. Dialogic shall have the right to collect from You its reasonable expenses incurred in enforcing this agreement, including attorney's fees. The waiver or failure of Dialogic to exercise in any respect any right provided for herein shall not be deemed a waiver of any further right hereunder. All rights and remedies, whether conferred hereunder or by any other instrument or law, will be cumulative and may be exercised singularly or concurrently. Failure by either Dialogic or You to enforce any term or condition of the Agreement will not be deemed a waiver of future enforcement of that or any other term or conditions. The terms and conditions stated herein are declared to be severable. Should any term(s) or condition(s) of this Agreement be held to be invalid or unenforceable the validity, construction and enforceability of the remaining terms and conditions of this Agreement shall not be affected. It is expressly agreed that Dialogic and You are acting as independent contractors under this Agreement. These terms and conditions will prevail notwithstanding any different, conflicting or additional terms and conditions that may appear on any other agreement between Dialogic and You. Deviations from these terms and conditions are not valid unless agreed to in writing in advance by an authorized representative of Dialogic. Any notices sent to Dialogic under this Agreement must be sent by registered mail or courier to the attention of Dialogic's legal department at the address below or such other address as may be listed on [www.dialogic.com](http://www.dialogic.com) from time to time as being Dialogic's Montreal headquarters.

### **U.S. Government Restricted Rights**

The Program and all accompanying documentation are provided with RESTRICTED RIGHTS. Use, duplication or disclosure by the U.S. Government is subject to restrictions as set forth in subparagraph (c)(1)(iii) of The Rights in Technical Data and Computer

Software clause at DFARS 252.227-7013 or subparagraph (c) (1) and (2) of the Commercial Computer Software-Restricted Rights at 48 CFR52.227-19, both as applicable.

**Governing Law**

Any and all claims arising under this Agreement shall be construed and controlled by the laws in force in the Province of Quebec, Canada, excluding its principles of conflict of laws and the United Nations Convention on Contracts for the Sale of Goods. Dialogic is not obligated under any other agreements unless they are in writing and signed by an authorized representative of Dialogic.

**Contractor/ manufacturer is:**

Dialogic CORPORATION.

9800 Cavendish Blvd., Montreal, Quebec, Canada H4M 2V9

This Agreement has been drafted in English at the express wish of the parties. Ce contrat a été rédigé en anglais à la demande expresse des parties.



## Hardware Limited Warranty

**Warranty for Hardware Products:** Dialogic Corporation or its subsidiary that originally sold the hardware product to you ("Dialogic") warrants to the original purchaser ("Purchaser") of this hardware product ("Product"), that at the time of delivery the Product supplied hereunder will be free from defects in material and workmanship. This warranty is for the standard period for such Product set out on Dialogic's website at <http://www.dialogic.com/warranties> at the date of purchase, provided the Product remains unmodified, is operated under normal and proper conditions in accordance with its published specifications and documentation, and the system is not opened by unauthorized personnel. The warranty is also void if the defect has resulted from accident, misuse, abuse or misapplication. Any Product which becomes defective during the warranty period and is returned by Purchaser to Dialogic's Authorized Service Center shipping prepaid with a Return Material Authorization (RMA) number (which must be obtained from Dialogic before any return) within thirty (30) days after discovery of the defect, with a written description of the defect, will be repaired or replaced at Dialogic's option. Dialogic will not accept C.O.D. shipments. Dialogic reserves the right to refuse to repair or replace any Product which shows signs of abuse, misuse, neglect or has been altered in any way, including but not limited to Products which have been (i) used in environments which exceed operating tolerances such as supplied voltages and signals or (ii) stored under improper temperature or humidity conditions or (iii) used with equipment, software or interfacing not furnished by Dialogic or (iv) improperly packaged or shipped or (v) harmed by Purchaser or its agents' fault or negligence or (vi) repaired or modified without Dialogic's prior written consent. Purchaser must exercise proper electrostatic discharge (ESD) precautions and pack the Product and the other returned diagnostic information **in the original Dialogic packaging, including the antistatic bag/container and an ESD foam-filled cardboard box. Purchaser may void the warranty if the Product is improperly packaged or shipped.** Dialogic will bear the cost to return the repaired or replaced Product to the location specified on the Return Material Authorization (RMA) form by a method it chooses. If the Purchaser desires a specific form of conveyance, the Purchaser must bear the cost of shipment. All risk of loss shall be with the Purchaser during any and all shipments of the Product. Duties and import fees are the responsibility of the Purchaser.

**Additional Exclusions:** Dialogic will have no obligation to make repairs or replacements to the Product due to causes beyond the control of Dialogic, including, but not limited to, power or air conditioning failure, acts of God, improper interface with other units, or malfunction of any equipment or software used with the Dialogic Product(s). If Dialogic is requested and agrees to make repairs or replacements necessitated by any such causes, Purchaser will pay for such service or replacement at Dialogic's then prevailing rates.

**No Other Warranties:** DIALOGIC DISCLAIMS AND PURCHASER WAIVES ALL OTHER WARRANTIES, EITHER EXPRESS OR IMPLIED, INCLUDING BUT NOT LIMITED TO IMPLIED WARRANTIES OF MERCHANTABILITY, NON-INFRINGEMENT AND FITNESS FOR A PARTICULAR PURPOSE AND ANY WARRANTY AGAINST LATENT DEFECTS, WITH RESPECT TO ANY DIALOGIC PRODUCT.

**No Liability for Damages:** IN NO EVENT SHALL DIALOGIC OR ITS SUPPLIERS BE LIABLE FOR ANY DAMAGES WHATSOEVER (INCLUDING, WITHOUT LIMITATION, DAMAGES FOR LOSS OF PROFITS, INTERRUPTION OF ACTIVITIES, LOSS OF INFORMATION OR OTHER PECUNIARY LOSS AND DIRECT OR INDIRECT, CONSEQUENTIAL, INCIDENTAL, ECONOMIC OR PUNITIVE DAMAGES) ARISING OUT OF THE USE OF OR INABILITY TO USE ANY DIALOGIC PRODUCT.

**Limitation of Liability:** DIALOGIC'S MAXIMUM CUMULATIVE LIABILITY SHALL BE LIMITED TO THE AMOUNTS ACTUALLY PAID BY PURCHASER TO DIALOGIC FOR THE SPECIFIC PRODUCT BEING THE OBJECT OF THE CLAIM. PURCHASER RELEASES DIALOGIC FROM ALL AMOUNTS IN EXCESS OF THE LIMITATION. PURCHASER ACKNOWLEDGES THAT THIS CONDITION IS ESSENTIAL AND THAT DIALOGIC WOULD NOT SUPPLY TO PURCHASER IF IT WERE NOT INCLUDED. THIS WARRANTY EXPRESSLY DOES NOT APPLY TO ANYONE OTHER THAN PURCHASER.

---

# Contents

## English

Copyright and Legal Notice .....	1
Dialogic Corporation License Agreement for Use of Software .....	3
Hardware Limited Warranty .....	8
Supported Dialogic® Diva® Media Boards .....	13
Supported Operating Systems.....	15
Dialogic® Diva® Online Documentation .....	15
General Safety Instructions .....	16
Line Provisioning and Configuration for Dialogic® Diva® PRI Media Boards.....	18
Ordering Your ISDN PRI or T1 Line in North America .....	18
Ordering Your Analog Line in North America.....	21
Before You Start .....	22
Installation.....	23
Troubleshooting .....	38
Technical Specifications.....	44
International Regulatory Information .....	54
Suppliers Declaration of Conformity .....	68
Customer Service.....	83

## Deutsch

Unterstützte Dialogic® Diva® Karten.....	85
Unterstützte Betriebssysteme .....	87
Dialogic® Diva® Online-Dokumentation.....	87
Allgemeine Sicherheitshinweise .....	88
Vorbereitungen .....	90

---

Installation .....	91
Problembehandlung .....	106
Technische Daten.....	112
Zulassungsinformationen .....	122
Kundendienst .....	123
Umweltinformationen für Ihr Dialogic® Produkt.....	125

## **Español**

Adaptadores Dialogic® Diva® disponibles .....	127
Sistemas Operativos.....	129
Dialogic® Diva® Documentación Online .....	129
Instrucciones de Seguridad .....	130
Preparativos.....	132
Instalación .....	133
Problemas y Soluciones .....	147
Datos Técnicos .....	153
Soporte Técnico.....	164
Información Medioambiental Para Su Producto .....	166

## Dialogic® Diva® Media Board Installation Guide

The Dialogic® Diva® Media Boards provide high-speed digital or analog connections to support a variety of network applications. This installation guide describes how to physically install and connect your Diva Media Board, provides information about technical specifications, and gives an overview of the available online documentation.

## Supported Dialogic® Diva® Media Boards

The Dialogic® Diva® product range comprises the following Diva Media Boards:

### Dialogic® Diva® BRI Media Boards

Diva BRI Media Boards are high-performance, partly active PC-based server boards that provide digital, analog, and GSM connections over an ISDN line.

#### **Diva BRI PCI:**

- Diva BRI-CTI
- Diva BRI-2FX
- Diva BRI-2
- Diva 4BRI-8
- Diva UM-BRI-2
- Diva UM-4BRI-8

#### **Diva BRI PCIE:**

- Diva BRI-2 PCIE
- Diva 4BRI-8 PCIE
- Diva UM-BRI-2 PCIE
- Diva UM-4BRI-8 PCIE

### Dialogic® Diva® PRI, E1, and T1 Media Boards

These Diva Media Boards are active server boards that provide both digital and analog connectivity for the ISDN Primary Rate Interface (PRI), E1, and T1 lines. The Diva multiport Media Boards provide rich media processing capabilities for up to 120 voice channels over E1 interfaces, or up to 96 voice channels over T1 interfaces.

#### **Diva PRI PCI:**

- Diva PRI/E1/T1-CTI
- Diva PRI/E1/T1-8
- Diva PRI/T1-24
- Diva PRI/E1-30

#### **Diva V-PRI PCI:**

- Diva V-PRI/T1-24
- Diva V-PRI/E1-30

#### **Diva V-xPRI PCI:**

- Diva V-2PRI/T1-48
- Diva V-2PRI/E1-60
- Diva V-4PRI/T1-96
- Diva V-4PRI/E1-120

**Diva PRI PCI:**

- Diva UM-PRI/T1-24
- Diva UM-PRI/E1-30

**Notes for Diva V-xPRI PCIe Media Boards:**

- The abbreviation "HS" stands for half size. For exact measurements, see page 50. These Diva Media Boards may be approved in some countries using the family equipment type "VPRIHS".
- The abbreviation "FS" stands for full size. For exact measurements, see page 51. These Diva Media Boards may be approved in some countries using the family equipment type "VPRIFS" and the model names "Diva V-4PRIFS" and "Diva V-8PRIFS".

**Diva PRI PCIe:**

- Diva PRI/E1/T1-CTI PCIe
- Diva PRI/T1-24 PCIe
- Diva PRI/E1-30 PCIe
- Diva UM-PRI/T1-24 PCIe
- Diva UM-PRI/E1-30 PCIe

**Diva V-PRI PCIe:**

- Diva V-PRI/T1-24 PCIe
- Diva V-PRI/E1-30 PCIe

**Diva V-xPRI PCIe:**

- Diva V-1PRI/E1/T1-30 PCIe HS
- Diva V-2PRI/E1/T1-60 PCIe HS
- Diva V-4PRI/E1/T1-120 PCIe HS
- Diva V-4PRI/E1/T1-120 PCIe FS
- Diva V-8PRI/E1/T1-240 PCIe FS

**Dialogic® Diva® Analog Media Boards**

Diva Analog Media Boards offer standard RJ10 or RJ45 interfaces to connect to public and private switching systems. Since they provide high-performance media processing functions, they can enhance the overall system performance and lower implementation costs.

**Diva Analog PCI:**

- Diva Analog-2
- Diva Analog-4
- Diva Analog-8
- Diva UM-Analog-2

**Diva Analog PCIe:**

- Diva Analog-2 PCIe
- Diva Analog-4 PCIe
- Diva Analog-8 PCIe
- Diva UM-Analog-2 PCIe

**Diva Analog PCI:**

- Diva UM-Analog-4
- Diva UM-Analog-8

**Diva Analog PCIE:**

- Diva UM-Analog-4 PCIE
- Diva UM-Analog-8 PCIE

**Dialogic® Diva® softIP Board**

The virtual Dialogic® Diva® softIP board is a middleware that enables existing voice and fax applications to be fully integrated into Voice over IP networks, by using the Ethernet board (NIC) of the PC. To the application Diva softIP looks like a Diva Media board. Technically speaking, the Diva softIP software is comparable to an ISDN media board providing functions such as voice and fax transmission, DTMF tones and supplementary services as well as conferencing between ISDN and VoIP connections.

- virtual Diva softIP 2.2 board

**Supported Operating Systems**

Dialogic® Diva® Media Boards support the following operating systems:

- Linux (most of the known kernels and distributions)
- Microsoft® Windows® 7
- Microsoft® Windows Server® 2008
- Microsoft® Windows Vista®
- Microsoft® Windows Server® 2003
- Microsoft® Windows® XP

**Note:** You can install your Dialogic® Diva® BRI and UM-BRI Media Board on a computer with Microsoft® Windows® Small Business Server (SBS).

**Dialogic® Diva® Online Documentation**

Diva online documentation is available with the drivers of the Dialogic® Diva® System Release software or on the Dialogic web site at <http://www.dialogic.com/manuals/default.htm>. The online documentation describes the installation of the Diva System Release software, the feature set and the configuration, diagnostics, and test tools.

## General Safety Instructions

Use the following safety instructions to help ensure your own personal safety and to help protect your computer, your Dialogic® Diva® Media Board, and your working environment from potential damage.

### **WARNING All Dialogic® Diva® Media Boards**



All computers that have Diva Media Boards installed must comply with the country specific safety regulations, such as CE or FCC, to avoid serious personal injuries and damage to your computer, your Diva Media Board, or both.

Before you install your Diva Media Board or remove the cover from your computer for any reason, disconnect the ISDN or analog cable from the ISDN, analog network, E1, or T1 line, to avoid personal injuries and damage to your computer, your Diva Media Board, or both.

Proper installation of the Diva Media Board requires that it is screwed to the metal backplate of the PC. This ensures proper grounding that is necessary for your safety.

Never install telephone jacks in wet locations.

Never touch non-insulated telephone wires or terminals unless the telephone line has been disconnected at the network interface.

Use caution when installing or modifying telephone lines.

Telephone companies report that electrical surges, typically lightning transients, are very destructive to customer terminal equipment connected to AC power sources. The use of a surge arrester on the AC line is recommended.

### **Dialogic® Diva® BRI and PRI Media Boards, except Dialogic® Diva® V-xPRI PCIe HS and V-xPRI PCIe FS Media Boards**

PRI and BRI signals can have telephone network voltages (TNV). Therefore, ISDN BRI, ISDN PRI, E1, and T1 lines should be installed and maintained by service personnel only. It may be hazardous if your computer is not properly plugged in and grounded. This applies particularly to users in North America and Australia.

### **Dialogic® Diva® V-xPRI PCIe HS and V-xPRI PCIe FS Media Boards**

Diva V-xPRI PCIe HS and V-xPRI PCIe FS Media Boards are safety extra-low voltage (SELV) products with no TNV connections.



**WARNING****Dialogic® Diva® V-2PRI PCI, V-4PRI PCI, V-4PRI PCIe FS and V-8PRI PCIe FS Media Boards**

Diva V-2PRI PCI and V-4PRI PCI Media Boards may need approximately 20 Watts of power.

Diva V-4PRI PCIe FS and V-8PRI PCIe FS Media Boards may need approximately 24 Watts of power.

If you have installed several of these Diva Media Boards in your system, make sure that the power supply will not be overloaded when you install your Diva Media Board, to avoid personal injuries and damage to your computer, your Diva Media Board, or both.

Make also sure that your PC provides sufficient cooling to avoid damage on your Diva Media Board.

**IMPORTANT Dialogic® Diva® BRI and PRI Media Boards**

The Diva BRI and PRI Media Boards have been tested and found to comply with the Electromagnetic compatibility, Safety, and Network connection regulations within the European Union, North America, and other major territories. Read the regulatory information in [International Regulatory Information](#) on page 54 before installing and using your Diva Media Board.

Cables for PRI interface ports shall be shielded.

**Dialogic® Diva® PRI PCIe, V-xPRI PCI, and V-xPRI PCIe Media Boards**

Diva PRI PCIe, V-xPRI PCI, and V-xPRI PCIe Media Boards should only be operated within the permitted temperature range - see page 44 for more information. If the temperature is exceeded, a trace file with the temperature information will be created.

**Dialogic® Diva® Analog Media Boards**

Use only certified telecommunications cables with No. 26 AWG (American Wire Gauge) or higher with this equipment to ensure proper functioning of the Diva Media Board.

## Line Provisioning and Configuration for Dialogic® Diva® PRI Media Boards

During the software installation, select the switch type as specified by your service provider, e.g., Euro-ISDN (ETSI). This will set all line parameters to a default value that is the most common value for the respective switch type.

In some countries the parameter value is different than the default. For the Euro-ISDN (ETSI) switch type for example, the CRC 4 mode is normally on, so the default will set the parameter **CRC 4 Mode** to **ON**. However, the CRC setting needs to be **OFF** for Energis lines in the UK and Telecom Eireann lines in the Republic of Ireland. Normally, lines in France, Belgium, and the Netherlands are also provisioned with the CRC 4 mode **OFF**.

Please make sure that you configure the value as required by your service provider. For detailed information, see the Dialogic® Diva® Configuration Manager Online Help (DSMain.chm) for Windows® operating systems and the Dialogic® Diva® System Release LIN Reference Guide for Linux.

**Note:** Your service provider will deactivate your line if you connect to it with wrong settings. Always contact your service provider to ask for your line to be reactivated before testing with new settings.

## Ordering Your ISDN PRI or T1 Line in North America

This chapter will assist you in ordering an ISDN PRI or a T1 line for your Dialogic® Diva® PRI Media Board. It provides recommended settings for a number of the configuration settings on Diva PRI Media Boards. You should specify these settings when you order your line from your service provider.

### Line types

Diva PRI Media Boards can be configured to support an ISDN PRI line or a T1 line.

### ISDN PRI

In North America and Japan, an ISDN PRI line typically supports 23 B-channels and one D-channel. PRI configurations are used to receive multiple, simultaneous ISDN calls from analog-modem and digital-services dial-in traffic. Another common use of ISDN PRI is to connect a PBX (Private Branch Exchange) to a central office switch.

## Channelized T1 (robbed-bit signaling)

Robbed-bit signaling, which uses bits from specified frames in the user data channel for signaling, fits into the in-band signaling category. In this scenario, bits are "robbed" from each channel for signaling purposes, as opposed to ISDN PRI (out-of-band signaling) which dedicates a specific channel (D-channel) to signaling.

## Connecting to a PBX

In some installations, the PRI or T1 line is connected to a PBX instead of the Dialogic® Diva® PRI Media Board. In these cases, you must correctly configure the PBX to communicate with the Diva PRI Media Board.

## Provisioning an ISDN PRI connection

This section explains how to order an ISDN PRI line for your Dialogic® Diva® PRI Media Board.

### What to order

Specify the following requirements when you place your order:

- 23 B-channels + 1 D-channel
- D-channel on channel 24 (timeslot 24). Do not order NFAS (non-facility associated signaling service), which enables you to use channel 24 as a data-carrying B-channel.
- Layer 1 line code is B8ZS with ESF (Extended SuperFraming).
- Data rate of 1.544 Mbps
- 64 kbps clear channel service, which ensures that calls will not be routed over 56 kbps channels.
- Companding type is  $\mu$ -law
- A CSU is not required (the Dialogic® Diva® Media Board supplies the function of the CSU internally). However, you can connect to a CSU if present.
- A DSU is not required (the Dialogic® Diva® Media Board supplies the function of the DSU internally).

**Note:** Dialogic® Diva® V-1PRI PCIe HS, V-2PRI PCIe HS, V-4PRI PCIe HS, V-4PRI PCIe FS, and V-8PRI PCIe FS Media Boards do not supply the function of the CSU or DSU internally. You need to purchase it from an independent distributor.

- The T1 interface number must be 0.
- The D-channel must be specified as the terminal endpoint identifier (TEI) 0.
- If the switch type is AT&T/Lucent, request that allocation of channels for incoming calls is in descending order, high to low (23 to 1).

## Information to obtain when ordering

Obtain the following information when you place your order. You will need this information to properly configure your Dialogic® Diva® PRI Media Board.

- The type of ISDN switch your line is connected to.
- Directory or phone number assigned to the PRI line.
- Line build out setting (LBO). Only if you are going to use the Diva Media Board's on-board CSU.

**Note:** Dialogic® Diva® V-1PRI PCIe HS, V-2PRI PCIe HS, V-4PRI PCIe HS, V-4PRI PCIe FS, and V-8PRI PCIe FS Media Boards do not supply the function of the CSU or DSU internally. You need to purchase it from an independent distributor.

- Number of DNIS (Dialed Number Identification Service) digits provided by your service provider. Normally, you can choose between four, seven, or ten digits.

## Provisioning a channelized T1 connection (robbed-bit)

This section explains how to order a T1 line that uses robbed-bit signaling for your Dialogic® Diva® PRI Media Board.

### What to order

Specify the following when you place your order:

- Switched T1 service for 56 kbps voice calls
- No multichannel services (switchtec 384/H0 or 1536/H11)
- Extended SuperFrame (ESF)
- B8ZS line encoding
- Wink Start E&M signaling
- DTMF dialing
- Answer supervision required for outgoing calls
- A CSU is not required (the Dialogic® Diva® Media Board supplies the function of the CSU internally). However, you can connect to a CSU if present.
- A DSU is not required (the Dialogic® Diva® Media Board supplies the function of the DSU internally).

**Note:** Dialogic® Diva® V-1PRI PCIe HS, V-2PRI PCIe HS, V-4PRI PCIe HS, V-4PRI PCIe FS, and V-8PRI PCIe FS Media Boards do not supply the function of the CSU or DSU internally. You need to purchase it from an independent distributor.

## Information to obtain when ordering

Obtain the following information when you place your order. You will need this information to properly configure your Dialogic® Diva® PRI Media Board.

- The type of ISDN switch your line is connected to.
- Directory number assigned to the T1 line.
- Number of DNIS (Dialed Number Identification Service) digits provided by your service provider. Normally, you can choose between four, seven, or ten digits.

## Ordering Your Analog Line in North America

This chapter will assist you in ordering an analog line for your Dialogic® Diva® Analog Media Board.

### Line types

Diva Analog Media Boards can be configured to support a standard analog line. Specify the following requirements when you place your order:

- Standard analog line
- Loop start line
- Dial type: Diva Analog Media Boards support tone and pulse dialing. It is recommended to specify tone as the dial type.

### Connecting to a PBX

In most installations, the analog line is connected to a PBX instead of the Diva Analog Media Board. If this is the case and you wish to do DTMF collection through the PBX, you need to configure the sequence on the PBX as follows:

- Ring voltage
- 500 ms pause
- Routing through DTMF
- 500 ms pause
- Open the call path

## Before You Start

Before you start, make sure you have the items you need to install your Dialogic® Diva® Media Board and the corresponding software.

Item	Description
Computer	<p>Your computer must have:</p> <ul style="list-style-type: none"> <li>• a free PCI slot for PCI bus boards (for Dialogic® Diva® V-2PRI und V-4PRI Media Boards according to PCI 2.2)</li> <li>• a free PCIe x1 or x4 slot, 1.0a compliant for PCIe bus boards. Other slot sizes, e.g., x8, x16 can be used if supported by the BIOS and the operating system.</li> </ul> <p><b>Note:</b> The x4 slot is only necessary for Dialogic® Diva® V-4PRI PCIe FS and V-8PRI PCIe FS Media Boards</p> <ul style="list-style-type: none"> <li>• an installed operating system: Linux, Microsoft® Windows® 7 Microsoft® Windows Server® 2008, Microsoft® Windows Vista®, Microsoft® Windows Server® 2003, Microsoft® Windows® XP</li> <li>• at least 15 MB of free hard-disk space for the software</li> </ul>
Dialogic® Diva® ISDN Media Board package	<p>This includes:</p> <ul style="list-style-type: none"> <li>• Dialogic® Diva® ISDN Media Board</li> <li>• Diva BRI Media Boards only: cable(s) needed to connect to your ISDN line</li> <li>• Dialogic® Diva® V-8PRI PCIe FS Media Board: four cables with dongle</li> <li>• Dialogic® Diva® Media Board Installation Guide</li> </ul>
Dialogic® Diva® Analog Media Board package	<p>This includes:</p> <ul style="list-style-type: none"> <li>• Diva Analog Media Board</li> <li>• cables to connect to your analog line</li> <li>• Dialogic® Diva® Analog-8 Media Boards: four cables with dongle</li> <li>• Diva Media Board Installation Guide</li> </ul>
Cables	<p>For Dialogic® Diva® PRI Media Boards, the RJ45 cables are not part of the package and need to be ordered from an independent distributor.</p>
CSU/DSU	<p>Dialogic® Diva® V-1PRI PCIe HS, V-2PRI PCIe HS, V-4PRI PCIe HS, V-4PRI PCIe FS, and V-8PRI PCIe FS Media Boards do not supply the function of the CSU or DSU internally. You need to purchase it from an independent distributor and connect it externally. See <a href="#">Connect your Dialogic® Diva® PRI Media Board</a> on page 28 for more information.</p>

Item	Description
ISDN Basic Rate Interface (BRI), Primary Rate Interface (PRI), channelized E1 or T1 interface, or analog interface	The lines are installed by your service provider. Make sure that you get the appropriate line(s) for your Dialogic® Diva® Media Board.
Information about your line	Your service provider has to provide the following information: <ul style="list-style-type: none"> <li>• switch type: This usually depends on your geographic location. Common switch types include Euro-ISDN DSS1 (used in Europe), ITR6 (used mainly in PBXs in Germany), NI-1 (used in North America), and 5ESS (used in North America).</li> <li>• phone numbers for each E1, T1, or analog line</li> <li>• <i>North America only:</i> Service Profile Identifiers (SPIDs) for each ISDN BRI line</li> </ul>

## Installation

This chapter will assist you in installing your Dialogic® Diva® Media Board and connecting it to your ISDN BRI, ISDN PRI, E1, T1, or analog line.

You need to complete the following three procedures to use your Diva Media Board properly:

- (A) Insert your Diva Media Board into your computer as described below.
- (B) Connect your Diva Media Board as described on page 25.
- (C) Install your Dialogic® Diva® System Release software as described on page 37.

**Note:** You may need to consult your computer's manual during the installation of your Diva Media Board.

### (A) Insert your Diva Media Board into your computer

1. For your safety, disconnect all technical and peripheral devices and all energy sources from the computer.
2. Drain static electricity from your body by touching the metal chassis (the unpainted metal at the back of your computer).
3. Remove the ISDN cable, if present, and the power cord from your computer.
4. Remove the cover of the computer as described in your computer's manual.
5. Locate a PCI or PCIe slot in your computer.
6. If there is a metal plate at the end of the slot, remove the screw or loosen the clip and remove the metal plate. Keep the screw for fastening your Diva Media Board.

- If your Diva Media Board comes with a retainer, and space does not permit the use of the retainer, simply remove it before you insert the Diva Media Board. The retainer is only an installation aid, and does not add functionality to the board.

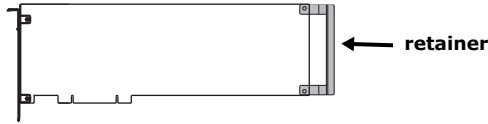

- Before you insert your Diva Media Board, read the following safety instruction:

**CAUTION:** To avoid damaging your hardware, insert the Diva Media Board only into a PCI or PCIe slot, according to your board type. Inserting the Diva Media Board into any other type of slot can damage your board, your computer, or both.



Firmly insert the Diva Media Board into the selected slot. Make sure that the Diva board does not touch the CPU, memory modules, or other parts on the motherboard.

**Note:** Additionally to the PCI bus, Dialogic® Diva® V-2PRI PCI and V-4PRI PCI Media Boards have a H.100 bus on the board. The H.100 bus is not operational; therefore, only insert the Diva Media Board with the PCI bus into the computer.

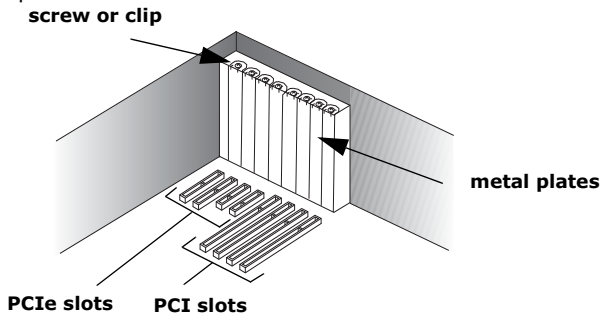

- Firmly secure the Diva Media Board with the screw or clip.

**WARNING:** For your safety, make sure that the Diva Media Board's bracket is properly secured to the PC's chassis by fastening the Diva Media Board with the screw or clip. This will ensure proper grounding and avoid personal injuries and damage to your computer, your Diva board, or both.



- Replace the cover of the computer as described in your computer's manual.



## (B) Connect your Dialogic® Diva® Media Board

How you connect your Diva Media Board depends on the type of Diva Media Board you have:

- To connect a Dialogic® Diva® BRI Media Board, follow the instructions below.
- To connect a Dialogic® Diva® PRI Media Board, follow the instructions on page 28.
- To connect a Dialogic® Diva® Analog Media Board, follow the instructions on page 33.

### Connect your Dialogic® Diva® BRI Media Board

**Note:** If you plan to use your Diva BRI Media Board as network termination for back-to-back operation or connection to PBX networks, go to page 27.

*In Europe and most countries worldwide:*

In Europe as well as most countries except North America and Japan, connect your ISDN line with a standard ISDN cable.

**1. Take the cable included with the Diva Media Board and plug one end into the board.**

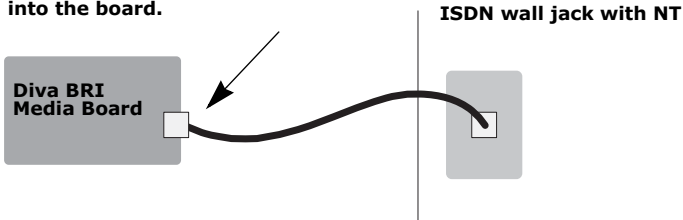

**2. Plug the other end into the ISDN wall jack.**

*In North America, Japan, and some other countries:*

In North America, Japan, and a few other countries, you need an NT1 to connect your ISDN line. Make sure that a power supply is available for the NT1 of this line. Usually, a PBX is installed in the same area as the NT1 and the service provider can use the power supply of the PBX for the ISDN line as well. If this is not the case, you have to order a combo device from your service provider. This device consists of an installation rack into which an NT1 module and a power supply module is mounted.

1. Take the cable included with the Diva Media Board and plug one end into the board.

3. Take the cable included with the NT1 and plug one end into the ISDN wall jack.

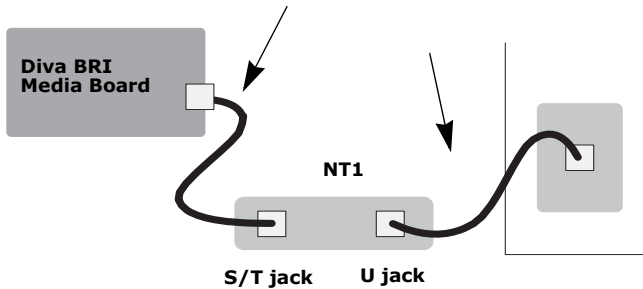

2. Plug the other end into the S/T jack.

4. Plug the other end into the U jack.

**Note for Dialogic® Diva® 4BRI Media Boards:**

The Diva 4BRI Media Boards have four ports for connecting to four separate ISDN BRI lines. Connect all four cables as described above. You can use any port; typically, you must specify the port number during software configuration. The port numbers are shown below. The diagram is oriented with the edge connector pointing downwards.



### Connecting Dialogic® Diva® BRI Media Boards in NT mode:

The Dialogic® Diva® System Release software enables you to configure Diva BRI Media Boards as network termination (NT). This means your Diva Media Board can serve as an NT for PBXs, for example, when coupling PBXs with the Q.SIG protocol, and it can be used for back-to-back operation.

When connecting the Diva Media Board to a PBX that acts as terminal equipment and therefore requires an NT to provide a clocking signal, configure the Diva board as an NT. Wire the Diva board to the PBX as shown in the diagram below by applying the appropriate assignment to the PBX connectors. Use the required termination resistors.

When using two Diva Media Boards in back-to-back operation, configure one Diva board as an NT and the other one as terminal equipment (TE). Connect the boards using a crossover cable. The cable wiring must correspond to the diagram below and the cable must have the required termination resistors.

Pole (contact) assignments for 8-pole connections (plugs and jacks):

Pins on RJ45	TE Side		Wiring	NT Side	
	Wire	Signals		Wire	Signals
1	not used				
2	not used				
3	2a	TX +		1a	TX +
4	1a	RX +		2a	RX +
5	1b	RX -		2b	RX -
6	2b	TX -		1b	TX -
7	not used				
8	not used				

Termination resistors  
100 Ohm, 5%

**Note:** Looking at the RJ45 connector with the exposed connector pins facing you, the pins are numbered from 1 to 8 from left to right (as shown below).

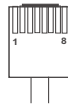

## Connect your Dialogic® Diva® PRI Media Board

**Note:** Diva PRI Media Boards, except Dialogic® Diva® V-xPRI PCIe HS/FS Media Boards, have a built-in CSU (Channel Service Unit) to protect the Diva Media Boards from damage due to power surges. However, you can also use an external CSU, which allows you to test your ISDN, E1, or T1 line.

The cable you use to connect the Diva PRI Media Board depends on how you want to apply the Diva Media Board:

- RJ45 to RJ45 for connection to an ISDN PRI, E1, or T1 line with an RJ45 jack or for connection as network termination to a PBX.
- RJ45 to open-ended cables for connection to your ISDN PRI, E1, or T1 line with open-ended wire connections or for back-to-back connection.

*If the ISDN PRI or T1 line is installed with an RJ45 jack:*

Use an RJ45 to RJ45 cable:

Div a PRI Media Board	Signals	RJ45 Terminal
Pin 1	Receive + (RX +)	Pin 1
Pin 2	Receive - (RX -)	Pin 2
Pin 4	Transmit + (TX +)	Pin 4
Pin 5	Transmit - (TX -)	Pin 5
shielded plug	overall shielded	shielded plug

**Note:** For E1 Mode with 75 Ohm impedance, use an external 75 Ohm Balun Adapter. You can purchase such an adapter from specialized stores.

How you connect your Dialogic® Diva® PRI Media Board depends on the board type:

- To connect any Diva PRI Media Board, except the Dialogic® Diva® V-8PRI PCIe FS Media Board, follow the instructions on page 29.
- To connect Diva V-8PRI PCIe FS Media Board, follow the instructions on page 30.

**Any Diva PRI Media Board, except the Diva V-8PRI Media Board:**

Connect any Diva PRI Media Board, except the Diva V-8PRI Media Board as shown in this graphic:

1. Take the cable and plug one end into the board.

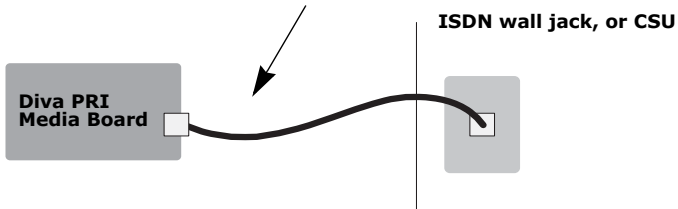

2. Plug the other end into the wall jack or the CSU.

**Note for Dialogic® Diva® V-2PRI PCI and V-4PRI PCI Media Boards:**

Diva V-2PRI PCI Media Boards have two ports and Diva V-4PRI PCI Media Boards have four ports for connecting to two or four separate ISDN PRI, E1, or T1 lines. Connect all two or four cables as described above. You can use any port; typically, you must specify the port number during software configuration. The port numbers are shown below. The diagram is oriented with the edge connector pointing downwards.

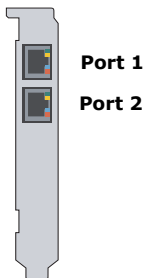
**Diva V-2PRI Media Board****Diva V-4PRI Media Board**

**Note for Dialogic® Diva® V-1PRI PCIe HS, Diva V-2PRI PCIe HS, Diva V-4PRI PCIe HS, and Diva V-4PRI PCIe FS Media Boards:**

Diva V-xPRI PCIe HS and the Diva V-4PRI PCIe FS Media Boards have four ports. The "x" or the "4" stand for the activated ports; that means one port is activated on the Diva V-1PRI HS Media Board, two ports on the Diva V-2PRI HS Media Board, and four ports on the Diva V-4PRI PCIe HS and Diva V-4PRI PCIe FS Media Board. You can use only the activated ports, which are shown in the graphic below. The diagram is oriented with the edge connector pointing downwards. Typically, you must specify the port number during software configuration. Connect the cables as described above.

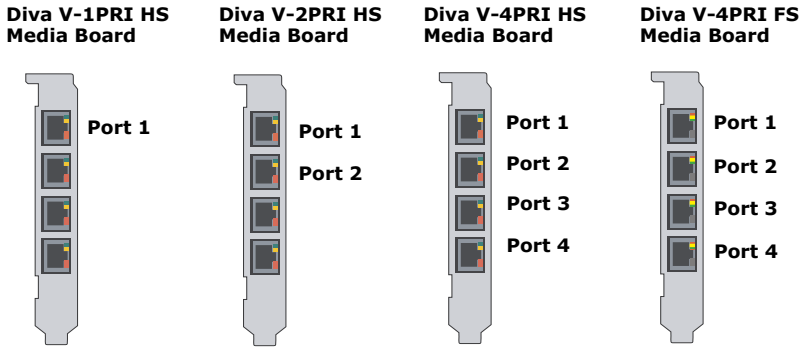

**Note:** Diva V-1PRI PCIe HS, V-2PRI PCIe HS, V-4PRI PCIe HS, and V-4PRI PCIe FS Media Boards do not supply the function of the CSU or DSU internally. You need to purchase it from an independent distributor.

**Diva V-8PRI PCIe FS Media Board**

Diva V-8PRI PCIe FS Media Boards have four RJ45 ports for connecting four dongles. The dongles have two ports each for connecting two separate PRI lines; therefore, you can connect to up to eight PRI lines. You can use any port; typically, you must specify the port number during software configuration. The port numbers are shown below. The diagram is oriented with the edge connector pointing downwards.

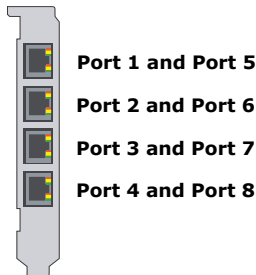

**Note:** Diva V-8PRI PCIe FS Media Boards do not supply the function of the CSU or DSU internally. You need to purchase it from an independent distributor.

**Connect the Diva V-8PRI PCIe FS Media Board as shown in this graphic:**

1. Take the four cables with the dongle and plug the RJ45 connectors into the Diva Media Board.

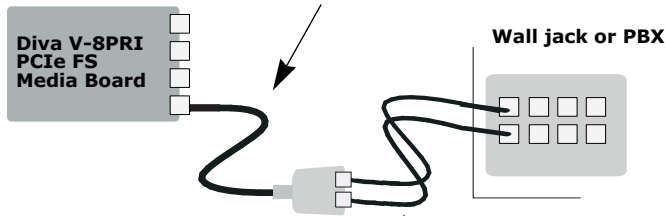

2. Take the eight cables and plug the RJ45 connectors into the dongle. The jack labeled with "A" corresponds to the ports 1,2,3, and 4. The jack labeled with "B" corresponds to the ports 5,6,7, and 8.

3. Plug the RJ45 connectors into the wall jack or PBX.

Contact assignments (plugs and jacks):

RJ45	Signals	Dongle with RJ45 jacks	Signals	
Pin 1	Receive + (RX +) (Port A)	Port A	Pin 1	Receive + (RX +)
Pin 2	Receive - (RX -) (Port A)		Pin 2	Receive - (RX -)
Pin 3	Receive + (RX +) (Port B)		Pin 4	Transmit + (TX +)
Pin 4	Transmit + (TX +) (Port A)		Pin 5	Transmit - (TX -)
Pin 5	Transmit - (TX -) (Port A)	Port B	Pin 1	Receive + (RX +)
Pin 6	Receive - (RX -) (Port B)		Pin 2	Receive - (RX -)
Pin 7	Transmit + (TX +) (Port B)		Pin 4	Transmit + (TX +)
Pin 8	Transmit - (TX -) (Port B)		Pin 5	Transmit - (TX -)

**Note:** Looking at the RJ45 connectors with the exposed connector pins facing you, the pins are numbered from 1 to 8 from left to right as shown below.

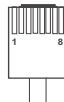

*If the Dialogic® Diva® PRI Media Board in NT mode is connected to a PBX:*

The Dialogic® Diva® System Release software enables you to configure Diva PRI Media Boards as network termination (NT). This means your Diva Media Board can serve as an NT for PBXs that act as terminal equipment and therefore requires an NT to provide a clocking signal. For example, the Diva Media Board can act as an NT when coupling PBXs with the Q.SIG protocol.

When connecting the Diva Media Board to a PBX that acts as TE, configure the Diva Media Board as an NT. Wire it to the PBX as shown in the diagram on page 33 and apply the appropriate assignment to the PBX connectors.

*If the ISDN PRI, E1, or T1 line uses open-ended wire connections:*

In some cases, you are required to connect to your network termination using the open-ended connectors. The transmission (TX) leads and the receiving (RX) leads are identified by color; transmission leads are blue and white-blue, receiving leads are orange and white-orange.

Use an RJ45 to open ends cable:

<b>Dialogic® Diva® PRI Media Board</b>	<b>Signals</b>	<b>Open Ends</b>
Pin 1	Receive + (RX +)	white-orange
Pin 2	Receive - (RX -)	orange
Pin 4	Transmit + (TX +)	white-blue
Pin 5	Transmit - (TX -)	blue
shielded plug	overall shielded	shield

Make sure to connect the transmission leads of your Diva PRI Media Board to the receiving connectors of the network termination and the receiving leads of your Diva PRI Media Board to the transmission connectors of the network termination.

**Note:** If the Diva Media Board is not properly connected to the ISDN PRI, E1, or T1 line, a layer 1 warning light appears on the NT, the Diva Media Board, the external CSU, and at the switching center of the network provider. The network provider might then deactivate the line. If this occurs, you must contact your network provider to reactivate your line.



If the Dialogic® Diva® PRI Media Board is run in back-to-back mode:

The Dialogic® Diva® System Release software enables you to configure Diva PRI Media Boards as network termination (NT). This means you can use two Diva Media Boards in back-to-back operation.

When using Diva Media Boards back-to-back, configure one Diva Media Board as an NT and the other one as TE. Connect the Diva Media Boards with a crossover cable. You can build your own crossover cable using an open-ended ISDN cable. Just crimp the open end according to the NT-side assignment shown in this diagram:

TE Side		Wiring	NT Side	
Pins on RJ45	Signals		Signals	
1	RX +		RX +	
2	RX -		RX -	
3	not used			
4	TX +		TX +	
5	TX -		TX -	
6	not used			
7	not used			
8	not used			

**Note:** Looking at the RJ45 connector with the exposed connector pins facing you, the pins are numbered from 1 to 8 from left to right (as shown below).

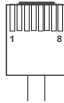

## Connect your Dialogic® Diva® Analog Media Board

Use the cables included with the Diva Analog Media Board. How you connect your Diva Analog Media Board depends on the board type:

- To connect any Dialogic® Diva® Analog-2 Media Board, follow the instructions below.
- To connect any Dialogic® Diva® Analog-4 Media Board, follow the instructions on page 35.
- To connect any Dialogic® Diva® Analog-8 Media Board, follow the instructions on page 36.

**Important:** Use only certified telecommunications cables with No. 26 AWG (American Wire Gauge) or higher with this equipment to ensure proper functioning of the Diva Media Board.

**Dialogic® Diva® Analog-2 Media Boards:**

Diva Analog-2 Media Boards have two RJ10 ports for connecting two separate analog lines. You can use any port; typically, you must specify the port number during software configuration. The port numbers are shown below. The diagram is oriented with the edge connector pointing downwards.

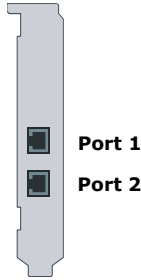

Connect your Dialogic® Diva® Analog-2 Media Board as follows:

- 1. Take the two cables included with the Diva Media Board and plug the RJ10 connectors into the board.**

Wall jack or PBX

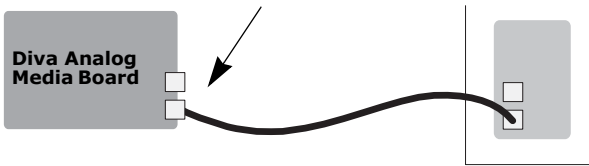

- 2. Plug the RJ11 connectors into the wall jack or PBX.**

Contact assignments (plugs and jacks):

RJ10	Signals	RJ11
Pin 2	Ring	Pin 3
Pin 3	Tip	Pin 4

**Note:** Looking at the RJ10 and RJ11 connector with the exposed connector pins facing you, the pins are numbered from 1 to 4 and 1 to 6 from left to right as shown on the next page.

RJ10 connector

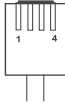

RJ11 connector



### Dialogic® Diva® Analog-4 Media Boards:

Diva Analog-4 Media Boards have four RJ10 ports for connecting four separate analog lines. You can use any port; typically, you must specify the port number during software configuration. The port numbers are shown below. The diagram is oriented with the edge connector pointing downwards.

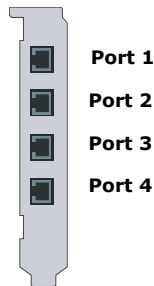

Connect your Diva Analog-4 Media Board as follows:

1. Take the four cables included with the Diva Media Board and plug the RJ10 connectors into the board.



2. Plug the RJ11 connectors into the wall jack or PBX.

Contact assignments (plugs and jacks):

RJ10	Signals	RJ11
Pin 2	Ring	Pin 3
Pin 3	Tip	Pin 4

**Note:** Looking at the RJ10 and RJ11 connector with the exposed connector pins facing you, the pins are numbered from 1 to 4 and 1 to 6 from left to right as shown below.

**RJ10 connector**

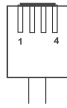

**RJ11 connector**

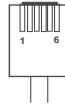

**Dialogic® Diva® Analog-8 Media Boards:**

Diva Analog-8 Media Boards have four RJ45 ports for connecting four dongles. The dongles have two ports each for connecting two separate analog lines; therefore, you can connect to up to eight analog lines. You can use any port; typically, you must specify the port number during software configuration. The port numbers are shown below. The diagram is oriented with the edge connector pointing downwards.

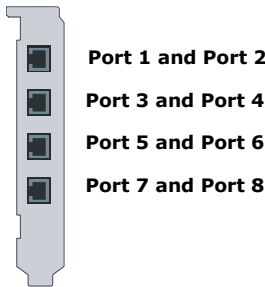

Connect your Dialogic® Diva® Analog-8 Media Board as follows:

1. Take the four cables with the dongle and plug the RJ45 connectors into the Diva Media Board.

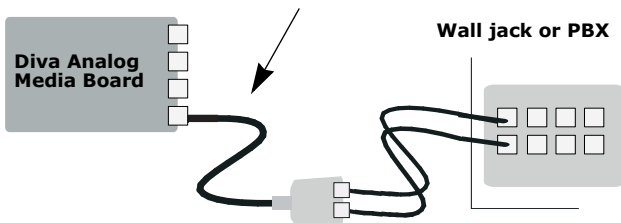

2. Take the eight cables and plug the RJ10 connectors into the dongle. The jack labeled with "A" corresponds to the ports 1,3,5, and 7. The jack labeled with "B" corresponds to the ports 2,4,6, and 8.

3. Plug the RJ11 connectors into the wall jack or PBX.

Contact assignments (plugs and jacks):

RJ45	Signals	Dongle with RJ10 jacks		RJ11
Pin 1	Ring	Port A	Pin 2	Pin 3
Pin 2	Tip		Pin 3	Pin 4
Pin 7	Tip	Port B	Pin 3	Pin 4
Pin 8	Ring		Pin 2	Pin 3

**Note:** Looking at the RJ45, RJ10, and RJ11 connectors with the exposed connector pins facing you, the pins are numbered from 1 to 8, 1 to 4, and 1 to 6 from left to right as shown below.

**RJ45 connector**



**RJ10 connector**



**RJ11 connector**



### (C) Install your Dialogic® Diva® System Release software

To install the Diva System Release software, see the online documentation that came with the drivers or that is available on the Dialogic web site at <http://www.dialogic.com/manuals/default.htm>.

Operating System	Reference Guides
All Windows® operating systems	Dialogic® Diva® System Release WIN Reference Guide
Linux	Dialogic® Diva® System Release LIN Reference Guide

## Troubleshooting

If you are having problems with your Dialogic® Diva® Media Board or with the corresponding software, the following suggestions can help you try to diagnose and solve the problems. If these suggestions do not work for you, try the suggestions described in the online reference guides or in the help files for the corresponding software, or those on the Dialogic Services & Support web site (see page 83).

### Using the Dialogic® Diva® Line Test tool

**Note:** The Diva Line Test tool is only available under Microsoft® Windows® operating systems.

The Diva Line Test tool allows for quickly verifying that your Dialogic® Diva® Media Board and the line are working properly.

To open Diva Line Test tool click:

**Start > Programs > Dialogic Diva > Line Test.**

The Diva Line Test tool offers the following tests:

- **Line Check:** Performs a quick check of your Dialogic® Diva® System Release software installation and the physical connection.
- **Hardware Test:** Performs a test only of the controller.
- **Phone/Loop:** Performs basic inband or outband phone tests, to verify the connection to other telephones or to itself.
- **Call Transfer:** Performs different call transfer tests, with the option to choose the transfer type.
- **Fax:** Performs basic inbound or outbound fax tests.

For more information about the tests of this tool, see Dialogic® Diva® Line Test Online Help file (DSLLineTest.chm).

## Checking the status LEDs

The Dialogic® Diva® BRI and PRI Media Boards have two or four status LEDs that indicate a specific status of the Diva Media Board.

### Dialogic® Diva® BRI and Diva UM-BRI Media Boards

The Diva BRI-CTI, Diva BRI-2FX, Diva BRI-2, Diva UM-BRI-2, Diva 4BRI-8, and Diva UM-4BRI-8 Media Boards have two LEDs for each port:

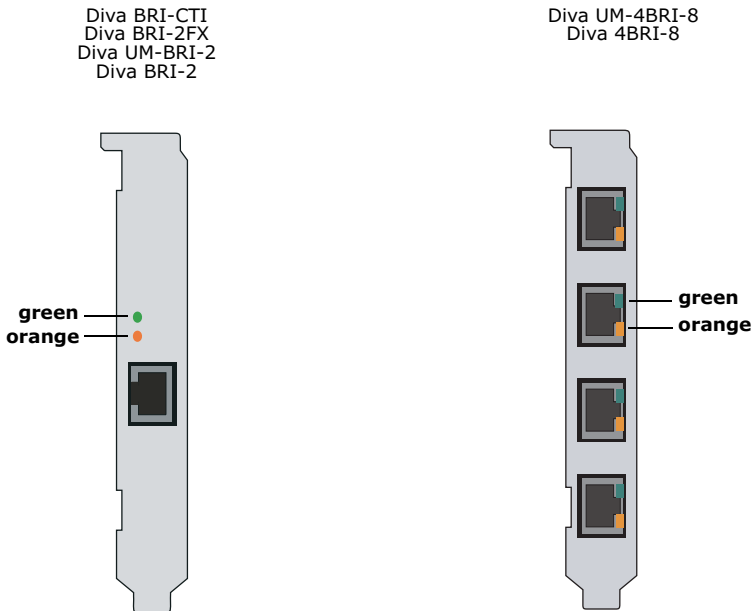

The table below describes the function of the LEDs:

Color	Status	Description
green	off	Layer 1 is not active.
	lit	Layer 1 is active. The cabling and the connection to the ISDN work properly.
orange	off	Layer 2 is not active.
	lit	Layer 2, i.e., the D-channel, is active. In Europe, the status of the D-channel depends on the switch configuration; the LED might remain lit for the duration of the call or it might remain lit continuously. In North America, the D-channel is always active and, as such, the LED remains lit.

## Dialogic® Diva® V-PRI, Diva UM-PRI, and Diva PRI Media Boards

Diva PRI Media Boards with one port have four LEDs:

Div a V-PRI  
Div a UM-PRI  
Div a PRI 3.0

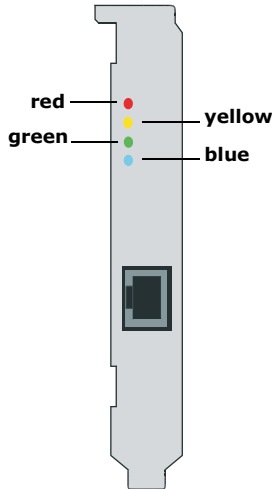

The table below describes the function of each LED:

Color	Status	Description
yellow	off	Normal operation.
	lit	Remote site is experiencing synchronization problems (if a remote alarm/yellow alarm is detected).
red	off	Normal operation.
	lit	The receiver does not detect a signal (loss of signal/red alarm).
blue	off	Normal operation.
	lit	Received frames are not synchronized properly (alarm indication signal/blue alarm).
green	off	Layer 2 is not active. Check your layer 2 configuration, i.e., switch type, switch etc.
	lit	Layer 2 is active. If your Dialogic® Diva® Media Board works properly, layer 2 is always active.



## Dialogic® Diva® V-2PRI and V-4PRI Media Boards

Diva V-xPRI PCI Media Boards have two multifunctional LEDs for each port:

Diva V-2PRI

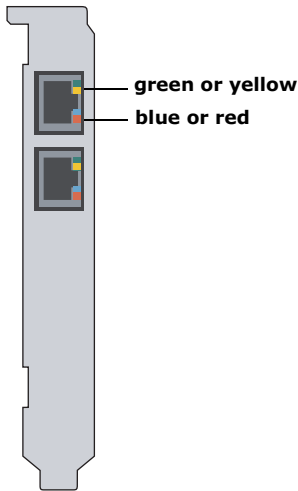

Diva V-4PRI

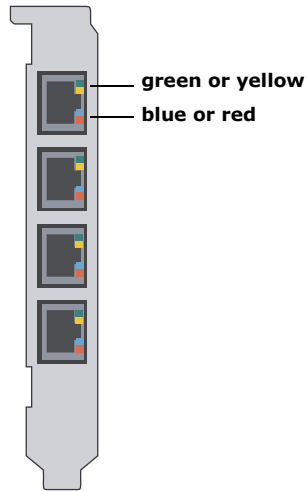

The table below describes the function of each LED:

Color	Status	Description
green	off	Layer 2 is not active. Check your layer 2 configuration, i.e., switch type, switch etc.
	lit	Layer 2 is active. If your Dialogic® Diva® Media Board works properly, layer 2 is always active.
yellow	off	Normal operation.
	lit	Remote site is experiencing synchronization problems (if a remote alarm/yellow alarm is detected).
red	off	Normal operation.
	lit	The receiver does not detect a signal (loss of signal/red alarm).
blue	off	Normal operation.
	lit	Received frames are not synchronized properly (alarm indication signal/blue alarm).

## Dialogic® Diva® V-1PRI PCIe HS, V-2PRI PCIe HS, V-4PRI PCIe HS Media Boards

Diva V-xPRI PCIe HS Media Boards have multifunctional LEDs:

Diva V-1PRI PCIe HS  
 Diva V-2PRI PCIe HS  
 Diva V-4PRI PCIe HS

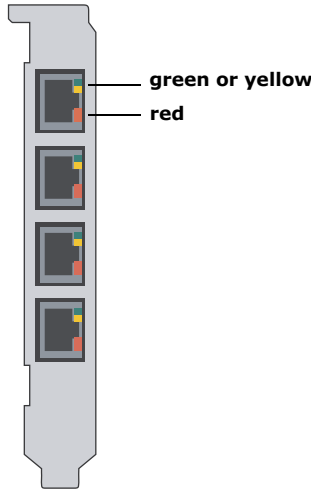

**Note:** On Diva V-1PRI PCIe HS and Diva V-2PRI PCIe HS Media Boards, not all ports are activated. See the note on page 30 for more information.

The table below describes the function of each LED:

Color	Status	Description
green	off	Layer 2 is not active. Check your layer 2 configuration, i.e., switch type, switch etc.
	lit	Layer 2 is active. If your Dialogic® Diva® Media Board works properly, layer 2 is always active.
yellow	off	Normal operation.
	lit	Remote site is experiencing synchronization problems (if a remote alarm/yellow alarm is detected).
red	off	Normal operation.
	lit	The receiver does not detect a signal (loss of signal/red alarm).

## Dialogic® Diva® V-4PRI PCIe FS and V-8PRI PCIe FS Media Boards

Diva V-xPRI PCIe FS Media Boards have multifunctional LEDs:

Diva V-4PRI PCIe FS

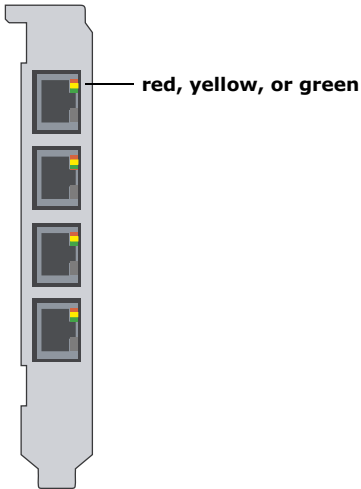

Diva V-8PRI PCIe FS

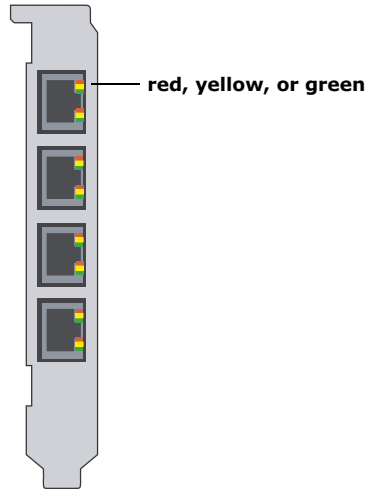

The table below describes the function of each LED:

Color	Status	Description
All colors	off	Software has not initialized
green	lit	Carrier Sense (normal error free operation)
yellow	lit	Yellow alarm
	slow flashing together	Blue alarm
red	lit	Red alarm

## Technical Specifications

### Environmental requirements:

- Operating temperature: 10 degrees C to 50 degrees C
- Maximum tolerance in voltage fluctuation: according to the respective specification (PCI/PCIe)

	<b>Diva UM-BRI-2 Diva BRI-2</b>	<b>Diva UM-4BRI-8 Diva 4BRI-8</b>
Bus type	PCI (3.3/5.0 V)	
CPU	32 Bit RISC CPU, 100 MHz	
Memory	8 MB SDRAM	16 MB SDRAM
IRQ levels	Allocated by PC BIOS	
I/O base addr. (hex)		
Shared memory range	8 MB	16 MB
DSPs	2 ADSPs 2185	8 ADSPs 2185
Dimensions in mm (length x height)		
PCB	167.65 x 64.41	174.63 x 106.68
Low profile bracket	181.36 x 80.06	
Bracket	180.96 x 120.88	187.84 x 126.37
Data transfer		
B-channels	2 x 64 kbps	4 x 2 x 64 kbps
D-channels	1 x 16 kbps	4 x 16 kbps
Plug&Play	yes	
Power safe mode		
Ports	Female RJ45 (ISDN BRI)	4 x Female RJ45 (ISDN BRI)
Physical interfaces	ISDN basic rate interface	4 x ISDN basic rate interface
Power requirements	0.33 A @ +5 V typ.	0.58 A @ +5 V typ.

	<b>Div a UM-BRI-2 PCIe Div a BRI-2 PCIe</b>	<b>Div a UM-4BRI-8 PCIe Div a 4BRI-8 PCIe</b>
Bus type	PCIe 1.0a x1 lane	
CPU	32 Bit RISC CPU, 100 MHz	
Memory	64 MB SDRAM	
IRQ levels	Allocated by PC BIOS	
I/O base addr. (hex)		
Shared memory range	8 MB	16 MB
DSPs	2 ADSPs 2185	8 ADSPs 2185
Dimensions in mm (length x height)		
PCB	167.65 x 68.90	167.65 x 111.15
Low profile bracket	181.36 x 80.06	
Bracket	180.96 x 120.88	180.96 x 126.31
Data transfer in kbps		
B-channels	2 x 64 kbps	4 x 2 x 64 kbps
D-channels	1 x 16 kbps	4 x 16 kbps
Plug&Play	yes	
Power safe mode		
Ports	Female RJ45 (ISDN BRI)	4 x Female RJ45 (ISDN BRI)
Physical interfaces	ISDN basic rate interface	4 x ISDN basic rate interface
Power requirements	0.27 A @ 3.3 V typ. 0.17 A @ 12 V typ.	0.42 A @ 3.3 V typ. 0.19 A @ 12 V typ.

	<b>Diva BRI-CTI Diva BRI-2FX</b>
Bus type	PCI (3.3/5.0 V)
CPU	32 Bit RISC CPU, 133 MHz
Memory	8 MB SDRAM
IRQ levels	Allocated by PC BIOS
I/O base addr. (hex)	
Shared memory range	8 MB
DSPs	none
Dimensions in mm (length x height)	
PCB	167.65 x 64.41
Low profile bracket	181.36 x 80.06
Bracket	180.96 x 120.88
Data transfer in kbps	
B-channels	2 x 64 kbps
D-channel	1 x 64 kbps
Plug&Play	yes
Power safe mode	
Port	Female RJ45 (ISDN BRI)
Physical interface	ISDN basic rate interface
Power requirements	0.3 A @ +5 V typ.

	<b>Div V-PRI Div UM-PRI Div PRI 3.0</b>
Bus type	PCI (3.3/5.0 V)
CPU	32 Bit RISC CPU, 300 MHz
Memory	64 MB SDRAM
IRQ levels	Allocated by PC BIOS
I/O base addr. (hex)	
Shared memory range	8 MB
DSPs	either 2, 10, 24, or 31 ADSPs 2185
Dimensions in mm	PRI/E1/T1-CTI, PRI/E1/T1-8:
PCB	174.63 x 106.68
Bracket	187.84 x 126.37
Dimensions in mm (length x height)	PRI/E1-30, V-PRI:
PCB	312.00 x 106.68
Bracket without retainer	325.31 x 126.37
Bracket and retainer	352.17 x 126.37
Data transfer in kbps	
B-channels	23 or 30 x 64 kbps
D-channel (PRI)	1 x 64 kbps
Channelized T1	1 x 56 kbps
Plug&Play	yes
Power safe mode	
Port	Female RJ-45 (ISDN PRI)
Physical interface	ISDN primary rate interface
Power requirements	PRI/E1/T1-CTI: 0.58 A @ +5 V typ. 1.70 A @ +5 V max. PRI/E1/T1-8: 0.65 A @ +5 V typ. 2.00 A @ +5 V max. PRI/T1-24, PRI/E1-30, V-PRI: 0.97 A @ +5 V typ. 2.70 A @ +5 V max.

	<b>Diva V-PRI PCIe</b> <b>Diva UM-PRI PCIe</b> <b>Diva PRI PCIe</b>
Bus type	PCIe 1.0a x1 lane
CPU	32 Bit RISC CPU, 300 MHz
Memory	64 MB SDRAM
IRQ levels	Allocated by PC BIOS
I/O base addr. (hex)	
Shared memory range	8 MB
DSPs	either 2, 24, or 31 ADSPs 2185
Dimensions in mm (length x height)	PRI/E1/T1-CTI PCIe:
PCB	167.65 x 68.90
Low profile bracket	181.38 x 80.06
Bracket	180.96 x 120.88
Dimensions in mm	PRI/T1-24 PCIe, PRI/E1-30 PCIe, V-PRI PCIe:
PCB	312.00 x 111.15
Bracket without retainer	325.31 x 126.31
Bracket and retainer	352.17 x 126.31
Data transfer in kbps	
B-channels	23 or 30 x 64 kbps
D-channel (PRI)	1 x 64 kbps
Channelized T1	24 x 56 kbps
Plug&Play	yes
Power safe mode	
Port	Female RJ45 (ISDN PRI)
Physical interface	Primary rate interface or channelized T1 interface
Power requirements	PRI/E1/T1-CTI PCIe: 0.96 A @ +3.3 V typ. 0.04 A @ +12 V typ. PRI/T1-24 PCIe, V-PRI/T1-24 PCIe: 2.1 A @ +3.3 V typ. 0.03 A @ +12 V typ. PRI/E1-30 PCIe, V-PRI/E1-30 PCIe: 2.3 A @ +3.3 V typ. 0.03 A @ +12 V typ.



	<b>Diva V-2PRI</b>	<b>Diva V-4PRI</b>
Bus type	PCI (3.3/5.0 V)	
CPU	64 Bit RISC CPU, 466 MHz	
Memory	64 MB SDRAM	
IRQ levels	Allocated by PC BIOS	
I/O base addr. (hex)		
Shared memory range	8 MB	
DSPs	10 ADSPs-BF533 (32 MB SDRAM)	20 ADSPs-BF533 (32 MB SDRAM)
Dimensions in mm (length x height)		
PCB	312.00 x 106.68	
Bracket without retainer	325.31 x 126.37	
Bracket and retainer	352.17 x 126.37	
Data transfer in kbps		
B-channels	2 x 23 x 64 kbps or 2 x 30 x 64 kbps	4 x 23 x 64 kbps or 4 x 30 x 64 kbps
D-channels (PRI)	2 x 64 kbps	4 x 64 kbps
Channelized T1	2 x 24 x 56 kbps	4 x 24 x 56 kbps
Plug&Play	yes	
Power safe mode		
Ports	2 x Female RJ45 (ISDN PRI)	4 x Female RJ45 (ISDN PRI)
Physical interfaces	2 x ISDN primary rate interface or 2 x channelized T1 interface	4 x ISDN primary rate interface or 4 x channelized T1 interface
Power requirements	3.0 A @ +3.3 V typ. 4.9 A @ +3.3 V max. 0.02 A @ +5 V typ. 0.04 A @ +5 V max.	5.5 A @ +3.3 V typ. 6.5 A @ +3.3 V max. 0.04 A @ +5 V typ. 0.08 A @ +5 V max.

	<b>Diva V-1PRI PCIe HS</b>	<b>Diva V-2PRI PCIe HS</b>	<b>Diva V-4PRI PCIe HS</b>
Bus type	PCIe 1.0a x1 lane		
CPU	64 Bit RISC CPU, 466 MHz		
Memory	64 MB SDRAM		
IRQ levels	Allocated by PC BIOS		
I/O base addr. (hex)			
Shared memory range	8 MB		
DSPs	12 ADSPs-BF533 (32 MB SDRAM)		
Dimensions in mm (length x height)			
PCB	167.65 x 111.15		
With bracket	180.96 x 126.31		
Data transfer			
B-channels	1 x 23 x 64 kbps or 1 x 30 x 64 kbps	2 x 23 x 64 kbps or 2 x 30 x 64 kbps	4 x 23 x 64 kbps or 4 x 30 x 64 kbps
D-channels (PRI)	1 x 64 kbps	2 x 64 kbps	4 x 64 kbps
Channelized T1	1 x 24 x 56 kbps	2 x 24 x 56 kbps	4 x 24 x 56 kbps
Plug&Play	yes		
Power safe mode			
Ports	1 x Female RJ45 (ISDN PRI)	2 x Female RJ45 (ISDN PRI)	4 x Female RJ45 (ISDN PRI)
Physical interfaces	1 x ISDN primary rate interface or 1 x channelized T1 interface	2 x ISDN primary rate interface or 2 x channelized T1 interface	4 x ISDN primary rate interface or 4 x channelized T1 interface
Power requirements	0.91 A @ 3.3 V max. 1.00 A @ 12 V max.		

	<b>Diva V-4PRI PCIe FS</b>	<b>Diva V-8PRI PCIe FS</b>
Bus type	PCIe 1.0a x4 lane	
CPU	64 Bit RISC CPU, 466 MHz	
Memory	128 MB DDR2-SDRAM	
IRQ levels	Allocated by PC BIOS	
I/O base addr. (hex)		
Shared memory range	8 MB	
DSPs	24 ADSPs-BF533 (32 MB SDRAM)	
Dimensions in mm (length x height)		
PCB	312.00 x 111.15	
Bracket without retainer	325.31 x 126.31	
Bracket and retainer	352.17 x 126.31	
Data transfer		
B-channels	4 x 23 x 64 kbps or 4 x 30 x 64 kbps	8 x 23 x 64 kbps or 8 x 30 x 64 kbps
D-channels (PRI)	4 x 64 kbps	8 x 64 kbps
Channelized T1	4 x 24 x 56 kbps	8 x 24 x 56 kbps
Plug&Play	yes	
Power safe mode		
Ports	4 x Female RJ45 (ISDN PRI)	8 x Female RJ45 (ISDN PRI)
Physical interfaces	4 x ISDN primary rate interface or 4 x channelized T1 interface	8 x ISDN primary rate interface or 8 x channelized T1 interface
Power requirements	1.8 A @ 3.3 V typ. 1.5 A @ 12 V typ.	

	<b>Diva UM-Analog-2 Diva Analog-2</b>	<b>Diva UM-Analog-4 Diva UM-Analog-8 Diva Analog-4 Diva Analog-8</b>
Bus type	PCI (3.3/5.0 V)	
CPU	32 Bit RISC CPU, 100 MHz	
Memory	16 MB SDRAM	
IRQ levels	Allocated by PC BIOS	
I/O base addr. (hex)		
Shared memory range	16 MB	
DSPs	either 2, 4, or 8 ADSPs 2185 according to model	
Dimensions in mm (length x height)		
PCB	167.65 x 64.41	312.00 x 106.68
Low profile bracket	181.36 x 80.06	
Bracket	180.96 x 120.88	
Bracket without retainer		325.31 x 126.37
Bracket and retainer		352.17 x 126.37
Data transfer	max. 2, 4, or 8 x 56 kbps according to model	
Plug&Play	yes	
Power safe mode		
Ports	2 RJ10 jacks	Analog-4: 4 RJ10 jacks Analog-8: 4 RJ45 jacks
Physical interfaces	2, 4, or 8 x analog interface V.90 according to model	
Power requirements	0.34 A @ +5 V typ.	Analog-4: 0.45 A @ +5 V typ. Analog-8: 0.5 A @ +5 V typ.

	<b>Diva UM-Analog-2 PCIe Diva Analog-2 PCIe</b>	<b>Diva UM-Analog-4 PCIe Diva UM-Analog-8 PCIe Diva Analog-4 PCIe Diva Analog-8 PCIe</b>
Bus type	PCIe 1.0a x1 lane	
CPU	32 Bit RISC CPU, 100 MHz	
Memory	16 MB SDRAM	
IRQ levels	Allocated by PC BIOS	
I/O base addr. (hex)		
Shared memory range	16 MB	
DSPs	either 2, 4, or 8 ADSPs 2185 according to model	
Dimensions in mm (length x height)		
PCB	167.65 x 68.90	167.65 x 111.15
Low profile bracket	181.38 x 80.06	
Bracket	180.96 x 120.88	180.96 x 126.31
Data transfer in kbps	max. 2, 4, or 8 x 56 kbps according to model	
Plug&Play	yes	
Power safe mode		
Ports	2 RJ10 jacks	Analog-4: 4 RJ10 jacks Analog-8: 4 RJ45 jacks
Physical interfaces	2, 4, or 8 x analog interface V.90 according to model	
Power requirements	0.26 A @ 3.3 V typ. 0.16 A @ 12 V typ.	Analog-4: 0.26 A @ 3.3 V typ. 0.18 A @ 12 V typ.  Analog-8: 0.34 A @ 3.3 V typ. 0.22 A @ 12 V typ.

## International Regulatory Information

### Regulatory information for the USA

---

**WARNING:** Changes or modifications to this unit not expressly approved by Dialogic Corporation could void the user's authority to operate the equipment.



### FCC Declaration of Conformity



We:

Dialogic  
1515 Route 10  
Parsippany  
NJ 07054  
Tel: (973) 967-6000

Declare under our sole legal responsibility that the products listed below to which this declaration relates, are in conformity with Part 15 of the FCC Rules. Operation is subject to the following two conditions:

- (1) This device may not cause harmful interference, and
- (2) this device must accept any interference received, including interference that may cause undesired operation.

**Note:** This equipment has been tested and found to comply with the limits for a Class B digital device, pursuant to Part 15 of the FCC Rules. These limits are designed to provide reasonable protection against harmful interference in a residential installation. This equipment generates, uses and can radiate radio frequency energy and, if not installed and used in accordance with the instructions, may cause harmful interference to radio communications.

However, there is no guarantee that interference will not occur in a particular installation. If this equipment does cause harmful interference to radio or television reception, which can be determined by turning the equipment off and on, the user is encouraged to try to correct the interference by one or more of the following measures:

- Reorient or relocate the receiving antenna.
- Increase the separation between the equipment and receiver.
- Connect the equipment into an outlet on a circuit different from that to which the receiver is connected.
- Consult the dealer or an experienced radio/TV technician for help.

## FCC Part 68 Notice

This equipment complies with Part 68 of the FCC rules and the requirements adopted by the ACTA. On the bottom of this equipment is a label that contains, among other information, a FCC part 68 registration number or a product identifier in the format US: AAEEQ##TXXXX. If requested, this information must be provided to the telephone company.

A plug and jack used to connect this equipment to the premises wiring and telephone network must comply with the applicable FCC part 68 rules and requirements adopted by the ACTA. A compliant telephone cord and modular plug is provided with this product. It is designed to be connected to a compatible modular jack that is also compliant.

The REN is used to determine the number of devices that may be connected to a telephone line. Excessive RENs on a telephone line may result in the devices not ringing in response to an incoming call. In most but not all areas, the sum of RENs should not exceed five (5.0). To be certain of the number of devices that may be connected to a line, as determined by the total RENs, contact the local telephone company.

If this equipment causes harm to the telephone network, the telephone company will notify you in advance that temporary discontinuance of service may be required. But if advance notice is not practical, the telephone company will notify the customer as soon as possible.

Also, you will be advised of your right to file a complaint with the FCC if you believe it is necessary.

The telephone company may make changes in its facilities, equipment, operations, or procedures that could affect the operation of the equipment. If this happens, the telephone company will provide advance notice in order for you to make the necessary modifications in order to maintain uninterrupted service.

If trouble is experienced with this equipment, please contact us for repair and warranty information. If the trouble is causing harm to the telephone network, the telephone company may request you to remove the equipment from the network until the problem is resolved.

Dialogic  
1515 Route 10  
Parsippany  
NJ 07054  
Tel: (973) 967-6000

This unit contains no user-serviceable parts.

Connection to party lines is subject to state tariffs. Contact the state public utility commission, public service commission or corporation commission for information.

The mounting of the approved products in the final assembly must be made so that the approved products are isolated from exposure to any hazardous voltages within the assembly. Adequate separation and restraint of cables and cords must be provided. The final assembler shall provide in the consumer instructions all applicable customer information.

The Telephone Consumer Protection Act of 1991 makes it unlawful for any person to use a computer or other electronic device to send any message via a telephone fax machine unless such message clearly contains in a margin at the top or bottom of each transmitted page or on the first page of the transmission, the date and time it is sent and an identification of the business or other entity, or other individual sending the message and the telephone number of the sending machine or such business, other entity, or individual. The telephone number provided may not be a 900 number or any other number for which charges exceed local or long-distance transmission charges.

It is the responsibility of the end user or developer to ensure that the regulations set forth in the preceding paragraph are followed. Application developers must provide support for fax branding in the applications they develop and inform users of their responsibility under the Act along with instructions for use. Developers can find instructions for setting up a fax header in the Dialogic software reference manual. End users should consult the documentation that is provided with their computer telephony application for instructions on fax branding identification.

**Dialogic® Diva® Basic Rate Interface (BRI) Media Boards:**

	<b>Facility Interface code</b>	<b>Digital Reg. code</b>	<b>Service Order code</b>	<b>USOC Jack Type</b>
Without Fax option	02IS5	XD	6.0N	N/A
With Fax option	02IS5	XD	6.0P	N/A

**Dialogic® Diva® Primary Rate Interface (PRI) Media Boards:**

<b>Facility Interface code</b>	<b>Digital Reg. code</b>	<b>Service Order code</b>	<b>USOC Jack Type</b>
04DU9-1SN 04DU9-BN 04DU9-DN 04DU9-1KN	DD	6.0F	RJ48-C
04DU9-1SN 04DU9-BN 04DU9-DN 04DU9-1KN	XD	6.0N	RJ48-C



**Dialogic® Diva® Analog Media Boards:**

	<b>REN</b>	<b>USOC Jack Type</b>
Diva Analog-2 Diva Analog-4 Diva Analog-8	0.2B	RJ11-C
Diva UM-Analog-2 Diva UM-Analog-4 Diva UM-Analog-8		
Diva Analog-2 PCIe Diva Analog-4 PCIe Diva Analog-8 PCIe	0.1B	RJ11-C
Diva UM-Analog-2 PCIe Diva UM-Analog-4 PCIe Diva UM-Analog-8 PCIe		

**Regulatory information for Canada**

**NOTICE:** This product meets the applicable Industry Canada technical specifications.

Le présent matériel est conforme aux spécifications techniques applicables d'Industrie Canada.

This Class B digital apparatus complies with Canadian ICES-003.

Cet appareil numérique de la classe B est conforme à la norme NMB-003 du Canada.

**Dialogic® Diva® Analog Media Boards**

Dialogic® Diva® Analog PCI Media Boards have a REN of 0.2.

Dialogic® Diva® Analog PCIe Media Boards have a REN of 0.1.

**Regulatory information for Europe**

To receive detailed approval information, go to <http://www.dialogic.com/declarations>.

All Dialogic® Diva® Media Boards are certified in Europe (CE mark) and North America (FCC and Industry Canada).

Approval in Europe includes only countries that accept European Union approval (CE mark): Austria, Belgium, Cyprus, Czech Republic, Denmark, Estonia, Finland, France, Germany, Greece, Hungary, Iceland, Ireland, Italy, Latvia, Lithuania, Luxembourg, Malta, Netherlands, Norway, Poland, Portugal, Slovakia, Slovenia, Spain, Sweden, Switzerland, and United Kingdom.

Some other countries in Eastern Europe and the Mediterranean region also accept the CE-mark. If you are unsure, please check with your equipment supplier, service provider or regulatory authority for confirmation.

The Dialogic® products covered by this notice meet the following European Directives:

2006/95/EC Safety/Low Voltage Directive

2004/108/EC EMC Directive

99/05/EC R&TTE Directive

To achieve CE compliance, be sure to select a host that already meets the EMC and Low Voltage Directives before the addition of any optional board. Remember that the use of option boards declared compliant with the Directives by their manufacturer only gives "presumption of compliance" for the whole system. It is the responsibility of the system supplier to verify that the requirements of the listed Directives are still met by the final system, as supplied to the end-user. System integrators should take notice of further conditions expressed in this section and the Safety section.

#### **Dialogic® Diva® BRI Media Boards**

The products covered by this notice have been successfully tested against TBR 3 basic call control. Application developers implementing supplementary services at application level must ensure that their implementation complies with the services offered by the local Public Switched Telephone Network (PSTN) operator. In case of doubt, network specifications must be consulted; the R&TTE Directive imposes that each PSTN operator makes such specifications available.

Inter-working is guaranteed only with Public Switched Telephone Networks (PSTNs) offering Basic Rate Access conforming to EuroISDN specifications.

Before any connection to PSTN offering other Basic Rate Access to other national or international BRI standards, please consult your Dialogic representative for standards other than EuroISDN.

#### **Dialogic® Diva® PRI Media Boards**

The products covered by this notice have been successfully tested against TBR 4 basic call control. Application developers implementing supplementary services at application level must ensure that their implementation complies with the services offered by the local Public Switched Telephone Network (PSTN) operator. In case of doubt, network specifications must be consulted; the R&TTE Directive imposes that each PSTN operator makes such specifications available.

Inter-working is guaranteed only with Public Switched Telephone Networks (PSTNs) offering Primary Rate Access conforming to EuroISDN specifications.

Before any connection to PSTN offering Primary Rate Access to other national or international E1 standards, please consult your Dialogic representative.

### **Dialogic® Diva® Analog Media Boards**

This equipment has been tested against TBR 21 requirements (January 1998 edition - Terminal Equipment (TE) capable of 2-wire access to an analogue Public Switched Telephone Network (PSTN), that is capable of originating a circuit-switched call using Dual Tone Multi Frequency (DTMF) signaling and/or receiving an incoming circuit-switched call).

Due to differences among the individual PSTNs provided in different countries, compliance to TBR 21 does not, of itself, give an unconditional assurance of successful operation on every PSTN network termination point.

In the event of problems, you should first contact your equipment supplier.

### **Conditions for TBR3, TBR4, and TBR 21 Compliance**

To comply with the TBRs, be sure to adhere to the following requirements:

- The appropriate parameter file must be installed on the system and enabled on these products. To enable it under Windows®, see below. For Linux, see page 60.

#### **Under Windows®:**

1. Click **Start > Programs > Dialogic Diva > Configuration Manager**.
2. Click the icon of the Dialogic® Diva® Media Board in the **Lines** layer of the **Configuration Pane**.
3. In the **Properties Pane**, select your country-specific protocol from the dropdown menu under **Country Selection** (for Diva Analog Media Boards) or under **Switch Type** (for Diva BRI and PRI Media Boards).

**Note:** The graphic on the next page shows the parameters and values for a Diva Analog Media Board configuration. The available D-channel protocols depend on the installed Diva Media Board. The menu options for Diva BRI and PRI Media Boards are slightly different as well.

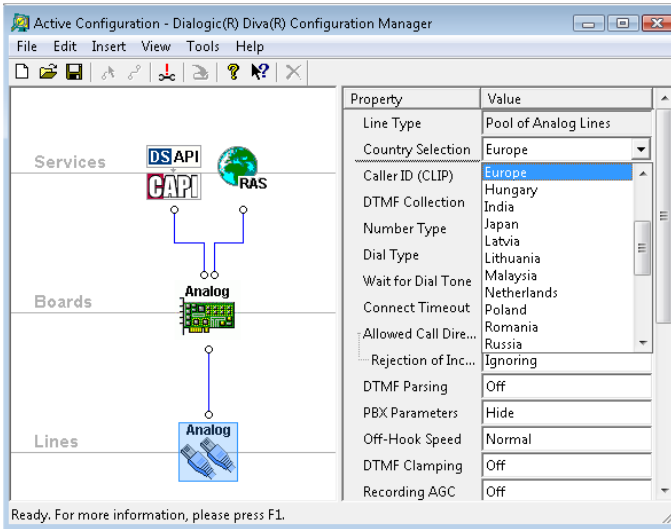

**Under Linux:**

1. Open the Dialogic® Diva® Linux System Release software web interface
2. Click **Board configuration** and select the Dialogic® Diva® Media Board you want to configure.
3. In the **Board Configuration - Detail** select your country-specific protocol from the dropdown menu next to **D-Channel Protocol**.

Dialogic Diva Analog-8 PCI v1, SN:1216

Parameter	Value
D-Channel Protocol:	TBR21 - Europe/other countries
Use Caller ID (CID):	TBR21 - Europe/other countries
Trunk Dialing Mode:	USA-CAN - USA/Canada
Wait for dial tone:	DENMARK - Denmark
Voice Companding:	SWEDEN - Sweden
View Extended Configuration	UAE - United Arabian Emirates
	NETHERLANDS - Netherlands
	AUSTRALIA - Australia
	JAPAN - Japan
	UK - Great Britain
	SOUTH-KOREA - South Korea
	CHINA - China

Save Cancel

**Note:** The above graphic shows the parameters and values for a Diva Analog Media Board configuration. The available D-channel protocols

depend on the installed Diva Media Board. The menu options for Diva BRI and PRI Media Boards are slightly different as well.

- These products do not perform automatically repeated call attempts; however, they do not include protection against repeated call requests from the controlling application software.
- To meet the requirements of TBR 21 § 4.8.3, the application software shall not submit call requests that violate the following rules:
  - The number of repeated call attempts [to the same number] is restricted to 15.
  - The interval between subsequent call attempts [to the same number] is at least 5 seconds.

## EU Declaration of Conformity

Dialogic Corporation declares that this equipment is in compliance with the Radio and Telecommunication Terminal Equipment directive 1999/5/EC with requirements covering the Electromagnetic Compatibility Directive 2004/108/EC and the Low Voltage Directive 2006/95/EC. A detailed declaration of conformity for this product can be found at: [www.dialogic.com/declarations](http://www.dialogic.com/declarations)

These products are compatible with analog lines to the Public Switched Telephone Network (PSTN) in the following countries:

Austria, Belgium, Cyprus, Czech Republic, Denmark, Estonia, Finland, France, Germany, Greece, Hungary, Iceland, Ireland, Italy, Latvia, Liechtenstein, Lithuania, Luxembourg, Malta, The Netherlands, Norway, Poland, Portugal, Slovakia, Slovenia, Spain, Sweden, Switzerland, and The United Kingdom.

Manufacturer's office in European Union:

Dialogic Distribution Limited  
Unit 4034  
Citywest Business Campus  
Saggart, Co. Dublin  
IRELAND  
Tel: +353 1 630 9000  
Fax: +353 1 630 9099

**CS:** Dialogic Corporation tímto prohlašuje, že tento ITE je ve shodě se základními požadavky a dalšími příslušnými ustanoveními směrnice 1999/5/ES.

**DA:** Undertegnede Dialogic Corporation erklærer herved, at følgende udstyr ITE overholder de væsentlige krav og øvrige relevante krav i direktiv 1999/5/EF.

**DE:** Hiermit erklärt Dialogic Corporation, dass sich das Gerät ITE in Übereinstimmung mit den grundlegenden Anforderungen und den übrigen relevanten Bestimmungen der Richtlinie 1999/5/EG befindet.

**EL:** ΜΕ ΤΗΝ ΠΑΡΟΥΣΙΑ Dialogic Corporation ΔΗΛΩΝΕΙ ΟΤΙ ΙΤΕ ΣΥΜΜΟΡΦΩΝΕΤΑΙ ΠΡΟΣ ΤΙΣ ΟΥΣΙΩΔΕΙΣ ΑΠΑΙΤΗΣΕΙΣ ΚΑΙ ΤΙΣ ΛΟΙΠΕΣ ΣΧΕΤΙΚΕΣ ΔΙΑΤΑΞΕΙΣ ΤΗΣ ΟΔΗΓΙΑΣ 1999/5/ΕΚ.

**EN:** Hereby, Dialogic Corporation, declares that this ITE is in compliance with the essential requirements and other relevant provisions of Directive 1999/5/EC.

**ES:** Por medio de la presente Dialogic Corporation declara que el ITE cumple con los requisitos esenciales y cualesquiera otras disposiciones aplicables o exigibles de la Directiva 1999/5/EC.

**ET:** Käesolevaga kinnitab Dialogic Corporation seadme ITE vastavust direktiivi 1999/5/EÜ põhinõuetele ja nimetatud direktiivist tulenevatele teistele asjakohastele sätetele.

**FI:** Dialogic Corporation vakuuttaa täten että ITE tyyppinen laite on direktiivin 1999/5/EY oleellisten vaatimusten ja sitä koskevien direktiivin muiden ehtojen mukainen.

**FR:** Par la présente Dialogic Corporation déclare que l'appareil ITE est conforme aux exigences essentielles et aux autres dispositions pertinentes de la directive 1999/5/CE.

**HU:** Alulírott, Dialogic Corporation nyilatkozom, hogy a ITE megfelel a vonatkozó alapvető követelményeknek és az 1999/5/EC irányelv egyéb előírásainak.

**IC:** Hér með lýsir Dialogic Corporation yfir því að ITE er í samræmi við grunnkröfur og aðrar kröfur, sem gerðar eru í tilskipun 1999/5/EC.

**IT:** Con la presente Dialogic Corporation dichiara che questo ITE è conforme ai requisiti essenziali ed alle altre disposizioni pertinenti stabilite dalla direttiva 1999/5/CE.

**LT:** Šiuo Dialogic Corporation deklaruoja, kad šis ITE atitinka esminius reikalavimus ir kitas 1999/5/EB Direktyvos nuostatas.

**LV:** Ar šo Dialogic Corporation deklarē, ka ITE atbilst Direktīvas 1999/5/EC būtiskajām prasībām un citiem ar to saistītajiem noteikumiem.

**MT:** Hawnekk, Dialogic Corporation, jiddikjara li dan ITE jikkonforma mal-ħtiġijiet essenzjali u ma provvedimenti oħrajn relevanti li hemm fid-Direttiva 1999/5/EC.

**NL:** Hierbij verklaart Dialogic Corporation dat het toestel ITE in overeenstemming is met de essentiële eisen en de andere relevante bepalingen van richtlijn 1999/5/EG.

**NO:** Dialogic Corporation erklærer herved at utstyret ITE er i samsvar med de grunnleggende krav og øvrige relevante krav i direktiv 1999/5/EF.

**PL:** Dialogic Corporation niniejszym oświadcza, że ITE spełnia wszystkie istotne wymagania i odpowiednie ustalenia dyrektywy 1999/5/EC.

**PT:** Dialogic Corporation declara que este ITE está conforme com os requisitos essenciais e outras disposições da Directiva 1999/5/CE.

**SL:** Dialogic Corporation izjavlja, da je ta ITE v skladu z bistvenimi zahtevami in ostalimi relevantnimi določili direktive 1999/5/ES.

**SK:** Dialogic Corporation týmto vyhlasuje, že ITE spĺňa základné požiadavky a všetky príslušné ustanovenia Smernice 1999/5/ES.

**SV:**Härmed intygar Dialogic Corporation att denna ITE står i överensstämmelse med de väsentliga egenskapskrav och övriga relevanta bestämmelser som framgår av direktiv 1999/5/EG.

### Product Environmental Information

In August 2005, the European Union Directive on Waste Electrical and Electronic Equipment (2002/96/EC) and its amendment (2003/108/EC), collectively known as the WEEE Directive, came into force throughout most of the European Union. This Dialogic product comes within the scope of the WEEE Directive.

We are confident that this product will provide you with many years of reliable service. Ultimately, a time may come when the product will no longer meet your needs or will become un-economical to repair. It is at that stage that we ask for your co-operation in recycling this product in the spirit of the WEEE directive.

While Dialogic has taken great care to minimize the environmental burden of this product by careful design and manufacturing, we ask you to help us to further minimize the environmental burden of this product by recycling it. Please do not dispose of this product through municipal or general waste systems because it contains materials that can be economically recycled.

Like all electrical and electronic equipment, including televisions and computers, it may contain small amounts of materials which could lead to environmental damage. To minimize any environmental damage we ask you to have this product recycled by:

- bringing it to the recycling collection point in your company
- by handing it into the store where you are purchasing the replacement
- by delivering it to a local bring-center in your area.

No charge can be imposed on you for this recycling service in the European Union as Dialogic has paid for recycling this product when it was placed on the market. These are requirements of the WEEE Directive. We thank you in advance for your cooperation and for working with Dialogic to protect our environment.



## Power consumption

**WARNING:** Check that power supply will not be overloaded. Maximum power consumption of the board is stated in [Technical Specifications](#) on page 44. The user should check that the total power drawn by the host computer, the Dialogic® Diva® Media Board and any other peripherals, must not exceed the capability of the host Power Supply Unit. The Diva Media Board does not draw power from the ISDN network.

---

## User/Installer instructions

Dialogic® Diva® Media Board (internal models only)

## Important safety considerations when installing into a host computer system

**WARNING:** The telephones cord(s) must remain disconnected from the telecommunications system until the Dialogic® Diva® Media Board has been properly installed within the host which provides the necessary protection of the operator.



Proper installation of the telecommunication card requires that the Diva Media Board is screwed to the metal backplate of the PC. This ensures proper grounding, which is necessary for your safety.

If it is subsequently desired to open the host equipment for any reason, the telephones cord(s) must be disconnected prior to effecting access to the telecommunications Diva Media Board.

---

**WARNING:** Never install telephone jacks in wet locations.



Never touch non-insulated telephone wires or terminals unless the telephone line has been disconnected at the network interface.

Use caution when installing or modifying telephone lines.

---



## Installation within a spare slot position

**WARNING:** It is essential that, when other option cards are introduced which use or generate a hazardous voltage, the minimum creepages and clearances specified in the table below are maintained.  Suitable user protection to ensure compliance with EN 60950 should be present on the card. A hazardous voltage is one which exceeds 42.4 V peak ac or 60 V dc. If you have any doubt, seek advice from a competent engineer before installing other Dialogic® Diva® Media Boards into the host equipment.

The equipment must be installed such that with the exception of the connections to the host, clearance and creepage distances shown in the table below are maintained between the Dialogic® Diva® Media Board and any other assemblies which use or generate a voltage shown in the table below.

Clearance X mm	Creepage Y mm	Voltage used or generated by other parts of the host or expansion card Vrms or Vdc
2.0	2.4 (3.8)	up to 50
2.6	3.0 (4.8)	up to 125
4.0	5.0 (8.0)	up to 250
4.0	6.4 (10.0)	up to 300

The larger distance shown in brackets applies where the local environment within the host is subject to conductive pollution or dry non-conductive pollution which could become conductive due to condensation. Failure to maintain these minimum distances would invalidate the approval.

The clearance distance X is the shortest distance in air between two points. The creepage path Y (along surfaces) is the shortest distance between the same two points.

## Regulatory information for Australia

Dialogic is required to provide the following information as a condition of the telecommunications conformity of Dialogic® telecommunications products. You may also be responsible for meeting requirements other than those outlined in this document.

**Note:** Failure to meet the requirements listed may render the products non-compliant, with the user liable to significant penalties under the Telecommunications Act.

---

**WARNING:**



This customer equipment is to be installed and maintained by service personnel as defined by AS/NZS 60950.1:2003 Service Personnel. It may be hazardous if your computer is not properly plugged in and grounded.

---

---

**CAUTION:**



This equipment must be installed and serviced by qualified personnel. No user accessible parts inside.

---

---

**IMPORTANT:** This equipment will be inoperable when mains power fails.



- 
- This customer equipment shall only be installed in a PC that requires the use of a tool to gain access to internal parts (e.g., this customer equipment must not be installed in a PC with a "flip lid").
  - Proper installation of the Dialogic® Diva® Media Board requires that it is screwed to the metal backplate of the computer. This ensures proper grounding, which is necessary for safety purposes.
  - This customer equipment may only be installed in host equipment where there is at least 2 mm of air gap between the customer equipment and adjacent boards (PCBs).
  - Only compliant line cord set(s) shall be used as replacements with this customer equipment.

These products shall be used in a manner that complies with the technical standards ACA TS 001 and ACA TS 002:

- The application software shall answer an incoming call by seizing the line at least 2 seconds after the start of an application of ring signal from a PSTN. A maximum time of 15 seconds is recommended.

- The application software shall comply with the following requirements before the commencement of dialing:
  - When dial tone detection is enabled, the application software may commence dialing after the presence of dial tone is validated.
  - If dial tone detection is not enabled or if dial tone is not detected, the application software shall commence dialing no less than 2 seconds after the line is seized.
- A total of 10 call attempts are allowed to a telephone number, with a minimum period of 2 seconds between calls. If the call does not connect after 10 attempts, 30 minutes must expire before automatic redialing may be initiated.
- These products must connect to the telecommunications network only by means of cables that meet applicable ACA standards and telecommunications conformity.
- These products must only be used in a data terminal equipment (DTE), e.g., computer, that has a screw-down cover or lid. Because unsafe voltages (TNV) exist on these products, disconnect the product from the telephone line while the cover of the DTE is removed.
 

**Note:** This does not apply to Dialogic® Diva® V-xPRI PCIe HS and V-xPRI PCIe FS Media Boards.
- These products will not automatically put the channel back to the on-hook state when the calling party hangs up. The application is tasked to handle this function on the detection of a disconnect tone or loop current drop.

## Regulatory information for Japan

Product	Certificate Number
Diva BRI-2 Diva UM-BRI-2	CD-02-0870JP
Diva 4BRI-8 Diva UM-BRI-2	C01-0472JP L01-0152
Diva PRI/E1/T1-CTI Diva PRI/E1/T1-8	CD05-0558001
Diva PRI/T1-24 Diva PRI/T1-24 PCIe	CD05-0557001
Diva V-2PRI	CD06-0488001
Diva V-4PRI	CD06-0489001
Diva Analog-4 Diva Analog-8 Diva UM-Analog-4 Diva UM-Analog-8	A05-0055003

## Suppliers Declaration of Conformity

The suppliers declaration of conformity are updated constantly. An extract form the complete list can be found on the following pages. The complete list is available on the Dialogic web site under [www.dialogic.com/declarations](http://www.dialogic.com/declarations).

	<h2>Declaration of Conformity</h2>
	No: D0013 Revision 01

The equipment described below is declared to be in conformity with the following applicable national and international standards. The conformity is valid ONLY when the equipment is used in a manner consistent with the manufacturer's recommendations and the reference documents.

**Equipment Type(s):** Diva BRI-2FX

Document No / Edition /Date	Title
IEC 60950 – 3 Edition (1999)	Safety of Information Technology Equipment
EN 60950-1:2001	Safety of Information Technology Equipment
FCC, 47 CFR Part 15, Class B digital device	Radio Frequency Devices - Subpart B - Unintentional Radiators
ICES-003 Issue 4 - Feb 2004, Class B	Interference-Causing Equipment Standards - Digital Apparatus
EN 55022: 1998, Class B Limit	Information Technology Equipment - Radio Disturbance Characteristics
EN 55024: 1998	Information Technology Equipment - Immunity Characteristics
47 CFR part 68, TIA/EIA/IS-968	Technical Requirements for Connection of Terminal Equipment to the Telephone Network
CS-03 Issue 8 Part VI	Specification for Terminal Equipment, Terminal Systems, Network Protection Devices, Connection Arrangements
TBR3: Nov 95, A1, Dec 97	Attachment requirements for terminal equipment to connect to a ISDN using ISDN basic access
AS/NZS 60950: 2000, A1: 2003	Safety of Information Technology Equipment
AS/ACIF S031: 2001	Requirements for ISDN Basic Access Interface
<b>Additional information:</b>	
Australia test reports:	Fujitsu/Siemens report # CER-EIC01-0005+E01, dated 28/06/2001 covers EN55022
	Nemko report # E865295AU1, dated 29/08/2006 covers AS/NZS 60950
	Elcon internal report, dated 16/11/2001 and TBR3 layer 1, 2, 3 report # 01/02530/1/2 from Deutsche Telekom AG, dated 31/05/2001 covers AS/ACIF S031

#### Regions:

European Economic Area (EEA): Dialogic Corporation (address below) declares the equipment in compliance with the essential requirements of EC Council Directives: 1999/5/EC - R&TTE; 2006/95/EC - Safety/LVD; 89/336/EEC - EMC
USA: Dialogic Corporation (address below) make this SDoC as Responsible Party for equipment registered with ACTA as number: Reg. no: E3SCAN-40181-XD-N
Canada: Dialogic Corporation (address below) is the Declaring Party for equipment registered with Industry Canada as number: IC: 885E-803007
Australia / New Zealand: Supplier Code N964 [Dialogic Pty Ltd., Level 12, 1 Pacific Highway North Sydney NSW 2060] ACN: 064 824 899
Any other region where the Regulatory Requirements are satisfied by compliance to the standards declared above.

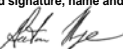
This Declaration of Conformity is issued by Dialogic Corporation, which is solely responsible for the declared compliance.	
<b>Company Address:</b>  Dialogic Corporation 9800 Cavendish 5 <sup>th</sup> floor Montreal, Quebec Canada, H4M 2V9	<b>Authorized signature, name and function:</b>    <b>Gaetan Hogue - Approvals Manager</b> Date: 25, January, 2007

Dialogic Distribution Limited, our location in Europe operates from:  
 Unit 4034 Kingswood Avenue Citywest Business Campus, Saggart, Co. Dublin, Ireland.

Copies of this Declaration of Conformity may be downloaded at <http://www.dialogic.com/declarations>



## Declaration of Conformity

NO: D0066

Revision 01

The equipment described below is declared to be in conformity with the following applicable national and international standards. The conformity is valid ONLY when the equipment is used in a manner consistent with the manufacturer's recommendations and the reference documents.

**Equipment Type(s):** Diva BRI-CTI

Document No / Edition /Date	Title
IEC 60950 – 3 Edition (1999)	Safety of Information Technology Equipment
EN 60950-1: 2001	Safety of Information Technology Equipment
FCC, 47 CFR Part 15, Class B digital device	Radio Frequency Devices - Subpart B - Unintentional Radiators
ICES-003 Issue 4 - Feb 2004, Class B	Interference-Causing Equipment Standards - Digital Apparatus
EN 55022: 1998, Class B Limit	Information Technology Equipment - Radio Disturbance Characteristics
EN 55024: 1998	Information Technology Equipment - Immunity Characteristics
47 CFR part 68, TIA/EIA/IS-968	Technical Requirements for Connection of Terminal Equipment to the Telephone Network
CS-03 Issue 8 Part VI	Specification for Terminal Equipment, Terminal Systems, Network Protection Devices, Connection Arrangements
TBR3: Nov 95, A1: Dec 97	Attachment requirements for terminal equipment to connect to a ISDN using ISDN basic access
AS/NZS 60950: 2000, A1: 2003	Safety of Information Technology Equipment
AS/ACIF S031: 2001	Requirements for ISDN Basic Access Interface

Additional information:	
Australia test reports:	Fujitsu/Siemens report # CER+EIC01-0005+E01, dated 28/06/2001 covers EN55022 Memko report # 6365236AU1, dated 28/06/2006 covers AS/NZS 60950 Ericc internal report, dated 18/11/2001 and TBR3 layer 1, 2, 3 report # 01.025301/1Z from Deutsche Telekom AG, dated 31/05/2001 covers AS/ACIF S031

## Regions:

European Economic Area (EEA): Dialogic Corporation (address below) declares the equipment in compliance with the essential requirements of EC Council Directives: 1999/5/EC - R&TTE; 2006/95/EC - Safety/LVD; 2004/108/EC - EMC
USA: Dialogic Corporation (address below) make this SDoC as Responsible Party for equipment registered with ACTA as number: Reg. no: E3SCAN-40181-XD-N
Canada: Dialogic Corporation (address below) is the Declaring Party for equipment registered with Industry Canada as number: IC: 885E-803007
Australia: Supplier Code N964 [Dialogic Pty Ltd, Level 12, 1 Pacific Highway North Sydney NSW 2060] ACN: 064 824 899
Any other region where the Regulatory Requirements are satisfied by compliance to the standards declared above.

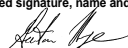
This Declaration of Conformity is issued by Dialogic Corporation, which is solely responsible for the declared compliance.	
<b>Company Address:</b>  Dialogic Corporation 9800 Cavendish 5 <sup>th</sup> floor Montreal, Quebec Canada, H4M 2V9	<b>Authorized signature, name and function:</b>   <b>Gaetan Hogue - Approvals Manager</b> Date: 20, November, 2007

Dialogic Distribution Limited, our location in Europe operates from:  
Unit 4034 Kingswood Avenue Citywest Business Campus, Saggart, Co. Dublin, Ireland.

Copies of this Declaration of Conformity may be downloaded at <http://www.dialogic.com/declarations>

	<b>Declaration of Conformity</b> No.: D0014 Revision 01
---	---

The equipment described below is declared to be in conformity with the following applicable national and international standards. The conformity is valid ONLY when the equipment is used in a manner consistent with the manufacturer's recommendations and the reference documents.

**Equipment Type(s):** Diva BRI-2

Document No / Edition /Date	Title
IEC 60950 - 3 Edition (1999)	Safety of Information Technology Equipment
EN 60950-1: 2001	Safety of Information Technology Equipment
FCC, 47 CFR Part 15, Class B digital device	Radio Frequency Devices - Subpart B - Unintentional Radiators
ICES-003 Issue 4 - Feb 2004, Class B	Interference-Causing Equipment Standards - Digital Apparatus
EN 55022: 1998, Class B Limit	Information Technology Equipment - Radio Disturbance Characteristics
EN 55024: 1998	Information Technology Equipment - Immunity Characteristics
47 CFR part 68, TIA/EIA/IS-968	Technical Requirements for Connection of Terminal Equipment to the Telephone Network
CS-03 Issue 8 Part VI	Specification for Terminal Equipment, Terminal Systems, Network Protection Devices, Connection Arrangements
TBR3: Nov 95, A1: Dec 97	Attachment requirements for terminal equipment to connect to a ISDN using ISDN basic access
AS/NZS 60950: 2000, A1: 2003	Safety of Information Technology Equipment
AS/ACIF S031: 2001	Requirements for ISDN Basic Access Interface

<b>Additional information:</b>	
Australia test reports:	Fujitsu/Siemens report # CER+EIC01-0003+E01, dated 28/06/2001 covers EN55022 Nemko report # 6S65285AU1, dated 05/29/2006 covers AS/NZS 60950
	Eicon internal report, dated 16/11/2001 and TBR3 layer 1, 2, 3 report # 01/02530/1Z from Deutsche Telekom AG, dated 31/05/2001 covers AS/ACIF S031

**Regions:**

European Economic Area (EEA): Dialogic Corporation (address below) declares the equipment in compliance with the essential requirements of EC Council Directives: 1999/5/EC - R&TTE: 2006/95/EC - Safety/LVD: 89/336/EEC - EMC
USA: Dialogic Corporation (address below) make this SDoC as Responsible Party for equipment registered with ACTA as number: Reg. no: E3SCAN-40181-XD-N
Canada: Dialogic Corporation (address below) is the Declaring Party for equipment registered with Industry Canada as number: IC: 885E-803007
Australia / New Zealand: Supplier Code N964 [Dialogic Pty Ltd., Level 12, 1 Pacific Highway North Sydney NSW 2060] ACN: 064 824 899
Any other region where the Regulatory Requirements are satisfied by compliance to the standards declared above.

This Declaration of Conformity is issued by Dialogic Corporation, which is solely responsible for the declared compliance.	
<b>Company Address:</b>  Dialogic Corporation 9800 Cavendish 5 <sup>th</sup> floor Montreal, Quebec Canada, H4M 2V9	<b>Authorized signature, name and function:</b>   <b>Gaëlan Hogue - Approvals Manager</b> Date: 25, January, 2007

Dialogic Distribution Limited, our location in Europe operates from:  
 Unit 4034 Kingswood Avenue Citywest Business Campus, Saggart, Co. Dublin, Ireland.

Copies of this Declaration of Conformity may be downloaded at <http://www.dialogic.com/declarations>



## Declaration of Conformity

No: D0015  
Revision 01

The equipment described below is declared to be in conformity with the following applicable national and international standards. The conformity is valid ONLY when the equipment is used in a manner consistent with the manufacturer's recommendations and the reference documents.

Equipment Type(s): Diva 4-BRI

Document No / Edition /Date	Title
IEC 60950 – 3 Edition (1999)	Safety of Information Technology Equipment
EN 60950-1: 2001	Safety of Information Technology Equipment
FCC, 47 CFR Part 15, Class B digital device	Radio Frequency Devices - Subpart B - Unintentional Radiators
ICES-003 Issue 4 - Feb 2004, Class B	Interference-Causing Equipment Standards - Digital Apparatus
EN 55022: 1998, Class B Limit	Information Technology Equipment - Radio Disturbance Characteristics
EN 55024: 1998	Information Technology Equipment - Immunity Characteristics
47 CFR part 68, subpart D	Technical Requirements for Connection of Terminal Equipment to the Telephone Network
CS-03 Issue 8 Part VI	Specification for Terminal Equipment, Terminal Systems, Network Protection Devices, Connection Arrangements
TBR3, Nov 95, A1: Dec 97	Attachment requirements for terminal equipment to connect to a ISDN using ISDN basic access
AS/NZS 60950: 2000, A1: 2003	Safety of Information Technology Equipment
AS/ACIF S031: 2001	Requirements for ISDN Basic Access Interface
<b>Additional information:</b>	
Australia test reports:	Fujitsu/Siemens report # EIC0E004-1, dated 22/03/2001 covers EN55022 Nemko report # 636529SAU1, dated 05/29/2006 covers AS/NZS 60950
	Eicon internal report, dated 16/11/2001 and TBR3 layer 1, 2, 3 report # 01/017802/UVZ from Deutsche Telekom AG, dated 27/04/2001 covers AS/ACIF S031

## Regions:

European Economic Area (EEA): Dialogic Corporation (address below) declares the equipment in compliance with the essential requirements of EC Council Directives: 1999/5/EC - R&TTE: 2006/95/EC - Safety/LVD: 89/336/EEC – EMC
USA: Dialogic Corporation (address below) make this SDoC as Responsible Party for equipment registered with ACTA as number: Reg. no: E3SCAN-40181-XD-N
Canada: Dialogic Corporation (address below) is the Declaring Party for equipment registered with Industry Canada as number: IC: 885E-803008
Australia / New Zealand: Supplier Code N964 [Dialogic Pty Ltd. Level 12, 1 Pacific Highway North Sydney NSW 2060] ACN: 064 824 899
Any other region where the Regulatory Requirements are satisfied by compliance to the standards declared above.

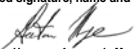
This Declaration of Conformity is issued by Dialogic Corporation, which is solely responsible for the declared compliance.	
<b>Company Address:</b> Dialogic Corporation 9800 Cavendish 5 <sup>th</sup> floor Montreal, Quebec Canada, H4M 2V9	<b>Authorized signature, name and function:</b>  <b>Gaetan Hogue - Approvals Manager</b> Date: 25, January, 2007

Dialogic Distribution Limited, our location in Europe operates from:  
Unit 4034 Kingswood Avenue Citywest Business Campus, Saggart, Co. Dublin, Ireland.

Copies of this Declaration of Conformity may be downloaded at <http://www.dialogic.com/declarations>



	<h2 style="margin: 0;">Declaration of Conformity</h2> <p style="margin: 0;">No: D0017 Revision 01</p>
---	---

The equipment described below is declared to be in conformity with the following applicable national and international standards. The conformity is valid ONLY when the equipment is used in a manner consistent with the manufacturer's recommendations and the reference documents.

**Equipment Type(s):** Diva PRI/E1/T1-8  
Diva PRI/E1/T1-CTI

Document No / Edition /Date	Title
IEC 60950-1: 2001	Safety of Information Technology Equipment
UL/CSA 60950-1 – 1 <sup>st</sup> Edition (2003)	Safety of Information Technology Equipment
EN 60950-1: 2001	Safety of Information Technology Equipment
FCC, 47 CFR Part 15, Class B digital device	Radio Frequency Devices - Subpart B - Unintentional Radiators
ICES-003 Issue 4 - Feb 2004, Class B	Interference-Causing Equipment Standards - Digital Apparatus
EN 55022: 1998, Class B Limit	Information Technology Equipment - Radio Disturbance Characteristics
EN 55024: 1998	Information Technology Equipment - Immunity Characteristics
47 CFR part 68, TIA-968-A	Technical Requirements for Connection of Terminal Equipment to the Telephone Network
CS-03 Issue 8 Part VI	Specification for Terminal Equipment, Terminal Systems, Network Protection Devices, Connection Arrangements
TBR4: Nov 95, A1: Dec 97	Attachment requirements for terminal equipment to connect to an ISDN using ISDN primary rate access
AS/NZS 60950: 2000, A1: 2003	Safety of Information Technology Equipment
AS/ACIF S038: 2001	Requirements for ISDN Primary Rate Access Interface

<b>Additional information:</b>	
Australia test reports:	Fujitsu/Siemens report CER-EIC03-0001+E01, dated 23/06/2003 covers EN55022 Nemko report 6S6529SAU1, dated 29/05/2006 covers AS/NZS 60950
	Eicon internal report, dated 16/11/2001 and TBR4 layer 1 from Cetecom, dated 28/06/2005 and layer 2, 3 report 98/164HJ from Deutsche Telekom AG, dated 30/07/1998 covers AS/ACIF S038

#### Regions:

European Economic Area (EEA): Dialogic Corporation (address below) declares the equipment in compliance with the essential requirements of EC Council Directives: 1999/5/EC - R&TTE: 2006/95/EC - Safety/LVD: 89/336/EEC - EMC
USA: Dialogic Corporation (address below) make this SDoC as Responsible Party for equipment registered with ACTA as number: US: E3SDDNAN800-808
Canada: Dialogic Corporation (address below) is the Declaring Party for equipment registered with Industry Canada as number: IC: 885E-803002
Australia / New Zealand: Supplier Code N964 [Dialogic Pty Ltd., Level 12, 1 Pacific Highway North Sydney NSW 2060] ACN: 064 824 899
Any other region where the Regulatory Requirements are satisfied by compliance to the standards declared above.

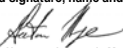
This Declaration of Conformity is issued by Dialogic Corporation, which is solely responsible for the declared compliance.	
<b>Company Address:</b>  Dialogic Corporation 9800 Cavendish 5 <sup>th</sup> floor Montreal, Quebec Canada, H4M 2V9	<b>Authorized signature, name and function:</b>   <b>Gaetan Hogue - Approvals Manager</b> Date: 25, January, 2007

Dialogic Distribution Limited, our location in Europe operates from:  
Unit 4034 Kingswood Avenue Citywest Business Campus, Saggart, Co. Dublin, Ireland.

Copies of this Declaration of Conformity may be downloaded at <http://www.dialogic.com/declarations>



## Declaration of Conformity

No: D0016  
Revision 01

The equipment described below is declared to be in conformity with the following applicable national and international standards. The conformity is valid ONLY when the equipment is used in a manner consistent with the manufacturer's recommendations and the reference documents.

**Equipment Type(s):** Diva PRI/E1-30, Diva V-PRI/E1-30  
Diva PRI/T1-24, Diva V-PRI/T1-24

Document No / Edition /Date	Title
IEC 60950-1: 2001	Safety of Information Technology Equipment
UL/CSA 60950-1 – 1 <sup>st</sup> Edition (2003)	Safety of Information Technology Equipment
EN 60950-1: 2001	Safety of Information Technology Equipment
FCC, 47 CFR Part 15, Class B digital device	Radio Frequency Devices - Subpart B - Unintentional Radiators
ICES-003 Issue 4 - Feb 2004, Class B	Interference-Causing Equipment Standards - Digital Apparatus
EN 55022: 1998, Class B Limit	Information Technology Equipment - Radio Disturbance Characteristics
EN 55024: 1998	Information Technology Equipment - Immunity Characteristics
47 CFR part 68, TIA-968-A	Technical Requirements for Connection of Terminal Equipment to the Telephone Network
CS-03 Issue 8 Part VI	Specification for Terminal Equipment, Terminal Systems, Network Protection Devices, Connection Arrangements
TBR4: Nov 95, A1: Dec 97	Attachment requirements for terminal equipment to connect to an ISDN using ISDN primary rate access
AS/NZS 60950: 2000.A1: 2003	Safety of Information Technology Equipment
AS/ACIF S038: 2001	Requirements for ISDN Primary Rate Access Interface

**Additional information:**

Australia test reports:	Fujiitsu/Siemens report EMI+EIC02-0002+E01, dated 07/04/2001 covers EN55022 Nemko report 6S65235AU1, dated 05/29/2006 covers AS/NZS 60950
NZ test report	Eicon internal report, dated 16/11/2001 and TBR4 layer 1 from Cetecom, dated 28/06/2005 and layer 2, 3 report 98/164/HJ from Deutsche Telekom AG, dated 30/07/1998 covers AS/ACIF S038 Nemko report 5T44740, dated May 11, 2005 covers Layer 3 supplementary testing

**Regions:**

European Economic Area (EEA): Dialogic Corporation (address below) declares the equipment in compliance with the essential requirements of EC Council Directives: 1999/5/EC - R&TTE: 2006/95/EC - Safety/LVD: 89/336/EEC – EMC
USA: Dialogic Corporation (address below) make this SDoC as Responsible Party for equipment registered with ACTA as number: US: E3SDDNAN800-810
Canada: Dialogic Corporation (address below) is the Declaring Party for equipment registered with Industry Canada as number: IC: 885E-803003
Australia / New Zealand: Supplier Code N964 [Dialogic Pty Ltd. Level 12, 1 Pacific Highway North Sydney NSW 2060] ACN: 064 824 899
Any other region where the Regulatory Requirements are satisfied by compliance to the standards declared above.

This Declaration of Conformity is issued by Dialogic Corporation, which is solely responsible for the declared compliance.

<b>Company Address:</b>  Dialogic Corporation 9800 Cavendish 5 <sup>th</sup> floor Montreal, Quebec Canada, H4M 2V9	<b>Authorized signature, name and function:</b>   <b>Gaetan Hogue - Approvals Manager</b> Date: 25, January, 2007
--	--

Dialogic Distribution Limited, our location in Europe operates from:  
Unit 4034 Kingswood Avenue Citywest Business Campus, Saggart, Co. Dublin, Ireland.

Copies of this Declaration of Conformity may be downloaded at <http://www.dialogic.com/declarations>

	<b>Declaration of Conformity</b> No: D0018 Revision 01
---	--

The equipment described below is declared to be in conformity with the following applicable national and international standards. The conformity is valid ONLY when the equipment is used in a manner consistent with the manufacturer's recommendations and the reference documents.

**Equipment Type(s):** Diva 2-PR1, V-2PR1  
 Diva 4-PR1, V-4PR1

Document No / Edition /Date	Title
IEC 60950-1: 2001	Safety of Information Technology Equipment
UL/CSA 60950-1 – 1 <sup>st</sup> Edition (2003)	Safety of Information Technology Equipment
EN 60950-1: 2001	Safety of Information Technology Equipment
FCC, 47 CFR Part 15, Class B digital device	Radio Frequency Devices - Subpart B - Unintentional Radiators
ICES-003 Issue 4 - Feb 2004, Class B	Interference-Causing Equipment Standards - Digital Apparatus
EN 55022: 1998, Class B Limit	Information Technology Equipment - Radio Disturbance Characteristics
EN 55024: 1998	Information Technology Equipment - Immunity Characteristics
TIA-968-A: Oct 2002, A1: July 2003, A2: Jan 2003, A3: Dec 9, 2004	Technical Requirements for Connection of Terminal Equipment to the Telephone Network
CS-03 Issue 9 Part VI: Nov 2004	Specification for Terminal Equipment, Terminal Systems, Network Protection Devices, Connection Arrangements
TBR4: Nov 95, A1: Dec 97	Attachment requirements for terminal equipment to connect to an ISDN using ISDN primary rate access
AS/NZS 60950: 2000, A1: 2003	Safety of Information Technology Equipment
AS/ACIF S038: 2001	Requirements for ISDN Primary Rate Access Interface

<b>Additional information:</b>	
Australia test reports:	Fujitsu/Siemens report CER+EIC04-0004+E01, dated 26/10/2004 covers EN55022 Fujitsu/Siemens report CER+EIC06-0005+S01, dated 11/07/2004 covers AS/NZS 60950 Eicon internal report, dated 19/01/2006 and TBR4 layer 1 report # 3-4143-1-2/04 from Cetecon, dated 03/11/2004 and layer 2, 3 report 98/164/HJ from Deutsche Telekom AG, dated 30/07/1998 covers AS/ACIF S038

**Regions:**

European Economic Area (EEA): Dialogic Corporation (address below) declares the equipment in compliance with the essential requirements of EC Council Directives: 1999/5/EC - R&TTE: 2006/95/EC - Safety/LVD: 89/336/EEC – EMC
USA: Dialogic Corporation (address below) make this SDoC as Responsible Party for equipment registered with ACTA as number: US: E3SDDNAN800-820
Canada: Dialogic Corporation (address below) is the Declaring Party for equipment registered with Industry Canada as number: IC: 885E-803016
Australia / New Zealand: Supplier Code N964 [Dialogic Pty Ltd., Level 12, 1 Pacific Highway North Sydney NSW 2060] ACN: 064 824 899
Any other region where the Regulatory Requirements are satisfied by compliance to the standards declared above.

This Declaration of Conformity is issued by Dialogic Corporation, which is solely responsible for the declared compliance.	
<b>Company Address:</b> Dialogic Corporation 9800 Cavendish 5 <sup>th</sup> floor Montreal, Quebec Canada, H4M 2V9	<b>Authorized signature, name and function:</b>  Gaélán Hogue - Approvals Manager Date: 25, January, 2007

Dialogic Distribution Limited, our location in Europe operates from:  
 Unit 4034 Kingswood Avenue Citywest Business Campus, Saggart, Co. Dublin, Ireland.

Copies of this Declaration of Conformity may be downloaded at <http://www.dialogic.com/declarations>

**Dialogic**

## Declaration of Conformity

No: D0022  
Revision 01

The equipment described below is declared to be in conformity with the following applicable national and international standards. The conformity is valid ONLY when the equipment is used in a manner consistent with the manufacturer's recommendations and the reference documents.

**Equipment Type(s):** Diva PRI/E1/T1-CTI PCle

Document No / Edition /Date	Title
IEC 60950-1: 2005 (2 <sup>nd</sup> Edition)	Safety of Information Technology Equipment
UL/CSA 60950-1 – 1 <sup>st</sup> Edition (2003)	Safety of Information Technology Equipment
EN 60950-1: 2006	Safety of Information Technology Equipment
FCC, 47 CFR Part 15, Class B digital device	Radio Frequency Devices - Subpart B - Unintentional Radiators
ICES-003 Issue 4 - Feb 2004, Class B	Interference-Causing Equipment Standards - Digital Apparatus
EN 55022: 1998, Class B Limit	Information Technology Equipment - Radio Disturbance Characteristics
EN 55024: 1998	Information Technology Equipment - Immunity Characteristics
TIA-968-A; Oct 2002, A1: July 2003, A2: Jan 2003, A3; Dec: 9, 2004	Technical Requirements for Connection of Terminal Equipment to the Telephone Network
CS-03 Issue 9 Part VI, A2; Apr 2006	Specification for Terminal Equipment, Terminal Systems, Network Protection Devices, Connection Arrangements
TBR4: Nov 95, A1: Dec 97	Attachment requirements for terminal equipment to connect to an ISDN using ISDN primary rate access

**Regions:**

European Economic Area (EEA): Dialogic Corporation (address below) declares the equipment in compliance with the essential requirements of EC Council Directives: 1999/5/EC - R&TTE; 2006/95/EC - Safety;LVD: 89/336/EEC - EMC
USA: Dialogic Corporation (address below) make this SDoC as Responsible Party for equipment registered with ACTA as number: US: E3SDDNAN803-025
Canada: Dialogic Corporation (address below) is the Declaring Party for equipment registered with Industry Canada as number: IC: 885E-803025
Any other region where the Regulatory Requirements are satisfied by compliance to the standards declared above.

This Declaration of Conformity is issued by Dialogic Corporation, which is solely responsible for the declared compliance.	
<b>Company Address:</b>  Dialogic Corporation 9800 Cavendish 5 <sup>th</sup> floor Montreal, Quebec Canada, H4M 2V9	<b>Authorized signature, name and function:</b>   <b>Gaetan Hogue - Approvals Manager</b> Date: 25, January, 2007

Dialogic Distribution Limited, our location in Europe operates from:  
Unit 4034 Kingswood Avenue Citywest Business Campus, Saggart, Co. Dublin, Ireland.

Copies of this Declaration of Conformity may be downloaded at <http://www.dialogic.com/declarations>

	<h2 style="margin: 0;">Declaration of Conformity</h2> <p style="margin: 0;">No: D0021 Revision 02</p>
---	---

The equipment described below is declared to be in conformity with the following applicable national and international standards. The conformity is valid ONLY when the equipment is used in a manner consistent with the manufacturer's recommendations and the reference documents.

**Equipment Type(s):** Diva PRI/E1-30 PCIE, Diva V-PRI/E1-30 PCIE  
Diva PRI/T1-24 PCIE, Diva V-PRI/T1-24 PCIE

Document No / Edition /Date	Title
IEC 60950-1: 2005 (2 <sup>nd</sup> Edition)	Safety of Information Technology Equipment
UL/CSA 60950-1 – 1 <sup>st</sup> Edition (2003)	Safety of Information Technology Equipment
EN 60950-1: 2006	Safety of Information Technology Equipment
EN 55022: 1998, Class B Limit	Information Technology Equipment - Radio Disturbance Characteristics
EN 55024: 1998, A1: 2001	Information Technology Equipment - Immunity Characteristics
FCC, 47 CFR Part 15, Class B digital device	Radio Frequency Devices - Subpart B - Unintentional Radiators
ICES-003 Issue 4 - Feb 2004, Class B	Interference-Causing Equipment Standards - Digital Apparatus
TIA-968-A: Oct 2002, A1: July 2003, A2: Jan 2003, A3: Dec-9, 2004	Technical Requirements for Connection of Terminal Equipment to the Telephone Network
CS-03 Issue 9 Part VI, A2: Apr 2006	Specification for Terminal Equipment, Terminal Systems, Network Protection Devices, Connection Arrangements
TBR4: Nov 95, A1: Dec 97	Attachment requirements for terminal equipment to connect to an ISDN using ISDN primary rate access
AS/NZS 60950: 2000 A1: 2003	Safety of Information Technology Equipment
AS/ACIF S038: 2001	Requirements for ISDN Primary Rate Access Interface

<b>Additional information:</b>	
Australia test reports:	Fujitsu/Siemens report EMC+EIC06-0004+E01, dated 03/08/2006 covers CISPR22 Intertek report 06ST006828, dated 29/03/2007 covers AS/NZS 60950 Eicom internal report, dated 19/03/2007 and TBR4 layer 1 from Catecom, dated 10/11/2006 and layer 2, 3 report 98/1644HJ from Deutsche Telekom AG, dated 30/07/1998 covers AS/ACIF S038

#### Regions:

European Economic Area (EEA): Dialogic Corporation (address below) declares the equipment in compliance with the essential requirements of EC Council Directives: 1999/5/EC - R&TTE: 2006/95/EC - Safety/LVD: 89/336/EEC – EMC
USA: Dialogic Corporation (address below) make this SDoC as Responsible Party for equipment registered with ACTA as number: US: ESSDONAN803-024
Canada: Dialogic Corporation (address below) is the Declaring Party for equipment registered with Industry Canada as number: IC: 885E-803024
Australia / New Zealand: Supplier Code N964 [Dialogic Pty Ltd. Level 12, 1 Pacific Highway North Sydney NSW 2060] ACN: 064 824 899
Any other region where the Regulatory Requirements are satisfied by compliance to the standards declared above.

This Declaration of Conformity is issued by Dialogic Corporation, which is solely responsible for the declared compliance.	
<b>Company Address:</b>  Dialogic Corporation 9800 Cavendish 5 <sup>th</sup> floor Montreal, Quebec Canada, H4M 2V9	<b>Authorized signature, name and function:</b>   <b>Gaetan Hogue - Approvals Manager</b> Date: 16, April, 2007

Dialogic Distribution Limited, our location in Europe operates from:  
Unit 4034 Kingswood Avenue Citywest Business Campus, Saggart, Co. Dublin, Ireland.

Copies of this Declaration of Conformity may be downloaded at <http://www.dialogic.com/declarations>

	<b>Declaration of Conformity</b> No: D0019 Revision 04

The equipment described below is declared to be in conformity with the following applicable national and international standards. The conformity is valid ONLY when the equipment is used in a manner consistent with the manufacturer's recommendations and the reference documents.

**Equipment Type(s):** Diva Analog-2

Document No / Edition /Date	Title
IEC 60950-1: 2001	Safety of Information Technology Equipment
UL/CSA 60950-1 – 1 <sup>st</sup> Edition (2003)	Safety of Information Technology Equipment
EN 60950-1: 2001	Safety of Information Technology Equipment
EN 55022: 1998, Class B Limit	Information Technology Equipment - Radio Disturbance Characteristics
EN 55024: 1998, A1: 2001, A2: 2003	Information Technology Equipment - Immunity Characteristics
FCC, 47 CFR Part 15, Class B digital device	Radio Frequency Devices - Subpart B - Unintentional Radiators
ICES-003 Issue 4 - Feb 2004, Class B	Interference-Causing Equipment Standards - Digital Apparatus
TIA-968-A; Oct 2002, A1: July 2003, A2: Jan 2003 and A3: Dec 9, 2004	Technical Requirements for Connection of Terminal Equipment to the Telephone Network
CS-03 Issue 9 + A2 April 06	Specification for Terminal Equipment, Terminal Systems, Network Protection Devices, Connection Arrangements
TBR21: Jan 98	Attachment requirements for terminal equipment for connection to analogue PSTN
EG 201 121: 2000-02	Terminal equipment (TE); additional requirements for attachments to several European countries
AS/NZS 60950: 2000, A1: 2003	Safety of Information Technology Equipment
AS/ACIF S002: 2001	Analogue interworking and non-interference requirements for Customer Equipment for connection to the Public Switched Telephone Network

**Additional information:**

Australia test reports:	Fujiou/Siemens report # AUS-ETC06-0001+E01, dated 22/05/2006 covers AS/NZS CISPR22 Intertek report # I06ST0006252-02, dated 29/03/2007 covers AS/NZS 60950
	Nemko report # 86616TRFITE, dated 20/06/2007 covers AS/ACIF S002

**Regions:**

European Economic Area (EEA): Dialogic Corporation (address below) declares the equipment in compliance with the essential requirements of EC Council Directives: 1999/5/EC - R&TTE; 2006/95/EC - Safety/LVD; 89/336/EEC - EMC
USA: Dialogic Corporation (address below) make this SDC as Responsible Party for equipment registered with ACTA as number: US: E3SMM02B803-027
Canada: Dialogic Corporation (address below) is the Declaring Party for equipment registered with Industry Canada as number: IC: 885E-803027
Australia: Supplier Code N964 (Dialogic Pty Ltd, Level 12, 1 Pacific Highway North Sydney NSW 2060) ACN: 064 824 899
Any other region where the Regulatory Requirements are satisfied by compliance to the standards declared above.

This Declaration of Conformity is issued by Dialogic Corporation, which is solely responsible for the declared compliance.	
<b>Company Address:</b>	<b>Authorized signature, name and function:</b>
Dialogic Corporation 9800 Cavendish 5 <sup>th</sup> floor Montreal, Quebec Canada, H4M 2V9	 <b>Gaëtan Hogue - Approvals Manager</b> Date: 15, January, 2008

Dialogic Distribution Limited, our location in Europe operates from:  
Unit 4034 Kingswood Avenue Citywest Business Campus, Saggart, Co. Dublin, Ireland.

Copies of this Declaration of Conformity may be downloaded at <http://www.dialogic.com/declarations>

	<b>Declaration of Conformity</b> No: D0020 Revision 03
---	--

The equipment described below is declared to be in conformity with the following applicable national and international standards. The conformity is valid ONLY when the equipment is used in a manner consistent with the manufacturer's recommendations and the reference documents.

**Equipment Type(s):** Diva Analog-4  
Diva Analog-8

Document No / Edition /Date	Title
IEC 60950-1: 2001	Safety of Information Technology Equipment
UL/CSA 60950-1 – 1 <sup>st</sup> Edition (2003)	Safety of Information Technology Equipment
EN 60950-1: 2001	Safety of Information Technology Equipment
EN 55022: 1998, Class B Limit	Information Technology Equipment - Radio Disturbance Characteristics
EN 55024: 1998	Information Technology Equipment - Immunity Characteristics
FCC, 47 CFR Part 15, Class B digital device	Radio Frequency Devices - Subpart B - Unintentional Radiators
ICES-003 Issue 4 - Feb 2004, Class B	Interference-Causing Equipment Standards - Digital Apparatus
47 CFR part 68, T1A/E1A/S-968	Technical Requirements for Connection of Terminal Equipment to the Telephone Network
CS-03 Issue 8 Part 1	Specification for Terminal Equipment, Terminal Systems, Network Protection Devices, Connection Arrangements
TS 103 021: Aug 2003	Access and terminals (AT): Harmonized basic attachment requirements for Terminals for connection to analogue interfaces of the Telephone Networks: Update of the technical contents of TBR21, TBR015, TBR17, EN 301 437
AS/NZS 60950: 2000, A1: 2003	Safety of Information Technology Equipment
AS/ACIF S002: 2001	Analogue interworking and non-interference requirements for Customer Equipment for connection to the Public Switched Telephone Network
<b>Additional information:</b>	
Australia test reports:	Fujitsu/Siemens report CER+EIC04-0005-E01, dated 19/11/2004 covers ENS5022
	Nemko report 4S27613A11, dated 07/10/2004 covers AS/NZS 60950
	Nemko report 4T27513 issue 3, dated 24/11/2004 covers AS/ACIF S002

**Regions:**

European Economic Area (EEA): Dialogic Corporation (address below) declares the equipment in compliance with the essential requirements of EC Council Directives: 1999/5/EC - R&TTE; 2006/95/EC - Safety/LVD; 89/336/EEC - EMC
USA: Dialogic Corporation (address below) make this SDoC as Responsible Party for equipment registered with ACTA as number: US: E3SMM02B800-824
Canada: Dialogic Corporation (address below) is the Declaring Party for equipment registered with Industry Canada as number: IC: 885E-803015
Australia: Supplier Code N964 Dialogic Pty Ltd. Level 12, 1 Pacific Highway North Sydney NSW 2060 ACN: 064 624 899
Any other region where the Regulatory Requirements are satisfied by compliance to the standards declared above.

This Declaration of Conformity is issued by Dialogic Corporation, which is solely responsible for the declared compliance.	
<b>Company Address:</b>	<b>Authorized signature, name and function:</b>
Dialogic Corporation 9800 Cavendish 5 <sup>th</sup> floor Montreal, Quebec Canada, H4M 2V9	 <b>Gaëtan Hogue - Approvals Manager</b> Date: 15, January, 2008

Dialogic Distribution Limited, our location in Europe operates from:  
Unit 4034 Kingswood Avenue Citywest Business Campus, Saggart, Co. Dublin, Ireland.

Copies of this Declaration of Conformity may be downloaded at <http://www.dialogic.com/declarations>



## Declaration of Conformity

No: D0083  
Revision 01

The equipment described below is declared to be in conformity with the following applicable national and international standards. The conformity is valid ONLY when the equipment is used in a manner consistent with the manufacturer's recommendations and the reference documents.

**Equipment Type(s):** Diva Analog-2 PCIe, Diva Analog-4 PCIe, Diva Analog-8 PCIe

Document No / Edition /Date	Title
IEC 60950-1 – 2 <sup>nd</sup> Edition (2005-12)	Safety of Information Technology Equipment CB certificate CA/9996/CSA
CSA 60950-1-03/UL 60950-1	Safety of Information Technology Equipment
EN 60950-1: 2006	Safety of Information Technology Equipment
AS/NZS 60950.1: 2003 +A1; A2, A3	Safety of Information Technology Equipment
EN 55022: 1998, Class B Limit	Information Technology Equipment - Radio Disturbance Characteristics
EN 55024: 1998 + A1 + A2	Information Technology Equipment - Immunity Characteristics
EN 300 386 V1.4.1 (2007-04)	ERM; Telecommunication Network Equipment; EMC
FCC, 47 CFR Part 15, Class B digital device	Radio Frequency Devices - Subpart B - Unintentional Radiators
ICES-003 Issue 4 - Feb 2004, Class B	Interference-Causing Equipment Standards - Digital Apparatus
TIA-968-A + TIA-968 A1 + TIA-968-A2 + TIA-968-A3 + TIA-968-A4 + TIA-968-A5 + TIA-1096-A	Technical Requirements for Connection of Terminal Equipment to the Telephone Network
CS-03 Issue 9, A3 October 06, Part 1	Specification for Terminal Equipment, Terminal Systems, Network Protection Devices, Connection Arrangements
ETSI ES 203 021-1 V2.1.1: 2005, 203-021-2 V2.1.1: 2006, 203-021-3 V2.1.1: 2006	Access and terminals (AT); Harmonized basic attachment requirements for Terminals for connection to analogue interfaces of the Telephone Networks; Update of the technical contents of TBR21, TBR015, TBR17, EN 301 437
AS/ACIF S002: 2005	Analogue interworking and non-interference requirements for Customer Equipment for connection to the Public Switched Telephone Network.
<b>Additional information:</b>	
Australia test reports:	NTS reports 41161-08 and 41162-08, dated 15/08/2008 and 11/09/2008 covers EN55022 CSA report, ACA 163217-2087171 dated 03/09/2008 covers AS/NZS 60950.1 Nemko report 108683-2TRFTTE, dated 10/07/2008 covers AS/ACIF S002

## Regions:

European Economic Area (EEA): Dialogic Corporation (address below) declares the equipment in compliance with the essential requirements of EC Council Directives: 1999/5/EC - R&TTE; 2006/95/EC - Safety/LVD; 2004/108/EC - EMC
USA: Dialogic Corporation (address below) make this SDoC as Responsible Party for equipment registered with ACTA as number: US: E3SM01BDVAA
Canada: Dialogic Corporation (address below) is the Declaring Party for equipment registered with Industry Canada as number: IC: 885E-DIVAA
Australia: Supplier Code N964 [Dialogic Pty Ltd, Level 12, 1 Pacific Highway North Sydney NSW 2060] ACN: 064 824 899
Any other region where the Regulatory Requirements are satisfied by compliance to the standards declared above.

This Declaration of Conformity is issued by Dialogic Corporation, which is solely responsible for the declared compliance.	
<b>Company Address:</b>  Dialogic Corporation 9800 Cavendish 5 <sup>th</sup> floor Montreal, Quebec Canada, H4M 2V9	<b>Authorized signature, name and function:</b>   <b>Gaetan Hogue - Approvals Manager</b> Date: 3, Sep, 2008

Dialogic Distribution Limited, our location in Europe operates from:  
Unit 4034 Kingswood Avenue Citywest Business Campus, Saggart, Co. Dublin, Ireland.

Copies of this Declaration of Conformity may be downloaded at <http://www.dialogic.com/declarations>





## Declaration of Conformity

No: D0086  
Revision 01

The equipment described below is declared to be in conformity with the following applicable national and international standards. The conformity is valid ONLY when the equipment is used in a manner consistent with the manufacturer's recommendations and the reference documents.

**Equipment Type(s):** VPRIHS family  
Diva V-1PRI PCIe HS, Diva V-2PRI PRI PCIe HS, Diva V-4PRI PCIe HS

Document No / Edition /Date	Title
IEC 60950-1 – 2 <sup>nd</sup> Edition (2005-12)	Safety of Information Technology Equipment
UL/CSA 60950-1 – 2 <sup>nd</sup> Edition (2007)	Safety of Information Technology Equipment
EN 60950-1: 2006	Safety of Information Technology Equipment
AS/NZS 60950.1: 2003	Safety of Information Technology Equipment
FCC, 47 CFR Part 15, Class B digital device	Radio Frequency Devices - Subpart B - Unintentional Radiators
ICES-003 Issue 4 - Feb 2004, Class B	Interference-Causing Equipment Standards - Digital Apparatus
EN 300 386 V1.4.1 (2007-04)	ERM, Telecommunication Network Equipment; EMC
EN 55022: 2006, Class B Limit	Information Technology Equipment - Radio Disturbance Characteristics
EN 55024: 1998 +A1 +A2	Information Technology Equipment - Immunity Characteristics
CISPR 22 Ed 5.2 b:2006, Class B Limit	Information Technology Equipment - Radio Disturbance Characteristics
TIA-968-A + TIA-968 A1 + TIA-968-A2 + TIA-968-A3 + TIA-968-A4 + TIA-968-A5 + TIA-1095-A	Technical Requirements for Connection of Terminal Equipment to the Telephone Network
CS-03 Issue 9, A3 April 07, Part xx	Specification for Terminal Equipment, Terminal Systems, Network Protection Devices, Connection Arrangements
TBR4: Nov 95, A1: Dec 97	Attachment requirements for terminal equipment to connect to an ISDN using ISDN primary rate access
TBR 12: 1993/A1:1996	2048 kbit/s Digital Unstructured Leased Lines
TBR 13: 1996	2048 kbit/s Digital Structured Leased Lines
AS/ACIF S016:2001	General Requirements for Customer Equipment Connected to Hierarchical Digital Interfaces - General Requirements for Customer Equipment Connected to Hierarchical Digital Interfaces
AS/ACIF S038:2001	Requirements for ISDN Primary Rate Access Interface - Requirements for ISDN Primary Rate Access Interface
<b>Additional information:</b>	
Australia test reports	CSA test report # 2081787 dated November 2009 covers AS/NZS 60950.1 Nemko test report # 113249-1TRFTE dated 9-Oct-2008 covers TBR4 layer 1 Nemko test report # 114450-1TRFTE dated 28-Oct-2008 covers S038 Nemko test report # 114450TRFTE dated 28-Oct-2008 covers S016

**Regions:**

European Economic Area (EEA): Dialogic Corporation (address below) declares the equipment in compliance with the essential requirements of EC Council Directives : 1999/5/EC - R&TTE : 2006/95/EC - Safety/LVD : 2004/109/EC - EMC
USA : Dialogic Corporation (address below) make this SDoC as Responsible Party for equipment registered with ACTA as number : US: E3SDXNDANVPRHS
Canada : Dialogic Corporation (address below) is the Declaring Party for equipment registered with Industry Canada as number : IC: 885E-VPRHS
Australia: Supplier Code N964 [Dialogic Pty Ltd. Level 12, 1 Pacific Highway North Sydney NSW 2060] ACN: 064 824 899
Any other region where the Regulatory Requirements are satisfied by compliance to the standards declared above.

This Declaration of Conformity is issued by Dialogic Corporation, which is solely responsible for the declared compliance.	
<b>Company Address:</b>  Dialogic Corporation 9800 Cavendish 5 <sup>th</sup> floor Montreal, Quebec Canada, H4M 2V9	<b>Authorized signature, name and function:</b>    Dan Roman - Regulatory Engineer Date: 14, November, 2008

Dialogic Distribution Limited, our location in Europe operates from:  
Unit 4034 Kingswood Avenue Citywest Business Campus, Saggart, Co. Dublin, Ireland.

Copies of this Declaration of Conformity may be downloaded at <http://www.dialogic.com/declarations>

	<h2>Declaration of Conformity</h2> <p>No: D0089 Revision 01</p>
---	---

The equipment described below is declared to be in conformity with the following applicable national and international standards. The conformity is valid ONLY when the equipment is used in a manner consistent with the manufacturer's recommendations and the reference documents.

**Equipment Type(s):** VPRIFS Family

**Models:** Diva V-4PRI PCIe FS and Diva V-8PRI PCIe FS

Document No / Edition /Date	Title
IEC 60950-1 – 2 <sup>nd</sup> Edition (2005-12)	Safety of Information Technology Equipment
UL/CSA 60950-1 – 2 <sup>nd</sup> Edition (2007)	Safety of Information Technology Equipment
EN 60950-1: 2006	Safety of Information Technology Equipment
FCC, 47 CFR Part 15, Class A digital device	Radio Frequency Devices - Subpart B - Unintentional Radiators
ICES-003 Issue 4 – Feb 2004, Class A	Interference-Causing Equipment Standards - Digital Apparatus
EN 300 396 V1.4.1 (2007-04)	ERM: Telecommunication Network Equipment: EMC
EN 55022:2006, Class A Limit	Information Technology Equipment - Radio Disturbance Characteristics
EN 55024: 1998 +A1 +A2	Information Technology Equipment - Immunity Characteristics
CISPR 22 Ed 5.2 b:2006, Class A Limit	Information Technology Equipment - Radio Disturbance Characteristics
TIA-968-A + TIA-968-A1 + TIA-968-A2 + TIA-968-A3 + TIA-968-A4 + TIA-968-A5 + TIA-1096-A	Technical Requirements for Connection of Terminal Equipment to the Telephone Network
CS-03 Issue 9, A3 April 07, Part 2	Specification for Terminal Equipment, Terminal Systems, Network Protection Devices, Connection Arrangements
TBR 12 + A1 ed. 1 (1996-01)	2048 kbit/s Digital Unstructured Leased Line (D0248L)
TBR 13 ed.1 (1996-01)	2048 kbit/s Digital Structured Leased Line (D2048S)
TBR 4 Nov. 95, A1:Dec 97	Attachment requirements for terminal equipment to connect to ISDN using ISDN Primary Rate Access

**Regions:**

European Economic Area (EEA) :Dialogic Corporation (address below) declares the equipment in compliance with the essential requirements of EC Council Directives : 1999/5/EC - R&TTE : 2006/95/EC - Safety/LVD : 2004/108/EC – EMC
USA : Dialogic Corporation (address below) make this SDoC as Responsible Party for equipment registered with ACTA as number : US: E3SXDNANVPRIFS
Canada : Dialogic Corporation (address below) is the Declaring Party for equipment registered with Industry Canada as number : IC: 885E-VPRIFS
Any other region where the Regulatory Requirements are satisfied by compliance to the standards declared above.

This Declaration of Conformity is issued by Dialogic Corporation, which is solely responsible for the declared compliance.	
<p><b>Company Address:</b></p> <p>Dialogic Corporation 9800 Cavendish 5<sup>th</sup> floor Montreal, Quebec Canada, H4M 2V9</p>	<p><b>Authorized signature, name and function:</b></p>  <p><b>Dan Roman - Regulatory Engineer</b> Date: 6-May-2009</p>

Dialogic Distribution Limited, our location in Europe operates from:  
Unit 4034 Kingswood Avenue Citywest Business Campus, Saggart, Co. Dublin, Ireland.

Copies of this Declaration of Conformity may be downloaded at <http://www.dialogic.com/declarations>

## Customer Service

Dialogic provides various options and arrangements for obtaining technical support for your Dialogic® product. We recommend that you use the Dialogic® Diva® Support Tools first before contacting your Dialogic supplier. Also, we suggest that you visit the Dialogic® Services & Support site, as it includes detailed information about a variety of topics. In the unusual case that neither your supplier nor the information on the Services & Support site is able to adequately address your support issue, you can contact Dialogic Customer Support.

For more information see:

- [Dialogic® Diva® Support Tools](#)
- [Dialogic Services & Support web site](#)
- [Dialogic Corporation Customer Support](#)

### Dialogic® Diva® Support Tools

If an issue occurs during the operation of your Dialogic® Diva® product, use the following Dialogic® Diva® Support Tools (only for Windows® operating systems):

- Dialogic® Diva® Line Test: With the Diva Line Test tool, you can test your hardware and perform simple phone test calls, call transfers, or basic inbound and outbound calls.
- Dialogic® Diva® Diagnostics: With the Diva Diagnostics tool, you can write traces for each Dialogic® Diva® Media Board or driver into a file.
- Dialogic® Diva® Management tool: With the Diva Management tool, you can view the current status of the connected lines, the active connections, and the history of the connections.

For more information about the tools, see the respective online help files.

If you cannot address the issue through use of these tools, contact your Dialogic supplier.

### Dialogic Services & Support web site

If your supplier is unable to help you to address your issue, you can visit the Services & Support web site. There, you get access to:

- detailed information about the Dialogic® Pro™ Services (1,3, or 5 year 24/7 service contracts) at <http://www.dialogic.com/support/DialogicPro/>
- a help web section for Dialogic® products at <http://www.dialogic.com/support/helpweb>

- a download section, to install the current version of your software at <http://www.dialogic.com/support/downind.asp>
- a training section, with information about webinars as well as online and onsite trainings, at <http://www.dialogic.com/training/default.htm>
- a manuals section, that includes currently available documentation, at <http://www.dialogic.com/manuals/default.htm>
- technical discussion forums about different developer-specific Q&A at <http://www.dialogic.com/forums/category-view.asp>
- the Dialogic Customer Support site. For detailed information about how to contact the Customer Support, see [Dialogic Corporation Customer Support](#) below.

### **Dialogic Corporation Customer Support**

If the information on the Dialogic® Service & Support web site was not sufficient to help you solve your problem, you can contact Dialogic Customer Support.

To provide help, Dialogic Customer Support will likely need from you:

- A debug trace (see Dialogic® Diva® Diagnostics Online Help file - DivaTrace.chm), and
- A copy of your active configuration (see Dialogic® Diva® Configuration Manager Online Help file - DSMain.chm).

See [www.dialogic.com/support/contact](http://www.dialogic.com/support/contact) for details on how to contact Dialogic.

## Dialogic® Diva® Karten Installationsanleitung

Mit den Dialogic® Diva® Karten können Sie über ISDN-Basisanschlüsse ( $S_0$ ), Primärmultiplexanschlüsse ( $S_{2M}$ ) oder Analoganschlüsse schnellste Verbindungen für eine Vielzahl von Anwendungen realisieren. Diese Installationsanleitung beschreibt die Installation und den Anschluss Ihrer Diva Karte, liefert technische Daten der Karte und gibt einen Überblick über die verfügbare Online-Dokumentation.

## Unterstützte Dialogic® Diva® Karten

Die Dialogic® Diva® Produktpalette beinhaltet die folgenden Diva Karten:

### Dialogic® Diva® BRI Karten

Diva BRI Karten sind leistungsstarke und zum Teil aktive ISDN-Karten für den ISDN-Basisanschluss (BRI). Diese Diva Karten unterstützen sowohl analoge als auch digitale Gegenstellen.

#### Diva BRI PCI:

- Diva BRI-CTI
- Diva BRI-2FX
- Diva BRI-2
- Diva 4BRI-8
- Diva UM-BRI-2
- Diva UM-4BRI-8

#### Diva BRI PCIE:

- Diva BRI-2 PCIE
- Diva 4BRI-8 PCIE
- Diva UM-BRI-2 PCIE
- Diva UM-4BRI-8 PCIE

### Dialogic® Diva® PRI und E1 Karten

Diese Diva Karten sind zum Teil aktive Hochleistungs-ISDN-Karten für den ISDN-Primärmultiplexanschluss (PRI) und können sowohl für digitale als auch für analoge Dienste eingesetzt werden.

#### Diva PRI PCI:

- Diva PRI/E1/T1-CTI
- Diva PRI/E1/T1-8
- Diva PRI/E1-30
- Diva UM-PRI/E1-30

#### Diva V-PRI PCI:

- Diva V-PRI/E1-30

#### Diva V-xPRI PCI:

- Diva V-2PRI/E1-60
- Diva V-4PRI/E1-120

### Hinweise für Diva V-xPRI PCIe:

- Die Abkürzung HS steht für "half size" (halbe Größe). Die genauen Abmessungen finden Sie auf Seite 118. Diese Karten können in einigen Ländern mit dem Gerätetypnamen "VPRIHS" zugelassen sein.
- Die Abkürzung FS steht für "full size" (volle Größe). Die genauen Abmessungen finden Sie auf Seite 119. Diese Karten können in einigen Ländern mit dem Gerätetypnamen "VPRIFS" oder mit den Modellnamen "Diva V-4PRIFS" und "Diva V-8PRIFS" zugelassen sein.

#### Divo PRI PCIe:

- Diva PRI/E1/T1-CTI PCIe
- Diva PRI/E1-30 PCIe
- Diva UM-PRI/E1-30 PCIe

#### Divo V-PRI PCIe:

- Diva V-PRI/E1-30 PCIe

#### Divo V-xPRI PCIe:

- Diva V-1PRI/E1/T1-30 PCIe HS
- Diva V-2PRI/E1/T1-60 PCIe HS
- Diva V-4PRI/E1/T1-120 PCIe HS
- Diva V-4PRI/E1/T1-120 PCIe FS
- Diva V-8PRI/E1/T1-240 PCIe FS

### Dialogic® Diva® Analogkarten

Divo Analogkarten können über RJ-10- oder RJ-45-Standardanschlüsse an analoge Telefonanlagen oder das öffentliche analoge Netz angeschlossen werden. Aufgrund von High-Performance Media Processing Funktionalitäten kann die Divo Analog die Systemleistung verbessern.

#### Divo Analog PCI:

- Diva Analog-2
- Diva Analog-4
- Diva Analog-8
- Diva UM-Analog-2
- Diva UM-Analog-4
- Diva UM-Analog-8

#### Divo Analog PCIe:

- Diva Analog-2 PCIe
- Diva Analog-4 PCIe
- Diva Analog-8 PCIe
- Diva UM-Analog-2 PCIe
- Diva UM-Analog-4 PCIe
- Diva UM-Analog-8 PCIe

## Unterstützte Betriebssysteme

Dialogic® Diva® Karten unterstützen die folgenden Betriebssysteme:

- Linux (die meisten der bekannten Kernels und Distributionen)
- Microsoft® Windows® 7
- Microsoft® Windows Server® 2008
- Microsoft® Windows Vista®
- Microsoft® Windows Server® 2003
- Microsoft® Windows® XP

**Hinweis:** Dialogic® Diva® BRI und UM-BRI Karten können Sie zusätzlich in einem Computer mit dem Betriebssystem Microsoft® Windows® Small Business Server (SBS) einsetzen. Die Software und Dokumentation für die Microsoft® Windows® Small Business Server finden Sie auf der entsprechenden Microsoft® Windows® Small Business Server CD-ROM.

## Dialogic® Diva® Online-Dokumentation

Die Diva Online-Dokumentation ist mit den Treibern der Dialogic® Diva® System Release Software oder auf der Dialogic Internetseite unter: <http://www.dialogic.com/manuals/default.htm> verfügbar. Die Online-Dokumentation beschreibt die Installation der Diva System Release Software, deren Leistungsmerkmale und deren Konfigurations-, Diagnose- und Testprogramme.

## Allgemeine Sicherheitshinweise

Die folgenden Sicherheitshinweise dienen Ihrer persönlichen Sicherheit und schützen den Computer und die Dialogic® Diva® Karte sowie die Arbeitsumgebung vor möglichen Schäden.

### **WARNUNG Alle Dialogic® Diva® Karten**



Computer, in denen Diva Karten eingesetzt werden, müssen den CE-Richtlinien entsprechen, um Gesundheitsschäden und Schäden am Computer und an der Diva Karte zu vermeiden.

Ziehen Sie das analoge oder ISDN-Kabel aus dem Computer, bevor Sie das Gehäuse Ihres Computers für die Installation Ihrer Diva Karte oder aus einem anderen Grund abnehmen, um Gesundheits- und Materialschäden zu vermeiden.

Achten Sie darauf, die Metallschiene der Diva Karte zu verschrauben, so dass sie fest mit dem Computergehäuse verbunden ist. Dadurch wird die richtige Erdung sichergestellt und somit Gesundheits- und Materialschäden vermieden.

Installieren Sie ISDN- oder TAE-Anschlussbuchsen nie in feuchter Umgebung.

Berühren Sie unter keinen Umständen nicht isolierte Teile von Telefonkabeln oder Telefonanlagen außer wenn die Telefonleitung von der Netzwerkschnittstelle getrennt wurde.

Seien Sie beim Installieren oder Modifizieren von Telefonleitungen vorsichtig.

Telefongesellschaften warnen vor Überspannungen, typischerweise durch Blitzeinschläge. Diese können sehr schädlich für Apparate sein können, die an Wechselspannungen angeschlossen sind. Das Benutzen von einem Überspannungsschutz an der Wechselstromleitung wird empfohlen.

### **Dialogic® Diva® BRI und PRI Media Boards, außer Dialogic® Diva® V-xPRI PCIe HS und V-xPRI PCIe FS**

Bei BRI und PRI Signalen kann Telefonnetzwerkspannung anliegen. Deshalb sollten ISDN BRI, ISDN PRI und E1 Leitungen nur von befugtem Servicepersonal installiert und Instand gehalten werden. Das betrifft besonders Installationen in den USA und Australien. Nicht sachgerecht angeschlossene und geerdete Computer, können Gesundheits- und Materialschäden verursachen.



**WARNUNG****Dialogic® Diva® V-xPRI PCIe HS und V-xPRI PCIe FS**

Bei Diva V-xPRI PCIe HS und V-xPRI PCIe FS liegt keine Telefonnetzwerkspannung an, da sie mit einer Schutzkleinspannung (SELV) betrieben werden.

**Dialogic® Diva® V-2PRI PCI, V-4PRI PCI, V-4PRI FS PCIe und V-8PRI FS PCIe**

Divas V-2PRI und V-4PRI Karten können ca. 20 Watt Leistung benötigen.

Divas V-4PRI FS PCIe und V-8PRI FS PCIe Karten können ca. 24 Watt Leistung benötigen.

Wenn Sie mehrere dieser Diva Karten in Ihrem System installiert haben, kann die Stromversorgung überlastet werden. Stellen Sie sicher, dass die Stromversorgung nicht überlastet wird und dass Ihr Computer ausreichende Kühlung gewährleistet, um Gesundheits- und Materialschäden zu vermeiden.

**WICHTIG****Dialogic® Diva® BRI und PRI Karten**

Divas BRI und PRI Karten wurden getestet und entsprechen bezüglich der elektromagnetischen Verträglichkeit, der Sicherheit und der Kompatibilität der ISDN-Schnittstelle den Richtlinien in der EU, in Nordamerika und in anderen wichtigen Wirtschaftsräumen. Lesen Sie die entsprechenden Informationen im Kapitel [Zulassungsinformationen](#) auf Seite 122, bevor Sie die Diva Karte installieren und einsetzen.

Die Kabel für die PRI Schnittstellenanschlüsse müssen abgeschirmt sein.

**Dialogic® Diva® PRI PCIe und V-xPRI PCI und PCIe**

Die korrekte Funktionsweise der Diva PRI PCIe und Diva V-xPRI PCI und PCIe Karten kann nur gewährleistet werden, wenn die Diva Karten innerhalb der zugelassenen Betriebstemperatur eingesetzt werden, siehe Seite 112. Wird die Temperatur überschritten, erstellt das System eine Trace-Datei mit den Informationen über die Betriebstemperatur.

**Dialogic® Diva® Analog**

Benutzen Sie nur Kabel mit American Wire Gauge (AWG) Nr. 26 oder höher, um ein korrektes Funktionieren zu gewährleisten.

## Vorbereitungen

Stellen Sie zunächst sicher, dass alle erforderlichen Komponenten zur Installation Ihrer Dialogic® Diva® Karte und der Dialogic® Diva® System Release Software bereitliegen:

Komponente	Beschreibung
Computer	<p>Ihr Computer muss verfügen über:</p> <ul style="list-style-type: none"> <li>• einen freien PCI-Steckplatz für PCI-Bus Karten (für Dialogic® Diva® V-2PRI und V-4PRI Karten gemäß PCI 2.2)</li> <li>• einen freien PCIe-Steckplatz x1 oder x4, 1.0a kompatibel für PCIe-Bus Karten Andere Steckplätze, z. B. x4, x8, x16 können genutzt werden, wenn sie vom BIOS und vom Betriebssystem unterstützt werden.</li> </ul> <p><b>Hinweis:</b> Der PCIe-Steckplatz x4 wird nur für die Installation der Dialogic® Diva® V-4PRI PCIe FS und V-8PRI PCIe FS Karten benötigt.</p> <ul style="list-style-type: none"> <li>• ein installiertes Betriebssystem: Linux, Microsoft® Windows® 7 Microsoft® Windows Server® 2008, Microsoft® Windows Vista®, Microsoft® Windows Server® 2003, Microsoft® Windows® XP</li> <li>• mindestens 15 MB freien Speicherplatz auf der Festplatte für die Dialogic® Diva® System Release Software</li> </ul>
Lieferumfang der Dialogic® Diva® ISDN-Karten	<p>Der Lieferumfang Ihrer Diva ISDN-Karte enthält folgende Komponenten:</p> <ul style="list-style-type: none"> <li>• Diva ISDN-Karte</li> <li>• ein oder mehrere benötigte ISDN RJ-45 Verbindungskabel (nur für Dialogic® Diva® BRI)</li> <li>• Dialogic® Diva® V-8PRI PCIe FS Media Board: vier Kabel mit Dual-Adapter</li> <li>• Dialogic® Diva® Karten Installationsanleitung</li> </ul>
Lieferumfang der Dialogic® Diva® Analogkarte	<p>Der Lieferumfang Ihrer Diva Analogkarte enthält folgende Komponenten:</p> <ul style="list-style-type: none"> <li>• Diva Analogkarte</li> <li>• Verbindungskabel zum Anschluss an die Analogleitung</li> <li>• Alle Dialogic® Diva® Analog-8: vier Kabel mit Dual-Adapter</li> <li>• Diva Karten Installationsanleitung</li> </ul>
Kabel	<p>Bei Dialogic® Diva® PRI Karten gehören die RJ-45 Kabel nicht zum Lieferumfang, sie müssen von einem Händler bezogen werden.</p>
CSU/DSU	<p>Dialogic® Diva® V-1PRI PCIe HS, V-2PRI PCIe HS, V-4PRI PCIe HS, V-4PRI PCIe FS und V-8PRI PCIe FS haben keine eingebaute CSU/DSU (Channel Service Unit/Data Service Unit). Diese muss von einem Händler bezogen und extern angeschlossen werden. Sehen Sie dazu <a href="#">Anschließen einer Dialogic® Diva® PRI</a> auf Seite 95.</p>

Komponente	Beschreibung
ISDN-Basis- (S <sub>0</sub> ), Primärmultiplexanschluss (S <sub>2M</sub> ) oder Analoganschluss	Die Anschlüsse werden von der zuständigen Telefongesellschaft eingerichtet. Achten Sie darauf, dass Sie den/die zu Ihrer Dialogic® Diva® Karte passenden Anschluss/Anschlüsse erhalten.
Informationen zum Anschluss	Ihre Telefongesellschaft muss die folgenden Informationen bereitstellen: <ul style="list-style-type: none"> <li>• ISDN- oder analoge Rufnummern für jede Leitung</li> <li>• ISDN-Übertragungsprotokoll (D-Kanal-Protokoll): Das Protokoll ist normalerweise abhängig von der Region. Beispiele für gebräuchliche Übertragungsprotokolle sind: Euro-ISDN DSS1 (wird in Europa verwendet und auch als ETSI-Standard bezeichnet), 1TR6 (wird hauptsächlich in digitalen Nebenstellenanlagen in Deutschland verwendet).</li> </ul>

## Installation

Dieser Abschnitt beschreibt die Installation Ihrer Dialogic® Diva® Karte und das Anschließen an die Leitung.

Führen Sie die folgenden Schritte durch, um Ihre Diva Karte erfolgreich einzusetzen:

- (A) Die Diva Karte in Ihren Computer einstecken, wie unten beschrieben.
- (B) Die Diva Karte anschließen, wie auf Seite 93 beschrieben.
- (C) Die Dialogic® Diva® System Release Software installieren, wie auf Seite 105 beschrieben.

**Hinweis:** Halten Sie Ihr Computerhandbuch während der Installation der Karte bereit.

### (A) Die Dialogic® Diva® Karte in Ihren Computer einstecken

1. Schalten Sie den Computer und alle Peripheriegeräte aus und ziehen Sie von allen Geräten den Stecker, um Verletzungen zu vermeiden.
2. Entladen Sie die statische Aufladung Ihres Körpers, indem Sie das Metallgehäuse berühren (die nicht-lackierte Rückseite des Computer-Gehäuses).
3. Ziehen Sie das ISDN-Kabel, wenn vorhanden, und das Netzkabel vom Computer ab.
4. Nehmen Sie die Abdeckung des Computers ab (siehe Computer-Handbuch).
5. Suchen Sie in Ihrem Computer einen freien PCI- oder PCIe-Steckplatz.
6. Lösen Sie die Schraube oder lockern Sie den Clip. Achten Sie darauf, die Schraube nicht zu verlieren. Entfernen Sie ggf. die hintere Metallschiene des Steckplatzes.

7. Wenn Ihre Dialogic® Diva® Karte einen Haltebügel hat und dieser bei der Installation stört, können Sie ihn auch abmontieren. Er ist lediglich eine Installationshilfe und trägt nicht zum Funktionieren der Diva Karte bei.

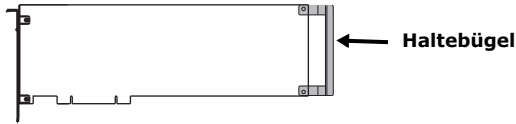

8. Bevor Sie die Diva Karte in den Steckplatz einsetzen, lesen Sie folgenden Sicherheitshinweis:

**VORSICHT:**



Damit keine Hardwareschäden auftreten, dürfen Sie die Diva Karte, je nach Typ, nur in einen PCI- oder PCIe-Steckplatz einsetzen. Wenn Sie eine Diva Karte in einen Steckplatz anderen Typs einsetzen, können die Karte, der Computer oder beide beschädigt werden.

9. Setzen Sie die Diva Karte in den Steckplatz ein. Stellen Sie sicher, dass die Diva Karte weder die CPU, noch die Speichermodule oder andere Bauteile auf der Hauptplatine berührt.

**Hinweis:** Die Dialogic® Diva® V-2PRI PCI und V-4PRI PCI haben zusätzlich zum PCI-Bus einen H.100-Bus auf der Karte, der nicht betriebsbereit ist. Setzen Sie Ihre Diva Karte nur mit dem PCI-Bus in einen PCI-Steckplatz ein.

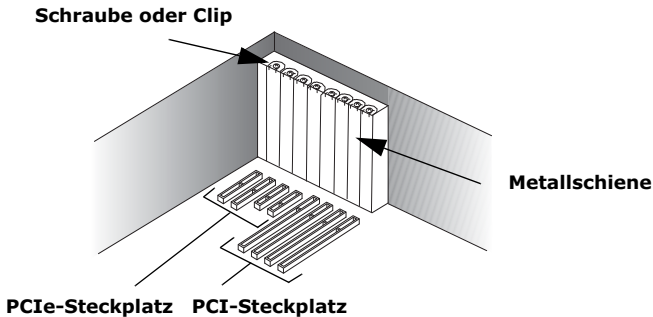

- 10.** Befestigen Sie die Diva Karte mit der Schraube oder dem Clip, damit sie fest mit dem Gehäuse des Computers verbunden ist.

**VORSICHT:** Achten Sie darauf, die Metallschiene der Diva Karte zu verschrauben, so dass sie fest mit dem Computergehäuse verbunden ist. Dadurch wird die richtige Erdung sichergestellt und somit Verletzungen und Schäden am Computer und an der Diva Karte vermieden.



- 11.** Bringen Sie die Abdeckung des Computers wieder an (siehe Computer-Handbuch).

### **(B) Die Dialogic® Diva® Karte anschließen**

Das Anschließen der Diva Karte ist abhängig vom Kartentyp:

- Wenn Sie eine Dialogic® Diva® BRI anschließen, folgen Sie den Anweisungen auf Seite 93.
- Wenn Sie eine Dialogic® Diva® PRI anschließen, folgen Sie den Anweisungen auf Seite 95.
- Wenn Sie eine Dialogic® Diva® Analog anschließen, folgen Sie den Anweisungen auf Seite 101.

### **Anschließen einer Dialogic® Diva® BRI**

**Hinweis:** Wenn Sie Ihre Diva BRI als Master für TK-Anlagen oder als Netzabschluss für den Back-to-Back Betrieb einsetzen möchten, sehen Sie Seite 94.

*In Europa und den meisten Ländern weltweit:*

In Europa und den meisten anderen Ländern außer Nordamerika und Japan kann die ISDN-Karte mit dem mitgelieferten Kabel direkt an die ISDN-Leitung angeschlossen werden.

- 1. Nehmen Sie das mitgelieferte ISDN-Kabel und stecken Sie ein Ende in die Diva Karte.**

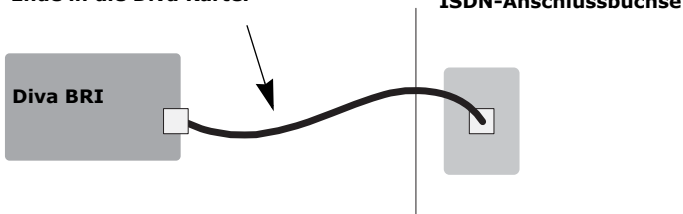

- 2. Stecken Sie das andere Ende des Kabels in die ISDN-Anschlussbuchse.**

**Hinweis für alle Dialogic® Diva® 4BRI:**

Die Diva 4BRI haben vier Ports zum Anschließen an vier separate ISDN-Basisanschlüsse. Schließen Sie die vier mitgelieferten Kabel an, wie in der Abbildung oben beschrieben. Sie können beliebige Ports verwenden, müssen in der Regel aber die Port-Nummer während der Software-Konfiguration angeben. Sehen Sie auf der nächsten Seite die Port-Nummern. In der Abbildung weist der Kartensteckverbinder nach unten.

***Dialogic® Diva® BRI als Netzabschluss anschließen:***

Die Dialogic® Diva® System Release Software bietet die Möglichkeit, die Diva BRI als Netzabschluss (NT) zu betreiben. Der NT-Modus ermöglicht den Einsatz von Diva Karten als Master bei der Kopplung von TK-Anlagen, z. B. Kopplung von TK-Anlagen mit Q-Sig. Außerdem ermöglicht er, zwei Diva Karten im Back-to-Back Betrieb einzusetzen.

Wenn Sie die Dialogic® Diva® Karte an eine TK-Anlage anschließen, die als Endgerät (TE) agiert und daher einen Netzabschluss erfordert, der die Taktung generiert, konfigurieren Sie die Diva Karte als Netzabschluss. Schließen Sie die Diva Karte an die TK-Anlage an, wie im Diagramm unten dargestellt. Nehmen Sie hierzu die entsprechende Anschlussbelegung an der TK-Anlage vor. Verwenden Sie die erforderlichen Abschlusswiderstände.

Wenn Sie zwei Diva Karten im Back-to-Back Betrieb einsetzen, konfigurieren Sie eine Karte als NT und die andere als TE. Verbinden Sie die Karten mit einem gekreuzten Kabel. Die Kabelbelegung und die erforderlichen Abschlusswiderstände können Sie dem Diagramm auf der nächsten Seite entnehmen.

Pol- (Kontakt-) Belegung für 8-polige Verbindungen (Stecker und Buchsen):

Pins auf RJ-45	TE		Verdrahtung	NT	
	Draht	Signal		Draht	Signal
1	nicht verwendet				
2	nicht verwendet				
3	2a	TX +		1a	TX +
4	1a	RX +		2a	RX +
5	1b	RX -		2b	RX -
6	2b	TX -		1b	TX -
7	nicht verwendet				
8	nicht verwendet				

Abschlusswiderstände  
100 Ohm, 5%

**Hinweis:** Pin 1 befindet sich links (siehe Abbildung unten), wenn Sie den RJ-45 Stecker mit dem Kabel nach unten, den Pins zu Ihnen und der Lasche von Ihnen weg gerichtet betrachten.

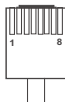

## Anschließen einer Dialogic® Diva® PRI

**Hinweis:** Dialogic® Diva® PRI, außer Dialogic® Diva® V-xPRI PCIe HS/FS, haben eine eingebaute CSU (Channel Service Unit), die sie vor Beschädigungen durch Stromstöße schützt. Sie können jedoch auch eine zusätzliche externe CSU benutzen, die Ihnen die Überprüfung Ihrer ISDN-Leitung ermöglicht.

Verwenden Sie ein RJ-45 Kabel, um Ihre Diva PRI anzuschließen. Wie Sie das Kabel benutzen, hängt davon ab, wie Sie Ihre Diva PRI einsetzen:

- RJ-45 zu RJ-45: zum Anschluss an eine ISDN-Leitung mit RJ-45 Buchse und zum Einsatz als Master für eine TK-Anlage.
- RJ-45 zum offenen Kabelende: zur selbstdefinierten Leitungsbelegung entsprechend dem verwendeten NT und zum Einsatz im Back-to-Back Betrieb.

Wenn die ISDN-Leitung mit einer RJ-45 Buchse installiert ist:

Verwenden Sie das Kabel mit RJ-45 Steckern auf beiden Seiten:

Diva PRI	Signal	RJ-45 Stecker
Pin 1	Receive + (RX +)	Pin 1
Pin 2	Receive - (RX -)	Pin 2
Pin 4	Transmit + (TX +)	Pin 4
Pin 5	Transmit - (TX -)	Pin 5
abgeschirmter Stecker	völlig abgeschirmt	abgeschirmter Stecker

**Hinweis:** Verwenden Sie für den E1 Modus mit 75 Ohm Impedanz einen externen 75 Ohm Balun-Adapter. Sie können einen solchen Adapter in Fachgeschäften erwerben.

Das Anschließen Ihrer Dialogic® Diva® PRI Karte hängt vom Kartentyp ab:

- Für alle Diva PRI Karten, außer Dialogic® Diva® V-8PRI PCIe FS Media Boards, folgen Sie den nachfolgenden Anweisungen.
- Für Dialogic® Diva® V-8PRI PCIe FS Media Boards, folgen Sie den Anweisungen auf Seite 98.

**Schließen Sie Ihre Dialogic® Diva® PRI Karte (außer Diva V-8PRI PCIe FS) wie hier dargestellt an das ISDN an:**

1. Nehmen Sie ein ISDN-Kabel und stecken Sie ein Ende des Kabels in die Diva Karte.

ISDN-Anschlussbuchse, NT bzw. CSU

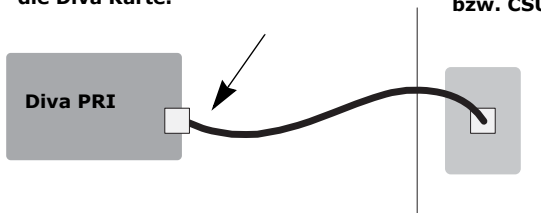

2. Stecken Sie das andere Ende des Kabels in die ISDN-Anschlussbuchse oder die CSU.

**Hinweis für alle Dialogic® Diva® V-2PRI und V-4PRI:**

Die Diva V-2PRI hat zwei Ports und die Diva V-4PRI hat vier Ports zum Anschließen an vier separate ISDN-Primärmultiplexanschlüsse. Schließen Sie vier RJ-45 Kabel an, wie in der Abbildung oben beschrieben. Sie können beliebige Ports verwenden, müssen in der Regel aber die Port-Nummer während der Softwarekonfiguration angeben. Sehen Sie auf der nächsten Seite die Portnummern. In der Abbildung weist der Kartensteckverbinder nach unten.



Diva V-2PRI

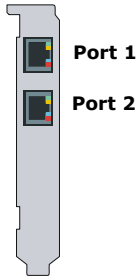

Diva V-4PRI

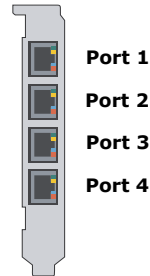

**Hinweis für Dialogic® Diva® V-1PRI PCIe HS, Diva V-2PRI PCIe HS, Diva V-4PRI PCIe HS und Diva V-4PRI PCIe FS:**

Die Diva V-xPRI PCIe HS und V-4PRI PCIe FS haben vier Ports. Das "x" bzw. die "4" im Namen steht für die aktivierten Ports, d. h. 1 Port ist auf der Diva V-1PRI HS aktiviert, 2 auf der Diva V-2PRI HS und 4 auf der Diva V-4PRI HS und Diva V-4PRI FS. Sie können nur die aktivierten Ports benutzen (siehe Abbildung unten). In der Abbildung weist der Kartensteckverbinder nach unten. In der Regel müssen Sie die Port-Nummer während der Softwarekonfiguration angeben.

Diva V-1PRI HS

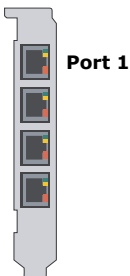

Diva V-2PRI HS

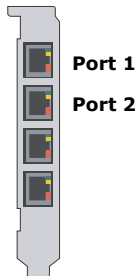

Diva V-4PRI HS



Diva V-4PRI FS

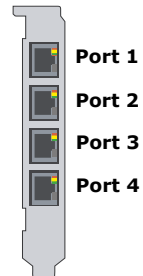

**Hinweis:** Die Diva V-1PRI PCIe HS, V-2PRI PCIe HS, V-4PRI PCIe HS und V-4PRI PCIe FS haben keine eingebaute CSU/DSU (Channel Service Unit/Data Service Unit). Diese muss von einem Händler bezogen und extern angeschlossen werden.

### Dialogic® Diva® V-8PRI PCIe FS

Die Diva V-8PRI PCIe FS hat vier RJ-45 Ports zum Anschließen an vier RJ-45 Adapter, die je zwei RJ-45 Buchsen haben. Somit repräsentiert jeder Port auf der Diva Karte zwei Ports an der ISDN-Anschlussbuchse, NT oder CSU. Sie können beliebige Ports verwenden, müssen in der Regel aber die Port-Nummer während der Softwarekonfiguration angeben. Sehen Sie unten die Port-Nummern. In der Abbildung weist der Kartensteckverbinder nach unten.



**Hinweis:** Die Diva V-8PRI PCIe FS hat keine eingebaute CSU/DSU (Channel Service Unit/Data Service Unit). Diese muss von einem Händler bezogen und extern angeschlossen werden.

### Schließen Sie Ihre Diva V-8PRI PCIe FS wie hier dargestellt an das ISDN an:

**1. Nehmen Sie die vier mitgelieferten Kabel mit Dual-Adapter und stecken Sie die RJ-45 Stecker in die Diva V-8PRI PCIe FS.**

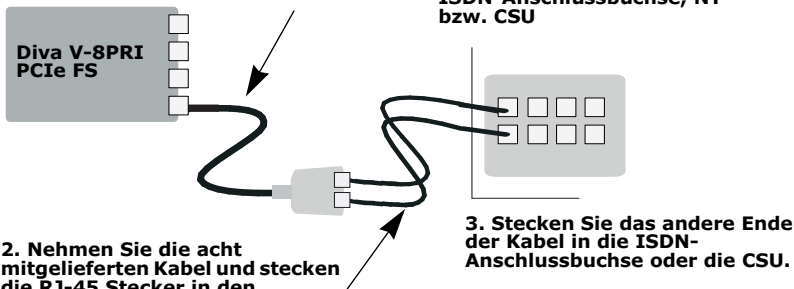

**2. Nehmen Sie die acht mitgelieferten Kabel und stecken die RJ-45 Stecker in den Dual-Adapter. Wobei Buchse „A“ den Ports 1, 2, 3 und 4 entspricht und Buchse „B“ den Ports 5, 6, 7 und 8.**

**3. Stecken Sie das andere Ende der Kabel in die ISDN-Anschlussbuchse oder die CSU.**

Verwenden Sie das Kabel mit Dual-Adapter:

RJ45	Signal	Dual-Adapter mit RJ45 Buchsen	Signal	
Pin 1	Receive + (RX +) (Port A)	Port A	Pin 1	Receive + (RX +)
Pin 2	Receive - (RX -) (Port A)		Pin 2	Receive - (RX -)
Pin 3	Receive + (RX +) (Port B)		Pin 4	Transmit + (TX +)
Pin 4	Transmit + (TX +) (Port A)		Pin 5	Transmit - (TX -)
Pin 5	Transmit - (TX -) (Port A)	Port B	Pin 1	Receive + (RX +)
Pin 6	Receive - (RX -) (Port B)		Pin 2	Receive - (RX -)
Pin 7	Transmit + (TX +) (Port B)		Pin 4	Transmit + (TX +)
Pin 8	Transmit - (TX -) (Port B)		Pin 5	Transmit - (TX -)

**Hinweis:** Pin 1 befindet sich links (siehe Abbildung unten), wenn Sie den RJ-45 Stecker mit dem Kabel nach unten, den Pins zu Ihnen und der Lasche von Ihnen weg gerichtet betrachten.



*Wenn die Dialogic® Diva® Karte als NT an eine TK-Anlage angeschlossen wird:*

Die Dialogic® Diva® System Release Software bietet die Möglichkeit, Diva Karten als Netzabschluss (NT) einzusetzen. Dies ermöglicht den Einsatz von Diva PRI als Master bei der Kopplung von TK-Anlagen z. B. mit dem Q-Sig Protokoll.

Konfigurieren Sie die Diva Karte als Netzabschluss, wenn Sie die Diva Karte an eine TK-Anlage anschließen, die als Endgerät (TE) agiert und daher einen Netzabschluss zum Generieren der Taktung erfordert. Schließen Sie die Diva Karte an die TK-Anlage an, wie im Diagramm auf Seite 100 dargestellt. Nehmen Sie hierzu die entsprechende Anschlussbelegung an der TK-Anlage vor.

*Wenn der NT offene Drahtanschlüsse benutzt:*

In einigen Fällen müssen Sie Ihre Diva Karte an einen NT mit offenen Verbindungen anschließen. Die Sende- (TX) und Empfangsleitungen (RX) sind durch die Farbe der Leitungen gekennzeichnet; Sendeleitungen sind blau und weiß-blau, Empfangsleitungen sind orange und weiß-orange.

Verwenden Sie das ISDN-Kabel mit offenen Kabelenden:

Diva PRI	Signal	Offene Enden
Pin 1	Receive + (RX +)	weiß-orange
Pin 2	Receive - (RX -)	orange
Pin 4	Transmit + (TX +)	blau
Pin 5	Transmit - (TX -)	weiß-blau
abgeschirmter Stecker	völlig abgeschirmt	Abschirmung

Stellen Sie sicher, dass die Sendeleitungen Ihrer Diva PRI an die Empfangsanschlüsse des NTs und die Empfangsleitungen Ihrer Diva PRI an die Sendeanschlüsse des NTs angeschlossen werden.

**Hinweis:** Wenn Ihre Diva PRI nicht richtig am ISDN angeschlossen ist, leuchtet sowohl am NT als auch in der Vermittlungsstelle der zuständigen Telefongesellschaft eine Schicht 1 Warnlampe auf. Wenn Sie eine externe CSU verwenden, leuchtet auch eine Warnlampe an der CSU auf. Die Leitung wird daraufhin möglicherweise von der Telefongesellschaft deaktiviert und muss manuell wieder von der Telefongesellschaft aktiviert werden. Zu diesem Zweck sollten Sie die Störungsstelle der zuständigen Telefongesellschaft informieren.

*Wenn die Dialogic® Diva® PRI im Back-to-Back Betrieb eingesetzt wird:*

Die Dialogic® Diva® System Release Software bietet die Möglichkeit, Dialogic® Diva® Karten als Netzabschluss (NT) einzusetzen. Dies ermöglicht Ihnen, zwei Diva Karten im Back-to-Back Betrieb zu verwenden. Hierzu konfigurieren Sie eine Diva Karte als Netzabschluss (NT) und die andere als Endgerät (TE). Verbinden Sie die Diva Karten mit einem gekreuzten Kabel. Sie können ein solches Kabel herstellen, indem Sie ein RJ-45-Kabel mit offenen Kabelenden benutzen und das offene Ende entsprechend der Pin-Belegung für den NT-Modus terminieren, wie in der folgenden Tabelle dargestellt:

	TE	Verdrahtung	NT	
Pins auf dem RJ-45	Signal		Signal	
1	RX +		RX +	
2	RX -		RX -	
3	nicht verwendet			
4	TX +		TX +	
5	TX -		TX -	
6	nicht verwendet			
7	nicht verwendet			
8	nicht verwendet			

**Hinweis:** Pin 1 befindet sich links (siehe Abbildung unten), wenn Sie den RJ-45 Stecker mit dem Kabel nach unten, den Pins zu Ihnen und der Lasche von Ihnen weg gerichtet betrachten.

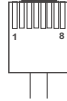

## Anschließen einer Dialogic® Diva® Analog

Verwenden Sie die mitgelieferten Kabel, um Ihre Diva Analog anzuschließen. Das Anschließen der Diva Analog hängt vom Kartentyp ab:

- Wenn Sie eine Dialogic® Diva® Analog-2 anschließen, folgen Sie den nachfolgenden Anweisungen.
- Wenn Sie eine Dialogic® Diva® Analog-4 anschließen, folgen Sie den Anweisungen auf Seite 102.
- Wenn Sie eine Dialogic® Diva® Analog-8 anschließen, folgen Sie den Anweisungen auf Seite 104.

**Wichtig:** Benutzen Sie nur Kabel mit mindestens Nr. 26 AWG (American Wire Gauge).

### Dialogic® Diva® Analog-2:

Die Diva Analog-2 hat zwei RJ-10 Ports zum Anschließen an zwei separate Analoganschlüsse. Sie können beliebige Ports verwenden, müssen in der Regel aber die Port-Nummer während der Softwarekonfiguration angeben. Sehen Sie unten die Port-Nummern. In der Abbildung weist der Kartensteckverbinder nach unten.

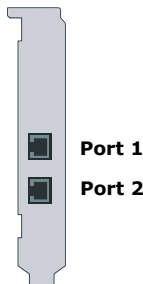

Schließen Sie die Diva Analog-2 wie folgt an:

- 1. Nehmen Sie die zwei mitgelieferten Kabel und stecken Sie die RJ-10 Stecker in die Ports der Diva Analogkarte.**

**TAE-Anschlussbuchsen oder Telefonanlage**

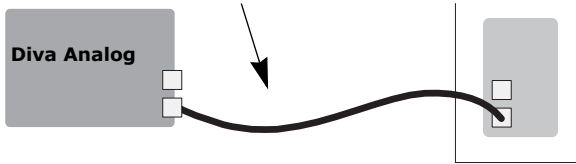

- 2. Stecken Sie die RJ-11 Stecker in die TAE-Buchsen oder in die Telefonanlage.**

Kontaktbelegung (Stecker und Buchsen):

RJ-10	Signal	RJ-11
Pin 2	Ring	Pin 3
Pin 3	Tip	Pin 4

**Hinweis:** Pin 1 befindet sich links (siehe Abbildung unten), wenn Sie den RJ-10 oder RJ-11 Stecker mit dem Kabel nach unten, den Pins zu Ihnen und der Lasche von Ihnen weg gerichtet betrachten.

**RJ-10 Stecker**



**RJ-11 Stecker**

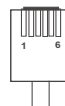

### **Dialogic® Diva® Analog-4:**

Die Diva Analog-4 hat vier RJ-10 Ports zum Anschließen an vier separate Analoganschlüsse. Sie können beliebige Ports verwenden, müssen in der Regel aber die Port-Nummer während der Softwarekonfiguration angeben. Sehen Sie auf der nächsten Seite die Port-Nummern. In der Abbildung weist der Kartensteckverbinder nach unten.

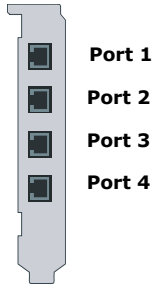

Schließen Sie die Dialogic® Diva® Analog-4 wie folgt an:

1. Nehmen Sie die vier mitgelieferten Kabel und stecken Sie die RJ-10 Stecker in die Ports der Diva Analogkarte.

TAE-Anschlussbuchsen  
oder Telefonanlage

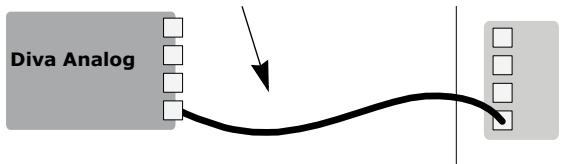

2. Stecken Sie die RJ-11 Stecker in die TAE-Buchsen oder in die Telefonanlage.

Kontaktbelegung (Stecker und Buchsen):

RJ-10	Signal	RJ-11
Pin 2	Ring	Pin 3
Pin 3	Tip	Pin 4

**Hinweis:** Pin 1 befindet sich links (siehe Abbildung unten), wenn Sie den RJ-10 oder RJ-11 Stecker mit dem Kabel nach unten, den Pins zu Ihnen und der Lasche von Ihnen weg gerichtet betrachten.

RJ-10 Stecker

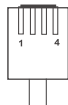

RJ-11 Stecker



### Dialogic® Diva® Analog-8:

Die Diva Analog-8 hat vier RJ-45 Ports zum Anschließen an vier RJ-45/RJ-10 Adapter, die je zwei RJ-10 Buchsen haben. Somit repräsentiert jeder Port auf der Diva Karte zwei Ports an der TAE-Anschlussbuchse oder Telefonanlage. Sie können beliebige Ports verwenden, müssen in der Regel aber die Port-Nummer während der Softwarekonfiguration angeben. Sehen Sie unten die Port-Nummern. In der Abbildung weist der Kartensteckverbinder nach unten.

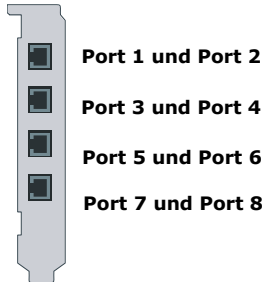

Schließen Sie Ihre Dialogic® Diva® Analog-8 wie folgt an:

**1. Nehmen Sie die vier mitgelieferten Kabel mit Dual-Adapter und stecken Sie die RJ-45 Stecker in die Diva Analogkarte.**

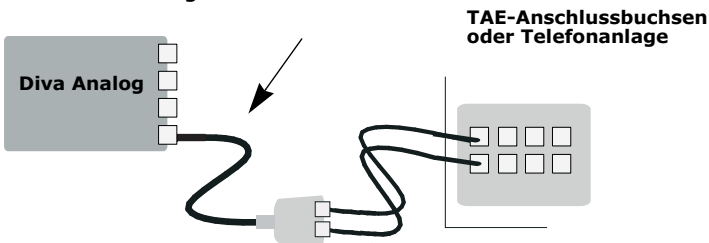

**2. Nehmen Sie die acht mitgelieferten Kabel und stecken die RJ-10 Stecker in den Dual-Adapter. Wobei Buchse „A“ den Ports 1,3,5 und 7 entspricht und Buchse „B“ den Ports 2,4,6 und 8.**

**3. Stecken Sie die RJ-11 Stecker in die TAE-Buchsen oder in die Telefonanlage.**



Kontaktbelegung (Stecker und Buchsen):

RJ-45	Signal	Dual-Adapter mit RJ-10 Buchsen		RJ-11
Pin 1	Ring	Buchse A	Pin 2	Pin 3
Pin 2	Tip		Pin 3	Pin 4
Pin 7	Tip	Buchse B	Pin 3	Pin 4
Pin 8	Ring		Pin 2	Pin 3

**Hinweis:** Pin 1 befindet sich links (siehe Abbildung unten), wenn Sie den RJ-45, RJ-10 oder RJ-11 Stecker mit dem Kabel nach unten, den Pins zu Ihnen und der Lasche von Ihnen weg gerichtet betrachten.

**RJ-45 Stecker**



**RJ-10 Stecker**



**RJ-11 Stecker**

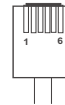

### (C) Die Dialogic® Diva® System Release Software installieren

Informationen zur Installation der Software für Ihre Dialogic® Diva® Karte finden Sie in der Online-Dokumentation, die mit den Softwaretreibern mitgeliefert wird oder auf der Dialogic Internetseite unter <http://www.dialogic.com/manuals/default.htm> verfügbar ist.

Betriebssystem	Dokumentation
Alle Windows® Betriebssysteme	Dialogic® Diva® System Release WIN Reference Guide (englisch)
Linux	Dialogic® Diva® System Release LIN Reference Guide (englisch)

## Problembehandlung

Die folgenden Hinweise helfen bei der Diagnose und beim Beheben von Fehlern, die mit der Dialogic® Diva® Karte oder der dazugehörigen Software auftreten können. Reichen diese Hinweise zur Fehlerbehebung nicht aus, finden Sie im Online Reference Guide (auf Englisch) oder in der Online-Hilfe (auf Englisch) zur jeweiligen Software und auf der Dialogic Services & Support Internetseite (siehe Seite 123) weitere Informationen.

### Dialogic® Diva® Line Test (Anschlussstest)

*(nur für Microsoft® Windows® Betriebssysteme)*

Mit dem Diva Line Test Tool können Sie Ihre Dialogic® Diva® Karte und Ihren Analog- oder ISDN-Anschluss überprüfen.

Zum Öffnen des Diva Line Test Tools klicken Sie auf **Start > Programme > Dialogic Diva > Line Test**.

Sie können folgende Tests durchführen:

- Line Check: Dieser Test überprüft, ob eine Verbindung zur Gegenstelle aufgebaut werden kann.
- Hardware Test: Dieser Test überprüft die Controller auf der Diva Karte.
- Telefon/Loop: Der Telefon-/Looptest führt einen Ruf zu einem anderen Telefon oder zum eigenen Anschluss durch.
- Call Transfer: Dieser Test führt Rufweiterleitungen durch. Dabei kann die Art der Rufweiterleitung ausgewählt werden.
- Fax: Mit diesem Test können Sie Testfaxe senden oder empfangen.

Für weitere Informationen sehen Sie die Dialogic® Diva® Line Test Online-Hilfe (DSLLineTest.chm).

## Status-LEDs

Dialogic® Diva® BRI und PRI Karten haben zwei oder vier Status-LEDs mit unterschiedlichen Funktionen.

### Dialogic® Diva® BRI und Diva UM-BRI

Die Diva BRI-CTI, Diva BRI-2FX, Diva BRI-2, Diva UM-BRI-2, Diva 4BRI-8 und Diva UM-4BRI-8 haben zwei LEDs pro Port:

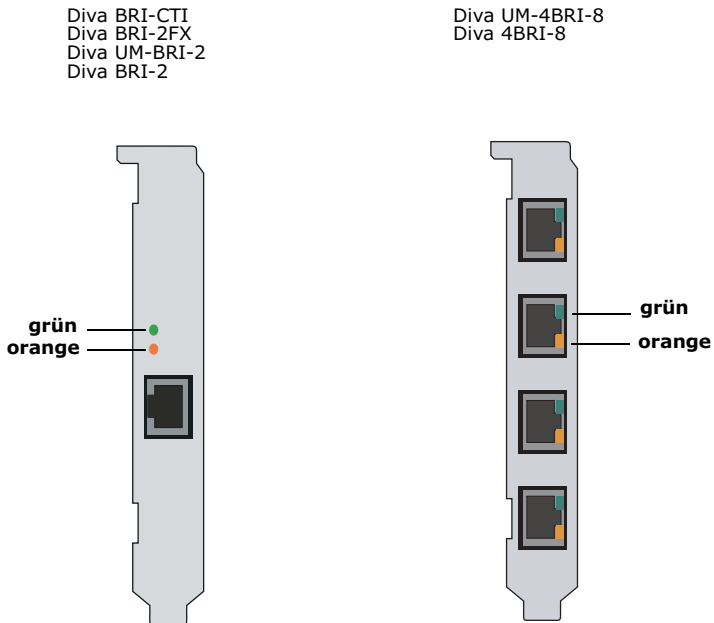

Die untenstehende Tabelle beschreibt die Funktion der LEDs:

Farbe	Status	Beschreibung
grün	aus	Schicht 1 ist nicht aktiv.
	an	Schicht 1 ist aktiv. Die Verkabelung und die Verbindung zum ISDN funktionieren fehlerfrei.
orange	aus	Schicht 2, der D-Kanal, ist nicht aktiv.
	an	Schicht 2, der D-Kanal, ist aktiv. In Europa ist der Status des D-Kanals von der Protokollkonfiguration abhängig. Die LED leuchtet entweder nur solange die Verbindung steht oder dauerhaft.

## Dialogic® Diva® PRI, Diva V-PRI und Diva UM-PRI

Alle Diva PRI haben vier LEDs:

Div a PRI 3.0  
 Div a V-PRI  
 Div a UM-PRI

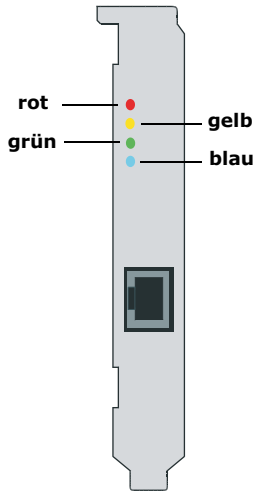

DEUTSCH

Die untenstehende Tabelle beschreibt die Funktion jeder LED:

Farbe	Status	Beschreibung
gelb	aus	Normaler Betrieb.
	an	Die entfernte Station hat Synchronisationsprobleme. (remote alarm / yellow alarm)
rot	aus	Normaler Betrieb.
	an	Der Empfänger nimmt kein Signal auf. (loss of signal / red alarm)
blau	aus	Normaler Betrieb.
	an	Die empfangenen Rahmen sind nicht korrekt synchronisiert. (alarm indication signal / blue alarm)
grün	aus	Schicht 2 ist nicht aktiv. Überprüfen Sie Ihre Schicht 2 Konfiguration, d. h. D-Kanal-Protokoll, Telefonanlage, etc.
	an	Schicht 2 ist aktiv. Wenn Ihre Dialogic® Diva® PRI korrekt funktioniert, ist die Schicht 2 permanent aktiv.

## Dialogic® Diva® V-2PRI and Diva V-4PRI

Diva V-xPRI PCI haben pro Port zwei Multifunktions-LEDs pro Port:

Diva V-2PRI

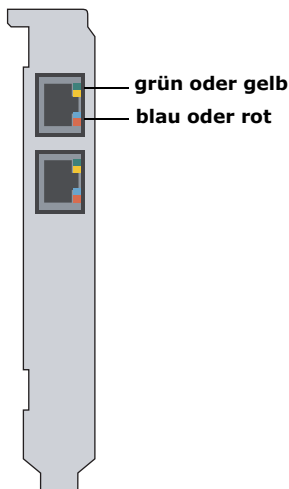

Diva V-4PRI

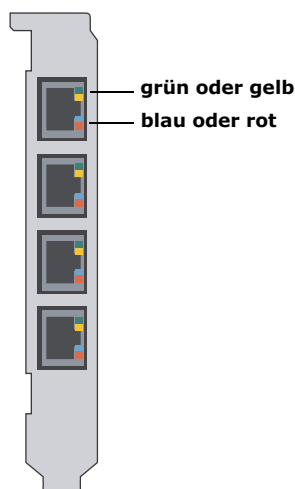

Die untenstehende Tabelle beschreibt die Funktion jeder LED:

Farbe	Status	Beschreibung
grün	aus	Schicht 2 ist nicht aktiv. Überprüfen Sie Ihre Schicht 2 Konfiguration, d. h. D-Kanal-Protokoll, Telefonanlage, etc.
	an	Schicht 2 ist aktiv. Wenn Ihre Dialogic® Diva® PRI korrekt funktioniert, ist die Schicht 2 permanent aktiv.
gelb	aus	Normaler Betrieb.
	an	Die entfernte Station hat Synchronisationsprobleme. (remote alarm / yellow alarm)
blau	aus	Normaler Betrieb.
	an	Die empfangenen Rahmen sind nicht korrekt synchronisiert. (alarm indication signal / blue alarm)
rot	aus	Normaler Betrieb.
	an	Der Empfänger nimmt kein Signal auf. (loss of signal / red alarm)

## Dialogic® Diva® V-1PRI PCIe HS, V-2PRI PCIe HS und V-4PRI PCIe HS

Diva V-xPRI PCIe haben Multifunktions-LEDs:

Diva V-1PRI PCIe HS  
 Diva V-2PRI PCIe HS  
 Diva V-4PRI PCIe HS

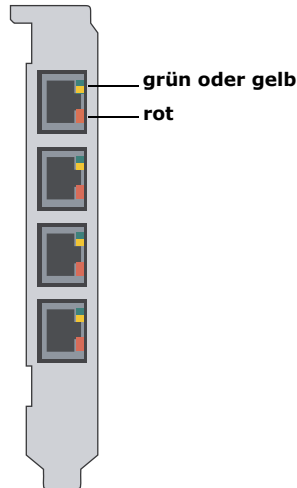

**Hinweis:** Auf der Diva V-1PRI HS und Diva V-2PRI HS Karte sind nicht alle Ports aktiviert. Weitere Informationen dazu finden Sie auf Seite 95.

Die untenstehende Tabelle beschreibt die Funktion jeder LED:

Farbe	Status	Beschreibung
grün	aus	Schicht 2 ist nicht aktiv. Überprüfen Sie Ihre Schicht 2 Konfiguration, d. h. D-Kanal-Protokoll, Telefonanlage, etc.
	an	Schicht 2 ist aktiv. Wenn Ihre Dialogic® Diva® PRI korrekt funktioniert, ist die Schicht 2 permanent aktiv.
gelb	aus	Normaler Betrieb.
	an	Die entfernte Station hat Synchronisationsprobleme. (remote alarm / yellow alarm)
rot	aus	Normaler Betrieb.
	an	Der Empfänger nimmt kein Signal auf. (loss of signal / red alarm)

## Dialogic® Diva® V-4PRI PCIe FS und V-8PRI PCIe HS

Diva V-xPRI PCIe FS haben Multifunktions-LEDs:

Diva V-4PRI PCIe FS

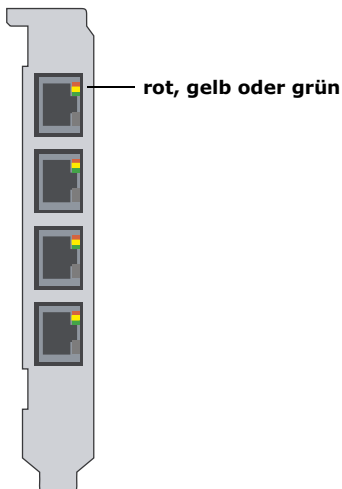

Diva V-8PRI PCIe FS

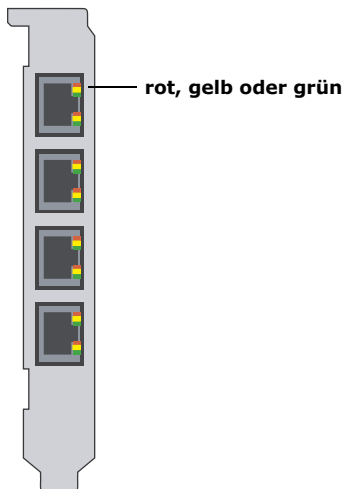

Die untenstehende Tabelle beschreibt die Funktion jeder LED:

Farbe	Status	Beschreibung
Alle Farben	aus	Software hat sich nicht initialisiert.
grün	an	Carries Sense (normale fehlerfreie Funktion)
gelb	an	Yellow alarm
	langsam blinken	Blue alarm
rot	an	Red alarm

## Technische Daten

### Umgebungsbedingungen:

- Betriebstemperatur: 10°C bis 50°C
- Maximal zulässige Spannungsschwankung: gemäß der entsprechenden PCI Spezifikation (PCI/PCIe)

	<b>Diva UM-BRI-2 Diva BRI-2</b>	<b>Diva UM-4BRI-8 Diva 4BRI-8</b>
Busformat	PCI (3,3/5,0 V)	
Prozessor	32 Bit RISC CPU, 100 MHz	
Speicher auf der Karte	8 MB SDRAM	16 MB SDRAM
IRQs (Interrupt Request Level)	Vom PC BIOS zugewiesen	
I/O-Basisadressen (hex)		
Gemeinsamer Speicher	8 MB	16 MB (Speicher)
DSPs	2 ADSP 2185	8 ADSP 2185
Abmessungen in mm (Länge x Höhe)		
Platine	167,65 x 64,41	174,63 x 106,68
Low Profile Metallschiene	181,36 x 80,06	
Metallschiene	180,96 x 120,88	187,84 x 126,37
Datenübertragungsrate		
B-Kanäle	2 x 64 kBit/s	4 x 2 x 64 kBit/s
D-Kanäle	1 x 16 kBit/s	4 x 16 kBit/s
Plug&Play	ja	
Stromsparmodus		
Anschlussbuchsen	1 x RJ-45 (ISDN S <sub>0</sub> )	4 x RJ-45 (ISDN S <sub>0</sub> )
Anschlussart	ISDN S <sub>0</sub> -Anschluss	4 parallele S <sub>0</sub> -Anschlüsse
Stromverbrauch	0,33 A @ +5 V typ.	0,58 A @ +5 V typ.



	<b>Diva UM-BRI-2 PCIe Diva BRI-2 PCIe</b>	<b>Diva UM-4BRI-8 PCIe Diva 4BRI-8 PCIe</b>
Busformat	PCIe 1.0a x1 Lane	
Prozessor	32 Bit RISC CPU, 100 MHz	
Speicher auf der Karte	64 MB SDRAM	
IRQs (Interrupt Request Level)	Vom PC BIOS zugewiesen	
I/O-Basisadressen (hex)		
Gemeinsamer Speicher	8 MB	16 MB (Speicher)
DSPs	2 ADSP 2185	8 ADSP 2185
Abmessungen in mm (Länge x Höhe)		
Platine	167,65 x 68,90	167,65 x 111,15
Low Profile Metallschiene	181,36 x 80,06	
Metallschiene	180,96 x 120,88	180,96 x 126,31
Datenübertragungsrate		
B-Kanäle	2 x 64 kBit/s	4 x 2 x 64 kBit/s
D-Kanäle	1 x 16 kBit/s	4 x 16 kBit/s
Plug&Play	ja	
Stromsparmmodus		
Anschlussbuchsen	1 x RJ-45 (ISDN S <sub>0</sub> )	4 x RJ-45 (ISDN S <sub>0</sub> )
Anschlussart	ISDN S <sub>0</sub> -Anschluss	4 parallele S <sub>0</sub> -Anschlüsse
Stromverbrauch	0,27 A @ 3,3 V typ. 0,17 A @ 12 V typ.	0,42 A @ 3,3 V typ. 0,19 A @ 12 V typ.

	<b>Diva BRI-CTI Diva BRI-2FXI</b>
Busformat	PCI (3,3/5,0 V)
Prozessor	32 Bit RISC CPU, 133 MHz
Speicher auf der Karte	8 MB SDRAM
IRQs (Interrupt Request Level)	Vom PC BIOS zugewiesen
I/O-Basisadressen (hex)	
Gemeinsamer Speicher	8 MB
DSPs	nein
Abmessungen in mm (Länge x Höhe)	
Platine	167,65 x 64,41
Low Profile Metallschiene	181,36 x 80,06
Metallschiene	180,96 x 120,88
Datenübertragungsrate	
B-Kanäle	2 x 64 kBit/s
D-Kanal	1 x 16 kBit/s
Plug&Play	ja
Stromsparmmodus	
Anschlussbuchse	1 x RJ-45 (ISDN S <sub>0</sub> )
Anschlussart	ISDN S <sub>0</sub> -Anschluss
Stromverbrauch	0,3 A @ +5 V typ.

	<b>Diva V-PRI Diva UM-PRI Diva PRI 3.0</b>
Busformat	PCI (3,3/5,0 V)
Prozessor	32 Bit RISC CPU, 300 MHz
Speicher auf der Karte	64 MB SDRAM
IRQs (Interrupt Request Level)	Vom PC BIOS zugewiesen
I/O-Basisadressen (hex)	
Gemeinsamer Speicher	8 MB
DSPs	2, 10 oder 31 ADSP 2185 je nach Modell
Abmessungen in mm (Länge x Höhe)	PRI/E1/T1-CTI, PRI/E1/T1-8:
Platine	174,63 x 106,68
Metallschiene	187,84 x 126,37
Abmessungen in mm	PRI/E1-30, V-PRI:
Platine	312,00 x 106,68
Metallschiene ohne Haltebügel	325,31 x 126,37
Metallschiene und Haltebügel	352,17 x 126,37
Datenübertragungsrate	
B-Kanäle	23 oder 30 x 64 kBit/s
D-Kanal	1 x 64 kBit/s
Plug&Play	ja
Stromsparmmodus	
Anschlussbuchse	1 x RJ-45 (ISDN S <sub>2M</sub> )
Anschlussart	ISDN S <sub>2M</sub> -Anschluss
Stromverbrauch	PRI/E1/T1-CTI: 0,58 A @ +5 V typ. 1,70 A @ +5 V max. PRI/E1/T1-8: 0,65 A @ +5 V typ. 2,00 A @ +5 V max. PRI/E1-30, V-PRI: 0,97 A @ +5 V typ. 2,70 A @ +5 V max.

	<b>Diva V-PRI PCIE</b> <b>Diva UM-PRI PCIE</b> <b>Diva PRI PCIE</b>
Busformat	PCIE 1.0a x1 Lane
Prozessor	32 Bit RISC CPU, 300 MHz
Speicher auf der Karte	64 MB SDRAM
IRQs (Interrupt Request Level)	Vom PC BIOS zugewiesen
I/O-Basisadressen (hex)	
Gemeinsamer Speicher	8 MB
DSPs	8 oder 31 ADSP 2185
Abmessungen in mm (Länge x Höhe)	PRI/E1/T1-CTI PCIE
Platine	167,65 x 68,90
Low Profile Metallschiene	181,38 x 80,06
Metallschiene	180,96 x 120,88
Abmessungen in mm	PRI/E1-30 PCIE, V-PRI PCIE:
Platine	312,00 x 111,15
Metallschiene ohne Haltebügel	325,31 x 126,31
Metallschiene und Haltebügel	352,17 x 126,31
Datenübertragungsrate	
B-Kanäle	30 x 64 kBit/s
D-Kanal	1 x 64 kBit/s
Plug&Play	
Stromsparmmodus	ja
Anschlussbuchse	1 x RJ-45 (ISDN S <sub>2M</sub> )
Anschlussart	ISDN S <sub>2M</sub> -Anschluss
Stromverbrauch	PRI/E1/T1 PCIE: 0,96 A @ +3,3 V typ. 0,04 A @ +12 V typ. PRI/E1-30 PCIE, V-PRI PCIE: 2,3 A @ +3,3 V typ. 0,03 A @ +12 V typ.

	<b>Divu V-2PRI PCI</b>	<b>Divu V-4PRI PCI</b>
Busformat	PCI (3,3/5,0 V)	
Prozessor	64 Bit RISC CPU, 466 MHz	
Speicher auf der Karte	64 MB SDRAM	
IRQs (Interrupt Request Level)	Vom PC BIOS zugewiesen	
I/O-Basisadressen (hex)		
Gemeinsamer Speicher	8 MB	
DSPs	10 ADSP-BF533 (32 MB SDRAM)	20 ADSP-BF533 (32MB SDRAM)
Abmessungen in mm (Länge x Höhe)		
Platine	312,00 x 106,68	
Metallschiene ohne Haltebügel	325,31 x 126,37	
Metallschiene und Haltebügel	352,17 x 126,37	
Datenübertragungsrate		
B-Kanäle	2 x 23 x 64 kBit/s oder 2 x 30 x 64 kBit/s	4 x 23 x 64 kBit/s oder 4 x 30 x 64 kBit/s
D-Kanäle	2 x 64 kBit/s	4 x 64 kBit/s
Plug&Play	ja	
Stromsparmodus		
Anschlussbuchsen	2 x RJ-45 (ISDN S <sub>2M</sub> )	4 x RJ-45 (ISDN S <sub>2M</sub> )
Anschlussart	2 parallele ISDN S <sub>2M</sub> -Anschlüsse	4 parallele ISDN S <sub>2M</sub> -Anschlüsse
Stromverbrauch	3,0 A @ +3,3 V typ. 4,9 A @ +3,3 V max. 0,02 A @ +5 V typ. 0,04 A @ +5 V max.	5,5 A @ +3,3 V typ. 6,5 A @ +3,3 V max. 0,04 A @ +5 V typ. 0,08 A @ +5 V max.

	<b>Divia V-1PRI PCIe HS</b>	<b>Divia V-2PRI PCIe HS</b>	<b>Divia V-4PRI PCIe HS</b>
Busformat	PCIe 1.0a x1 Lane		
Prozessor	64 Bit RISC CPU, 466 MHz		
Speicher auf der Karte	64 MB SDRAM		
IRQs (Interrupt Request Level)	Vom PC BIOS zugewiesen		
I/O-Basisadressen (hex)			
Gemeinsamer Speicher	8 MB		
DSPs	12 ADSP-BF533 (32 MB SDRAM)		
Abmessungen in mm (Länge x Höhe)			
Platine	167,65 x 111,15		
Metallschiene und Haltebügel	180,96 x 126,31		
Datenübertragungsr ate			
B-Kanäle	1 x 23 x 64 kBit/s oder 1 x 30 x 64 kBit/s	2 x 23 x 64 kBit/s oder 2 x 30 x 64 kBit/s	4 x 23 x 64 kBit/s oder 4 x 30 x 64 kBit/s
D-Kanäle	1 x 64 kBit/s	2 x 64 kBit/s	4 x 64 kBit/s
Plug&Play	ja		
Stromsparmmodus			
Anschlussbuchsen	1 x RJ-45 (ISDN S <sub>2M</sub> )	2 x RJ-45 (ISDN S <sub>2M</sub> )	4 x RJ-45 (ISDN S <sub>2M</sub> )
Anschlussart	1 paralleler ISDN S <sub>2M</sub> -Anschluss	2 paralleler ISDN S <sub>2M</sub> -Anschluss	4 parallele ISDN S <sub>2M</sub> -Anschlüsse
Stromverbrauch	0,91 A @ 3,3 V max. 1,0 A @ 12 V max.		

	<b>Diva V-4PRI PCIe FS</b>	<b>Diva V-8PRI PCIe FS</b>
Busformat	PCIe 1.0a x4 Lane	
Prozessor	64 Bit RISC CPU, 466 MHz	
Speicher auf der Karte	128 MB DDR2-SDRAM	
IRQs (Interrupt Request Level)	Vom PC BIOS zugewiesen	
I/O-Basisadressen (hex)		
Gemeinsamer Speicher	8 MB	
DSPs	24 ADSP-BF533 (32 MB SDRAM)	
Abmessungen in mm (Länge x Höhe)		
Platine	312,00 x 111,15	
Metallschiene ohne Haltebügel	325,31 x 126,31	
Metallschiene und Haltebügel	352,17 x 126,31	
Datenübertragungsr ate		
B-Kanäle	4 x 23 x 64 kBit/s oder 4 x 30 x 64 kBit/s	8 x 23 x 64 kBit/s oder 8 x 30 x 64 kBit/s
D-Kanäle	4 x 64 kBit/s	8 x 64 kBit/s
Plug&Play	ja	
Stromsparmmodus		
Anschlussbuchsen	4 x RJ-45 (ISDN S <sub>2M</sub> )	4 x RJ-45 (ISDN S <sub>2M</sub> )
Anschlussart	4 paralleler ISDN S <sub>2M</sub> -Anschluss	8 parallele ISDN S <sub>2M</sub> -Anschlüsse
Stromverbrauch	1,8 A @ 3,3 V typ. 1,5 A @ 12 V typ.	

	<b>Diva UM-Analog-2 Diva Analog-2</b>	<b>Diva V-Analog-4 Diva V-Analog-8 Diva UM-Analog-8 Diva Analog-4 Diva Analog-8</b>
Busformat	PCI (3,3/5,0 V)	
Prozessor	32 Bit RISC CPU, 100 MHz	
Speicher auf der Karte	16 MB SDRAM	
IRQs (Interrupt Request Level)	Vom PC BIOS zugewiesen	
I/O-Basisadressen (hex)		
Gemeinsamer Speicher	16 MB (Speicher)	
DSPs	2, 4 oder 8 ADSP 2185 je nach Kartentyp	
Abmessungen in mm (Länge x Höhe)		
Platine	167,65 x 64,41	312,00 x 106,68
Low Profile Metallschiene	181,36 x 80,06	
Metallschiene	180,96 x 120,88	
Metallschiene ohne Haltebügel		325,31 x 126,37
Metallschiene und Haltebügel		352,17 x 126,37
Datenübertragungsrate	max. 2, 4 oder 8 x 56 kBit/s je nach Modell	
Plug&Play	ja	
Stromsparmmodus		
Anschlussbuchsen	2 x RJ-10	Alle Analog-4: 4 x RJ-10 Alle Analog-8: 4 x RJ-45
Anschlussart	2, 4 oder 8 x analoge V.90 Schnittstelle je nach Kartentyp	
Stromverbrauch	0,34 A @ +5 V typ.	Alle Analog-4: 0,45 A @ +5 V typ. Alle Analog-8: 0,5 A @ +5 V typ.



	<b>Diva UM-Analog-2 PCIe Diva Analog-2 PCIe</b>	<b>Diva UM-Analog-4 PCIe Diva UM-Analog-8 PCIe Diva Analog-4 PCIe Diva Analog-8 PCIe</b>
Busformat	PCIe 1.0a x1 Lane	
Prozessor	32 Bit RISC CPU, 100 MHz	
Speicher auf der Karte	16 MB SDRAM	
IRQs (Interrupt Request Level)	Vom PC BIOS zugewiesen	
I/O-Basisadressen (hex)		
Gemeinsamer Speicher	16 MB (Speicher)	
DSPs	2, 4 oder 8 ADSP 2185 je nach Kartentyp	
Abmessungen in mm (Länge x Höhe)		
Platine	167,65 x 68,90	167,65 x 111,15
Low Profile Metallschiene	181,38 x 80,06	
Metallschiene	180,96 x 120,88	180,96 x 126,31
Datenübertragungsrate	max. 2, 4 oder 8 x 56 kBit/s je nach Modell	
Plug&Play	ja	
Stromsparmmodus		
Anschlussbuchsen	2 x RJ-10	Alle Analog-4: 4 x RJ-10 Alle Analog-8: 4 x RJ-45
Anschlussart	2, 4 oder 8 x analoge V.90 Schnittstelle je nach Kartentyp	
Stromverbrauch	0,26 A @ 3,3V typ. 0,16 A @ 12V typ.	Alle Analog-4: 0,26 A @ 3,3V typ. 0,18 A @ 12V typ.  Alle Analog-8: 0,34 A @ 3,3V typ. 0,22 A @ 12V typ.

## Zulassungsinformationen

Dialogic Corporation erklärt, dass diese Telekommunikationsendeinrichtungen den grundlegenden Anforderungen und anderen relevanten Bestimmungen der Richtlinie 1999/5/EG entspricht.

### Internationale Zulassungen

Diva Karten sind in Europa (CE Kennzeichnung) und in Nordamerika (FCC und Industry Canada) zertifiziert.

Die Zertifizierung in Europa beinhaltet nur die Länder, die das Zulassungskennzeichen der Europäischen Union (CE Kennzeichnung) akzeptieren: Belgien, Dänemark, Deutschland, Estland, Finnland, Frankreich, Griechenland, Großbritannien, Irland, Island, Italien, Lettland, Litauen, Luxemburg, Niederlande, Norwegen, Österreich, Polen, Portugal, Schweden, Schweiz, Slowakei, Slowenien, Spanien, Tschechische Republik, Ungarn und Zypern.

Einige osteuropäische Länder und Mittelmeer-Länder akzeptieren das CE-Kennzeichen ebenfalls. Wenn Sie sich nicht sicher sind, wenden Sie sich an Ihren Fachhändler, die zuständige Telefongesellschaft oder die Zulassungsbehörde.

Ausführliche Zulassungsinformationen finden sie unter:

<http://www.dialogic.com/declarations>.

## Kundendienst

Dialogic stellt Ihnen verschiedene Möglichkeiten zur Verfügung, technischen Support zu erhalten. Falls beim Betrieb Ihrer Karte Probleme auftreten sollten, nutzen Sie unsere Support Tools bevor Sie sich an Ihren Fachhändler wenden. Außerdem können Sie einen Blick in unsere Services & Support Internetseite zu werfen. Für den unwahrscheinlichen Fall, dass Ihnen weder die Services & Support Internetseite noch der Fachhändler weiterhelfen können, können Sie den Dialogic Kundendienst kontaktieren. Für weitere Informationen sehen Sie:

- [Dialogic® Diva® Support Tools](#) unten
- [Dialogic Services & Support Internetseite](#) unten
- [Dialogic Kundendienst](#) auf Seite 124

## Dialogic® Diva® Support Tools

Falls ein Problem mit Ihrer Dialogic® Diva® Karte auftreten sollte, benutzen Sie die folgenden Diva Support Tools (nur für Windows® Betriebssysteme):

- Dialogic® Diva® Line Test Tool: Mit dem Diva Line Test Tool können sie einfach eingehende oder ausgehende Rufe oder Rufweiterleitungen testen.
- Dialogic® Diva® Diagnostics Tool: Mit dem Diva Diagnostics Tool können Sie Tracedateien für jede Diva Karte oder jeden Treiber aufzeichnen und in einer Datei speichern.
- Dialogic® Diva® Management Tool: Mit dem Diva Management Tool können Sie sich den aktuellen Status der angeschlossenen Leitungen, die aktiven Verbindungen und die Historie der Verbindungen ansehen.

Für weitere Information zu diesen Tools sehen Sie die jeweilige Online-Hilfe.

Wenn Sie das Problem nicht mit Hilfe der Support Tools beheben können, können Sie sich an Ihren Fachhändler wenden.

## Dialogic Services & Support Internetseite

Wenn Sie zusammen mit Ihrem Fachhändler das Problem nicht beheben konnten, können Sie die Dialogic Services & Support Internetseite besuchen. Es enthält:

- detaillierte Informationen zum Dialogic® Pro™ Service (Serviceverträge über 1, 3 oder 5 Jahre mit rund-um-die-Uhr Erreichbarkeit) unter: <http://www.dialogic.com/support/DialogicPro/>
- Informationen zum Help Web für viele Dialogic® Produkte unter: <http://www.dialogic.com/support/helpweb>
- eine Downloadseite zum Installieren der neuesten Version Ihrer Software unter: <http://www.dialogic.com/support/downind.asp>

- Informationen über Online- oder Vorortschulungen unter: <http://www.dialogic.com/training/default.htm>
- einen Link zur Hard- und Software Dokumentation unter: <http://www.dialogic.com/manuals/default.htm>
- technische Foren über verschiedene entwicklerspezifische Fragen unter: <http://www.dialogic.com/forums/category-view.asp>
- Informationen zur Dialogic Kundendienstseite. Für weitere Informationen, zum Kontaktieren des Kundendienstes, sehen Sie den folgenden Abschnitt.

## Dialogic Kundendienst

Beachten Sie bei Problemen mit Ihrer Dialogic® Diva® Karte und der Software die Vorschläge und Empfehlungen auf der Services & Support Internetseite, bevor Sie sich mit dem Kundendienst in Verbindung setzen.

Der Kundendienst benötigt von Ihnen ggf.:

- ein Debug-Trace. Für Windows-Betriebssystem sehen Sie die Dialogic® Diva® Diagnostics Online-Hilfe (DivaTrace.chm) auf Ihrer Dialogic® Diva® System Release WIN Software CD-ROM. Für Linux sehen Sie den Dialogic® Diva® System Release LIN Reference Guide.
- oder eine Kopie Ihrer aktiven Konfiguration, wenn Sie Ihre Diva Karte unter Windows einsetzen. Sehen Sie dazu die Dialogic® Diva® Configuration Manager Online-Hilfe (DSMain.chm).

Zur Kontaktaufnahme mit dem Dialogic Kundendienst sehen Sie [www.dialogic.com/support/contact](http://www.dialogic.com/support/contact).

## Umweltinformationen für Ihr Dialogic® Produkt

Im August 2005 trat die Richtlinie 2002/96/EG über Elektro- und Elektronik-Altgeräte (WEEE) und deren Ergänzung 2003/108/EG in den meisten Ländern der Europäischen Union in Kraft. Diese Richtlinie gilt auch für das von Ihnen erworbene Dialogic Produkt.

Wir sind überzeugt, dass Ihnen unser Produkt über viele Jahre zuverlässige Dienste leisten wird. Wenn das Produkt, nach vielen Jahren des erfolgreichen Einsatzes, nicht mehr Ihren Ansprüchen gerecht werden sollte oder die Reparaturkosten zu hoch werden sollten, bitten wir Sie, es nicht über den Hausmüll zu entsorgen sondern einer Verwertung zuzuführen, da die Materialien wiederverwertet werden können.

Dialogic hat viel Aufwand bei Design und Herstellung der Karte investiert, um die Umweltbelastung so gering wie möglich zu halten. Wir bitten Sie, Ihren Teil zur Umweltschonung beizutragen, indem Sie die Karte nicht über den Hausmüll entsorgen sondern recyceln, denn sie enthält Wertstoffe die effizient wiederverwertet werden können.

Wie alle elektrischen und elektronischen Produkte, einschließlich Fernsehgeräte und Computer, kann dieses Produkt einen geringen Anteil an Werkstoffen enthalten, die Umweltschäden hervorrufen können. Um solche Schäden zu vermeiden, bitten wir Sie eine der folgenden Möglichkeiten der Entsorgung zu nutzen:

- Sammelstelle Ihrer Firma,
- lokale Wertstoffannahmestelle oder
- Abgabe beim Händler des Ersatzproduktes.

Für das Entsorgen des Produktes innerhalb der Europäischen Union fallen für Sie keine Kosten an, da wir, mit Markteinführung der Karte, für die Entsorgung bezahlt haben. Das sind die Anforderungen der WEEE Richtlinie.





## Adaptadores Dialogic® Diva® Guía de Instalación

Los adaptadores Dialogic® Diva® permiten establecer enlaces de alta velocidad a través de accesos básicos RDSI ( $S_0$ ), accesos primarios ( $S_{2M}$ ) o accesos analógicos para una gran variedad de aplicaciones. Esta guía de instalación describe como instalar y conectar físicamente su adaptador Diva, provee datos técnicos y una vista general de la documentación online.

## Adaptadores Dialogic® Diva® disponibles

El rango de productos Diva abarca los siguientes adaptadores:

### Adaptadores Dialogic® Diva® BRI

Los adaptadores Diva BRI son adaptadores RDSI para servidores que proporcionan conexiones tanto digital como analógicas para uno o cuatro Interfaces de Acceso Básico (BRI) de la RDSI.

#### Div a BRI PCI:

- Diva BRI-CTI
- Diva BRI-2FX
- Diva BRI-2
- Diva 4BRI-8
- Diva UM-BRI-2
- Diva UM-4BRI-8

#### Div a BRI PCIE:

- Diva BRI-2 PCIE
- Diva 4BRI-8 PCIE
- Diva UM-BRI-2 PCIE
- Diva UM-4BRI-8 PCIE

### Adaptadores Dialogic® Diva® PRI, E1 y T1

Los adaptadores Diva de servidor aportan conectividad hasta 30 canales sobre líneas RDSI PRI (Primary Rate Interface), E1 y T1.

#### Div a PRI PCI:

- Diva PRI/E1/T1-CTI
- Diva PRI/E1/T1-8
- Diva PRI/E1-30
- Diva UM-PRI/E1-30

#### Div a V-PRI PCI:

- Diva V-PRI/E1-30

#### Div a V-xPRI PCI:

- Diva V-2PRI/E1-60
- Diva V-4PRI/E1-120

### Notas para adaptadores Diva V-xPRI PCIe:

- La abreviación "HS" significa "half size" (medio tamaño). Para las medidas exactas, véase la página 159. Estos adaptadores pueden ser aprobados en algunos países con el nombre del tipo de equipo "VPRIHS".
- La abreviación "FS" significa "full size" (tamaño completo). Para las medidas exactas, véase la página 160. Estos adaptadores pueden ser aprobados en algunos países con el nombre del tipo de equipo "VPRIHS" o con los nombres de sus modelos "Diva V-4PRIFS" y "Diva V-8PRIFS".

#### **Diva PRI PCIe:**

- Diva PRI/E1/T1-CTI PCIe
- Diva PRI/E1-30 PCIe

#### **Diva V-PRI PCIe:**

- Diva V-PRI/E1-30 PCIe

#### **Diva V-xPRI PCIe:**

- Diva V-1PRI/E1/T1-30 PCIe HS
- Diva V-2PRI/E1/T1-60 PCIe HS
- Diva V-4PRI/E1/T1-120 PCIe HS
- Diva V-4PRI/E1/T1-120 PCIe FS
- Diva V-8PRI/E1/T1-240 PCIe FS

### Adaptadores Dialogic® Diva® Analog

Los adaptadores Diva Analog son adaptadores de comunicaciones que ofrecen soporte para aplicaciones de voz, fax y acceso remoto para dos, cuatro u ocho conexiones simultáneas a través de líneas analógicas.

#### **Diva Analog PCI**

- Diva Analog-2
- Diva Analog-4
- Diva Analog-8
- Diva UM-Analog-2
- Diva UM-Analog-4
- Diva UM-Analog-8

#### **Diva Analog PCIe**

- Diva Analog-2 PCIe
- Diva Analog-4 PCIe
- Diva Analog-8 PCIe
- Diva UM-Analog-2 PCIe
- Diva UM-Analog-4 PCIe
- Diva UM-Analog-8 PCIe



## Sistemas Operativos

Se puede utilizar los adaptadores Dialogic® Diva® con los siguientes sistemas operativos:

- Linux (la mayoría de los kernels y distribuciones conocidos)
- Microsoft® Windows® 7
- Microsoft® Windows Server® 2008
- Microsoft® Windows Vista®
- Microsoft® Windows Server® 2003
- Microsoft® Windows® XP

**Nota:** El adaptador Dialogic® Diva® BRI and UM-BRI también puede utilizarse en PCs que dispongan del sistema operativo Microsoft® Windows® Small Business Server (SBS). El software y la documentación se encuentran en el correspondiente CD-ROM de Microsoft® Windows® Small Business Server.

## Dialogic® Diva® Documentación Online

La documentación online se encuentra con los drivers del Dialogic® Diva® System Release y/o en la página web de Dialogic. La documentación online describe la instalación y configuración del Diva software. Para ver la documentación en la página web, véase nuestro sitio de manuales (en inglés) en <http://www.dialogic.com/manuals/default.htm>.

## Instrucciones de Seguridad

Aplique las siguientes instrucciones de seguridad para garantizar su propia seguridad personal y para ayudarle a proteger el PC y su entorno de trabajo contra posibles daños.

### **PRECAUCIÓN Para todos los adaptadores Dialogic® Diva®**



Todos los PCs que tienen instalados adaptadores Diva, deben cumplir con las regulaciones específicas de seguridad del país, tales como la CE o FCC, para evitar daños personales y del PC y/o del adaptador Diva.

Asegúrese de que el cable RDSI o analógico no está conectado con la RDSI o la red analógica antes de abrir la caja del PC para evitar daños personales, del PC y/o del adaptador Diva.

Siempre coloque el tornillo en la barra metálica del adaptador Diva para que éste quede firmemente sujeto al chasis del PC. De este modo se garantiza una puesta a tierra correcta y se evitan posibles daños.

Nunca instale un contacto telefónico en un lugar húmedo.

Nunca toque las terminales ni el cableado telefónico sin aislar a menos que el cableado telefónico haya sido desconectado en la interface de la red.

Tenga cuidado al instalar o modificar las líneas telefónicas.

Telephone companies report that electrical surges, typically lightning transients, are very destructive to customer terminal equipment connected to AC power sources. The use of a surge arrester on the AC line is recommended.

Las compañías telefónicas reportan que sobretensiones, normalmente causado por rayos, son muy destructivos a equipos conectados a la corriente alterna. Se recomienda el uso de una protección contra sobretensiones en la línea de corriente alterna.

### **Adaptadores Dialogic® Diva® BRI y PRI, excepto Dialogic® Diva® V-xPRI PCIe HS und V-xPRI PCIe FS**

Las señales BRI y PRI pueden tener voltajes de la red telefónica. Por eso, las líneas de RDSI BRI, PRI y E1 deben ser instalados y mantenidos solamente por personal autorizado. Si el PC no es conectada y puesta a tierra correctamente, puede resultar en daños personales, del PC y/o del adaptador Diva. Esto aplica particularmente para usuarios en Norteamérica y Australia.

**PRECAUCIÓN Adaptadores Dialogic® Diva® V-xPRI PCIe HS y V-xPRI PCIe FS**

Los adaptadores V-xPRI PCIe HS y V-xPRI PCIe FS no tienen voltajes de la red telefónica, porque son productos de seguridad de voltaje muy bajo (SELV).

**Adaptadores Dialogic® Diva® V-2PRI PCI, V-4PRI PCI, V-4PRI FS PCIe y V-8PRI FS PCIe**

Los adaptadores V-2PRI y V-4PRI pueden requerir una potencia de aproximadamente 20 vatios.

Los adaptadores V-4PRI FS PCIe y V-8PRI FS PCIe pueden requerir una potencia de aproximadamente 24 vatios.

En caso de instalar varios adaptadores en su sistema, asegúrese de que la alimentación eléctrica no sufra sobrecargas con la instalación del adaptador. Asegúrese también de que el PC tiene suficiente ventilación para evitar daños del mismo.

**IMPORTANTE Adaptadores Dialogic® Diva® BRI y PRI**

Los adaptadores Diva BRI y PRI han sido sometidos a una prueba de funcionamiento y cumplen con todos los requisitos de compatibilidad electromagnética, seguridad y compatibilidad de la interfaz RDSI impuestos por las Directivas de la UE y por las normativas vigentes en Norteamérica y otros espacios económicos importantes. Antes de instalar y utilizar el adaptador, lea la información dada en [Homologaciones internacionales](#) en la página 163.

Los cables para los puertos de los interfaces PRI tienen que ser apantallados.

**Adaptadores Dialogic® Diva® PRI PCIe y V-xPRI PCI y PCIe**

El funcionamiento adecuado de los adaptadores Diva PRI PCIe y Diva V-xPRI PCI y PCIe está garantizado solamente si son operados dentro del rango de temperatura permitido, véase la página 153 para más información. Si se excede la temperatura máxima, se crea un archivo de depuración con información de las temperaturas alcanzadas.

**Adaptadores Dialogic® Diva® Analog**

Solamente utilice cables de telecomunicación con American Wire Gauge (AWG) número 26 o superior.

## Preparativos

En primer lugar, asegúrese de que tiene a mano todos los componentes necesarios para la instalación del adaptador Dialogic® Diva® y del software:

Componentes	Descripción
PC	<p>El PC debe disponer de lo siguiente:</p> <ul style="list-style-type: none"> <li>• Una ranura PCI libre para adaptadores de bus PCI (para Dialogic® Diva® V-2PRI und V-4PRI según PCI 2.2)</li> <li>• Una ranura PCI Express x1 o x4 libre, 1.0a compatible para adaptadores de bus PCIe Se pueden usar otras ranuras de tipo PCIe, p.ej. x4, x8, x16, si son soportados por el sistema operativo.</li> </ul> <p><b>Nota:</b> La ranura PCI Express x4 solamente se necesita para instalar los adaptadores Dialogic® Diva® V-4PRI PCIe FS y V-8PRI PCIe FS.</p> <ul style="list-style-type: none"> <li>• Un sistema operativo instalado: Linux, Microsoft® Windows® 7 Microsoft® Windows Server® 2008, Microsoft® Windows Vista®, Microsoft® Windows Server® 2003, Microsoft® Windows® XP</li> <li>• Como mínimo 15 MB de memoria libre en el disco duro para el Dialogic® Diva® System Release</li> </ul>
Adaptador RDSI Dialogic® Diva®	<p>El paquete Dialogic® Diva® RDSI incluye los siguientes componentes:</p> <ul style="list-style-type: none"> <li>• Adaptador Dialogic® Diva® BRI o PRI</li> <li>• Uno o varios cables de enlace RJ-45 RDSI (solamente para adaptadores Diva BRI)</li> <li>• Adaptador Dialogic® Diva® V-8PRI PCIe FS: cuatro cables con dispositivo</li> <li>• Adaptadores Dialogic® Diva® Guía de Instalación</li> </ul>
Adaptador Dialogic® Diva® Analog	<p>El paquete Diva Analog incluye los siguientes componentes:</p> <ul style="list-style-type: none"> <li>• Adaptador Diva Analog</li> <li>• cables para conectar el adaptador a la línea analógica</li> <li>• Adaptador Diva Analog-8 y V-Analog-8: cuatro cables con dispositivo</li> <li>• Adaptadores Diva Guía de Instalación</li> </ul>
Cables	<p>Los cables de enlace RJ-45 no están incluidos en el paquete de los adaptadores Dialogic® Diva® PRI y es necesario solicitarlos con un distribuidor de cables.</p>
CSU/DSU	<p>Los adaptadores Dialogic® Diva® V-1PRI PCIe HS, V-2PRI PCIe HS, V-4PRI PCIe HS, V-4PRI PCIe FS y V-8PRI PCIe FS no llevan integrada una CSU/DSU (Channel Service Unit/Data Service Unit). Es necesario solicitar una CSU/DSU externa con un distribuidor y conectarla. Para más información véase <a href="#">Conectar la línea primaria</a> en la página 137.</p>

Componentes	Descripción
Acceso RDSI básico (S <sub>0</sub> ), primario (S <sub>2M</sub> ) o analógico	Los accesos son instalados por la compañía telefónica responsable. Asegúrese de que le instalen el acceso adecuado para el adaptador Dialogic® Diva®.
Información sobre el acceso	Su compañía telefónica debe suministrarle la siguiente información: <ul style="list-style-type: none"> <li>• Números para cada línea RDSI o analógica.</li> <li>• Protocolo de transmisión RDSI (protocolo de canal D): El protocolo depende normalmente de la región. El protocolo más conocido es Euro-RDSI DSS1 (se utiliza en Europa y también se denomina estándar ETSI).</li> </ul>

## Instalación

Usted debe completar los tres siguientes procedimientos, para utilizar su adaptador Dialogic® Diva® apropiadamente:

- (A) Insertar el adaptador Diva en el PC siguiendo la descripción dada abajo.
- (B) Conectar la línea siguiendo la descripción dada en la página 135.
- (C) Instalar el software para el adaptador Diva siguiendo la descripción dada en la página 146.

**Nota:** Usted puede requerir el manual de su PC durante la instalación de su adaptador.

### (A) Insertar el adaptador Dialogic® Diva® en el PC

1. Desconecte el PC y todas las unidades periféricas para evitar posibles daños.
2. Elimine la carga estática de su cuerpo tocando el chasis metálico (el metal sin pintar que está en la parte posterior del PC).
3. Desenchufe el cable RDSI y el cable de alimentación del PC.
4. Retire la cubierta exterior del PC (véase el manual del PC).
5. Busque una ranura PCI libre en el PC.
6. Si hay una placa metálica en el extremo de la ranura, retire el tornillo o afloje el clip y retire la placa metálica. Guarde el tornillo para fijar el adaptador como se describe en paso 10 en la página 134.

7. Si el adaptador tiene un estribo de sujeción, lo puede retirar si dificulta la instalación, pues sólo sirve de ayuda mecánica y no influye el funcionamiento del adaptador.

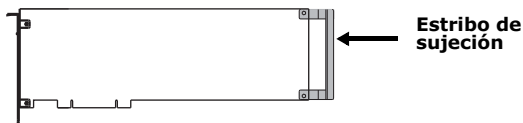

8. Antes de insertar el adaptador lea la siguiente norma de seguridad:

**NORMA DE SEGURIDAD:**



Para no dañar el hardware, es imprescindible instalar el adaptador en una ranura PCI. Si instala el adaptador Dialogic® Diva® en una ranura de un tipo diferente, se puede dañar el adaptador, el PC o ambos.

9. Inserte el adaptador en la ranura. Asegúrese de que el adaptador no hace contacto ni con la CPU, ni con los módulos de memoria y con ningún otro componente de la placa.

**Nota:** Adicionalmente al bus PCI, los adaptadores Dialogic® Diva® V-2PRI y V-4PRI cuentan con un bus H.100 en la tarjeta. El bus H.100 no es operacional, por lo tanto, solamente inserte el adaptador con el bus PCI en el PC.

**Tornillo**

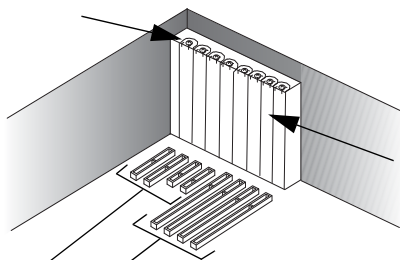

**Placas metálicas**

**Ranuras PCIe Ranuras PCI**

10. Fije el adaptador con el tornillo o el clip para que quede bien sujeto al chasis del PC.

**NORMA DE SEGURIDAD:**



No se olvide de colocar el tornillo en la barra metálica del adaptador Diva para que éste quede firmemente sujeto al chasis del PC. De este modo se garantiza una puesta a tierra correcta y se evitan posibles daños.

11. Vuelva a montar la cubierta exterior del PC (véase el manual del PC).

## (B) Conectar la línea

La manera de conectar su adaptador depende del tipo de adaptador Diva que tenga:

- Si tiene un adaptador Dialogic® Diva® BRI, siga la descripción dada abajo.
- Si tiene un adaptador Dialogic® Diva® PRI, siga la descripción dada en la página 137.
- Si tiene un adaptador Dialogic® Diva® Analog, siga la descripción dada en la página 142.

### Conectar la línea RDSI básica

**Nota:** Si pretende utilizar su adaptador Dialogic® Diva® BRI como terminación de red para su conexión a centralitas o directamente a otro adaptador Diva, acuda a la página 136.

*En Europa y en la mayoría de los países del mundo:*

En Europa y en la mayoría de los demás países del mundo, excepto Norteamérica y Japón, el adaptador Diva se puede conectar directamente a la línea RDSI con el cable suministrado.

**1. Utilice el cable RDSI suministrado y enchufe un extremo del cable en el adaptador RDSI.**

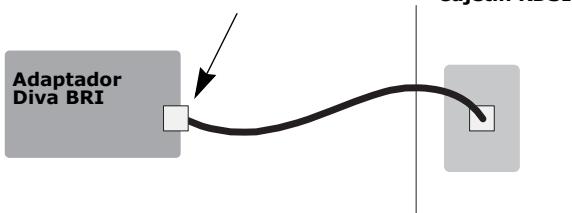

**2. Enchufe el otro extremo del cable en el cajetín RDSI.**

### Nota para todos los adaptadores Dialogic® Diva® 4BRI:

Los adaptadores Diva 4BRI tienen cuatro puertos para conectar a cuatro accesos básicos RDSI independientes. Conecte los cuatro cables suministrados como se muestra en la figura arriba. Los puertos se pueden usar indistintamente aunque, por regla general, es necesario especificar el número de puerto a la hora de configurar el software. Observe en la figura abajo los números de puerto. En la figura, el conector de enchufe del adaptador señala hacia abajo.



**Conexión de adaptadores Dialogic® Diva® BRI en modo TR:**

El Dialogic® Diva® System Release permite configurar los adaptadores Diva BRI como terminaciones de red (TR). Esto significa que su adaptador puede actuar como TR, por ejemplo, para interconexión de centralitas con protocolo Q-Sig o para una conexión directa a otro adaptador Diva.

Cuando se conecta el adaptador a una centralita que actúa como equipo terminal y, por tanto, requiere un TR que proporcione la señal de reloj, configure el adaptador como TR. Conecte el adaptador a la centralita tal como se muestra en el diagrama inferior con la asignación de conectores apropiada. Utilice las resistencias terminales necesarias.

Cuando utilice dos adaptadores Diva para conexión directa entre sí, configure un adaptador como TR y el otro como TE. Conecte los adaptadores con un cable cruzado. El cableado debe corresponderse al diagrama inferior y el cable debe incorporar las resistencias terminales necesarias.

Asignación de contactos para clavijas de 8 conectores:

Conectores RJ-45	Lado TE		Cableado	Lado TR	
	Hilo	Señales		Hilo	Señales
1	no utilizado			1a	TX +
2	no utilizado			2a	RX +
3	2a	TX +		2b	RX -
4	1a	RX +		1b	TX -
5	1b	RX -			
6	2b	TX -			
7	no utilizado				
8	no utilizado				

Resistencias terminales  
100 Ohm, 5%



**Nota:** Mirando el conector RJ-45 con los conectores expuestos hacia usted, se numeran de 1 a 8 de izquierda a derecha (v. fig.).

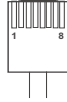

## Conectar la línea primaria

**Nota:** Los adaptadores Dialogic® Diva® PRI, excepto los adaptadores Dialogic® Diva® V-xPRI PCIe HS y Dialogic® Diva® V-xPRI PCIe FS, llevan integrada una CSU (Channel Service Unit) que le protege de los daños que pueden provocar los impulsos de corriente. No obstante, también puede utilizar una CSU externa que le permita controlar la línea RDSI.

Utilice un cable RJ-45. El cable a utilizar depende del uso que quiera darle:

- RJ-45 a RJ-45 para conexión a una línea RDSI PRI con conexión RJ-45 o para una conexión como terminación de red a una centralita.
- RJ-45 a cables abiertos para conexión a una línea RDSI PRI con hilos abiertos o para conexión entre dos adaptadores Diva.

*Si el acceso RDSI tiene un cajetín RJ-45:*

Utilice el cable con conectores RJ-45 en ambos extremos:

Adaptador Diva PRI	Señal	Conector RJ-45
Pin 1	Receive + (RX +)	Pin 1
Pin 2	Receive - (RX -)	Pin 2
Pin 4	Transmit + (TX +)	Pin 4
Pin 5	Transmit - (TX -)	Pin 5
Conector apantallado	Totalmente apantallado	Conector apantallado

**Nota:** Para el modo E1 con impedancia de 75 ohmios, utilice un adaptador Balun externo de 75 ohmios. Dicho adaptador se puede adquirir en cualquier comercio especializado.

La manera de conectar su adaptador Diva depende del tipo de adaptador que usted tenga:

- Para conectar todos los adaptadores Dialogic® Diva® PRI, excepto Dialogic® Diva® V-8PRI PCIe FS, siga la descripción que se indica abajo.
- Para conectar el adaptador Dialogic® Diva® V-8PRI PCIe FS, siga la descripción que se indica en la página 139.

**Conecte el adaptador Dialogic® Diva® PRI (excepto Diva V-8PRI PCIe FS) a la RDSI tal como se muestra en la figura:**

**1. Utilice un cable RDSI y enchufe un extremo del cable en el adaptador RDSI.**

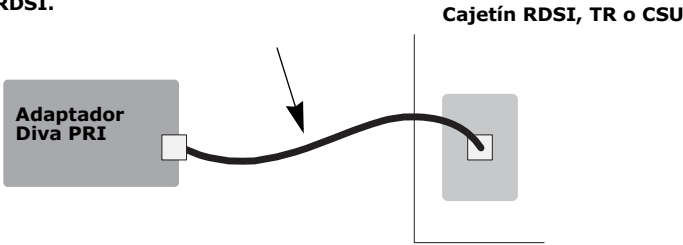

**2. Enchufe el otro extremo del cable en el cajetín RDSI o la CSU.**

**Nota para los adaptadores Dialogic® Diva® V-2PRI y Diva V-4PRI:**

Los adaptadores Diva V-2PRI tienen dos puertos y los adaptadores Diva V-4PRI tienen cuatro puertos para conectar a cuatro accesos primarios RDSI independientes. Conecte los cables tal y como se muestra en la figura arriba. Los puertos se pueden usar indistintamente aunque, por regla general, es necesario especificar el número de puerto a la hora de configurar el software. Observe en la figura abajo los números de puerto. En la figura, el conector de enchufe del adaptador señala hacia abajo.

**Diva V-2PRI**



**Diva V-4PRI**



**Nota para los adaptadores Dialogic® Diva® V-1PRI PCIe HS, Diva V-2PRI PCIe HS, Diva V-4PRI PCIe HS y Diva V-4PRI PCIe FS:**

Los adaptadores Diva V-xPRI PCIe HS y Diva V-4PRI PCIe FS tienen cuatro puertos. La "x" o el "4" en el nombre determina los puertos activados, es decir, el adaptador Diva V-1PRI HS tiene un puerto activado, el Diva V-2PRI HS tiene dos puertos activados y el Diva V-4PRI HS y Diva V-4PRI FS tiene cuatro puertos activados (véase figura abajo). Solamente puede utilizar los puertos

activados. En la figura, el conector de enchufe del adaptador señala hacia abajo. Por regla general, es necesario especificar el número de puerto a la hora de configurar el software.

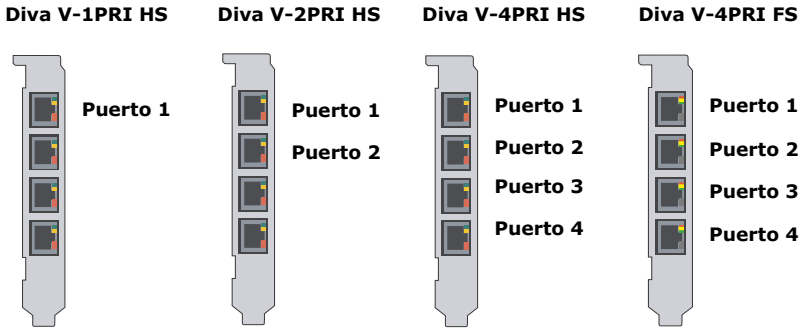

**Nota:** Los adaptadores Diva V-1PRI PCIe HS, V-2PRI PCIe HS, V-4PRI PCIe HS y V-4PRI PCIe FS no llevan integrada una CSU/DSU (Channel Service Unit/Data Service Unit). Es necesario solicitar una externa con un distribuidor y conectarla.

### Adaptador Dialogic® Diva® V-8PRI PCIe FS

Todos los adaptadores Diva V-8PRI PCIe FS tienen cuatro puertos RJ-45 para conectar a cuatro dispositivos. Cada dispositivo tiene dos puertos. Así que un puerto del adaptador representa a dos puertos en el cajetín o la centralita. Los puertos se pueden usar indistintamente aunque, por regla general, es necesario especificar el número de puerto a la hora de configurar el software. Observe en la figura abajo los números de puerto. En la figura, el conector de enchufe del adaptador señala hacia abajo.



**Nota:** Los adaptadores Diva V-8PRI PCIe FS no llevan integrada una CSU/DSU (Channel Service Unit/Data Service Unit). Es necesario solicitar una externa con un distribuidor y conectarla.

**Conecte el adaptador Diva V-8PRI PCIe FS a la RDSI tal como se muestra en la figura:**

**1. Utilice los cuatro cables con dispositivo y enchufe los conectores RJ-45 en el adaptador.**

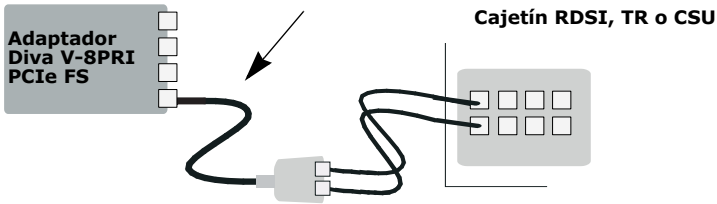

**2. Utilice los ocho cables y enchufe los conectores RJ-45 en el dispositivo. El puerto "A" corresponde a los puertos 1,2,3 y 4. El puerto "B" corresponde a los puertos 5,6,7 y 8.**

**3. Enchufe los ocho conectores RJ-45 en el cajetín.**

Utilice el cable con el dispositivo:

RJ45	Señal	Dispositivo con conectores RJ-45	Señal	
Pin 1	Receive + (RX +) (Puerto A)	Puerto A	Pin 1	Receive + (RX +)
Pin 2	Receive - (RX -) (Puerto A)		Pin 2	Receive - (RX -)
Pin 3	Receive + (RX +) (Puerto B)		Pin 4	Transmit + (TX +)
Pin 4	Transmit + (TX +) (Puerto A)		Pin 5	Transmit - (TX -)
Pin 5	Transmit - (TX -) (Puerto A)	Puerto B	Pin 1	Receive + (RX +)
Pin 6	Receive - (RX -) (Puerto B)		Pin 2	Receive - (RX -)
Pin 7	Transmit + (TX +) (Puerto B)		Pin 4	Transmit + (TX +)
Pin 8	Transmit - (TX -) (Puerto B)		Pin 5	Transmit - (TX -)

**Nota:** Mirando el conector RJ-45 con los conectores expuestos hacia usted, se numeran de 1 a 8 de izquierda a derecha (v. fig.).

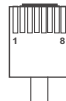

*Si el adaptador Dialogic® Diva® PRI en modo TR está conectado a una centralita:*

El software Dialogic® Diva® System Release permite configurar los adaptadores Diva PRI como terminaciones de red (TR). Esto significa que su adaptador puede actuar como TR para centralitas que actúan como equipo terminal y, por tanto, requieren un TR que proporcione la señal de reloj. Por ejemplo, el adaptador Diva puede actuar como TR en la interconexión de centralitas con protocolo Q-Sig.

Cuando se conecta el adaptador a una centralita que actúa como TE, configure el adaptador como TR. Conecte el adaptador a la centralita tal como se muestra en el diagrama de la página 142 con la asignación de conectores apropiada.

*Si la TR tiene alambres sueltos:*

En determinados casos hay que conectar el adaptador Diva PRI a una terminación de red (TR) sin cajetín. Los cables de transmisión (TX) y recepción (RX) se reconocen por sus colores; los cables de transmisión son de color azul y blanco-azul mientras que los de recepción son de color naranja y blanco-naranja.

Utilice el cable RDSI con los extremos abiertos:

Adaptador Diva PRI	Señal	Extremos abiertos
Pin 1	Receive + (RX +)	Blanco-naranja
Pin 2	Receive - (RX -)	Naranja
Pin 4	Transmit + (TX +)	Azul
Pin 5	Transmit - (TX -)	Blanco-azul
Conector apantallado	Totalmente apantallado	Apantallamiento

Asegúrese de que las líneas de transmisión del adaptador Diva PRI quedan unidas a las conexiones de recepción de la TR y las líneas de recepción del adaptador Diva PRI a las conexiones de transmisión de la TR.

**Nota:** Si el adaptador Diva PRI no está bien conectado a la RDSI, se ilumina un piloto de advertencia de nivel 1 tanto en la TR como en la centralita de la compañía telefónica. En caso de utilizar una CSU externa, también se ilumina un piloto de advertencia en la CSU. En dicho caso, lo más probable es que la compañía telefónica desactive la línea que después tendrá que volver a activar manualmente. Para tal finalidad, es necesario que informe al centro de averías de su compañía telefónica.

Si el adaptador Dialogic® Diva® PRI va a conectarse directamente a otro adaptador:

El software Dialogic® Diva® System Release permite configurar los adaptadores Diva PRI como terminaciones de red (TR). Esto significa que puede utilizar dos adaptadores Diva para una conexión directa entre sí.

Cuando utilice dos adaptadores Diva para conexión directa entre sí, configure un adaptador como TR y el otro como TE. Conecte los adaptadores con un cable cruzado. Puede hacerlo usted mismo utilizando un cable abierto por uno de sus extremos. Conecte los hilos del extremo abierto como se describe en el lado TR del diagrama inferior:

	Lado TE		Lado TR	
Conectores RJ-45	Señales	Cableado	Señales	
1	RX +		RX +	
2	RX -		RX -	
3 no utilizado				
4	TX +		TX +	
5	TX -		TX -	
6 no utilizado				
7 no utilizado				
8 no utilizado				

**Nota:** Mirando el conector RJ-45 con los conectores expuestos hacia usted, se numeran de 1 a 8 de izquierda a derecha (v. fig.).



### Conectar la línea analógica

Utilice los cables incluidos con el adaptador Dialogic® Diva®. La manera de conectar su adaptador Diva depende del tipo de adaptador que usted tenga:

- Si conecta un adaptador Dialogic® Diva® Analog-2, siga la descripción que se indica en la página 143.
- Si conecta un adaptador Dialogic® Diva® Analog-4 o Diva V-Analog-4, siga la descripción que se indica en la página 144.
- Si conecta un adaptador Dialogic® Diva® Analog-8 o Diva V-Analog-8, siga la descripción que se indica en la página 145.

**Importante:** Solamente utilice cables de telecomunicación como mínimo con número 26 AWG (American Wire Gauge).

ESPAÑOL

### Adaptador Dialogic® Diva® Analog-2:

Los adaptadores Diva Analog-2 tienen dos puertos RJ-10 para conectar a dos accesos analógicos independientes. Los puertos se pueden usar indistintamente aunque, por regla general, es necesario especificar el número de puerto a la hora de configurar el software. Observe en la figura abajo los números de puerto. En la figura, el conector de enchufe del adaptador señala hacia abajo.



Conecte el adaptador Diva Analog-2 como se muestra en la figura:

1. Utilice los dos cables suministrados y enchufe los dos conectores RJ-10 en el adaptador analógico.

Cajetín analógico o centralita

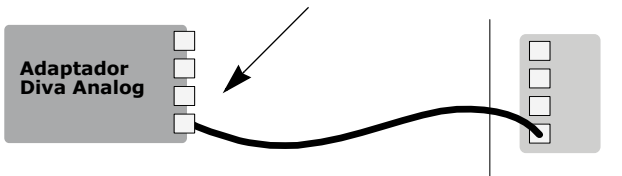

2. Enchufe los dos conectores RJ-11 en el cajetín analógico o la centralita.

Asignación de contactos:

RJ-10	Señal	RJ-11
Pin 2	Ring	Pin 3
Pin 3	Tip	Pin 4

**Nota:** Mirando los conectores RJ-10 y RJ-11 con los conectores expuestos hacia usted, se numeran de 1 a 4 y de 1 a 6 de izquierda a derecha (v. fig.).

**conector RJ-10**



**conector RJ-11**

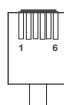

**Adaptador Dialogic® Diva® Analog-4:**

Todos los adaptadores Diva Analog-4 tienen cuatro puertos RJ-10 para conectar a cuatro accesos analógicos independientes. Los puertos se pueden usar indistintamente aunque, por regla general, es necesario especificar el número de puerto a la hora de configurar el software. Observe en la figura abajo los números de puerto. En la figura, el conector de enchufe del adaptador señala hacia abajo.



Conecte el adaptador Diva Analog-4 como se muestra en la figura:

**1. Utilice los cuatro cables suministrados y enchufe los cuatro conectores RJ-10 en el adaptador analógico.**

**Cajetín analógico o centralita**

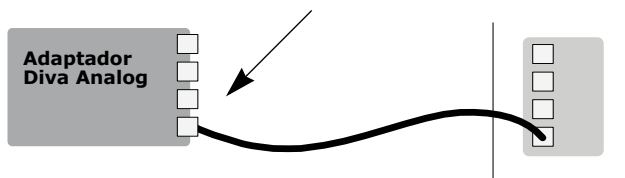

**2. Enchufe los cuatro conectores RJ-11 en el cajetín analógico o la centralita.**



Asignación de contactos:

RJ-10	Señal	RJ-11
Pin 2	Ring	Pin 3
Pin 3	Tip	Pin 4

**Nota:** Mirando los conectores RJ-10 y RJ-11 con los conectores expuestos hacia usted, se numeran de 1 a 4 y de 1 a 6 de izquierda a derecha (v. fig.).

**conector RJ-10**

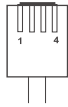

**conector RJ-11**



**Adaptador Dialogic® Diva® Analog-8:**

Todos los adaptadores Diva Analog-8 tienen cuatro puertos RJ-45 para conectar a cuatro dispositivos. Cada dispositivo tiene dos puertos. Así que un puerto del adaptador representa a dos puertos en el cajetín analógico o la centralita. Los puertos se pueden usar indistintamente aunque, por regla general, es necesario especificar el número de puerto a la hora de configurar el software. Observe en la figura abajo los números de puerto. En la figura, el conector de enchufe del adaptador señala hacia abajo.



**Puerto 1 y Puerto 2**

**Puerto 3 y Puerto 4**

**Puerto 5 y Puerto 6**

**Puerto 7 y Puerto 8**

Conecte el adaptador Diva Analog-8 como se muestra en la figura:

**1. Utilice los cables con dispositivo y enchufe los conectores RJ-45 en el adaptador analógico.**

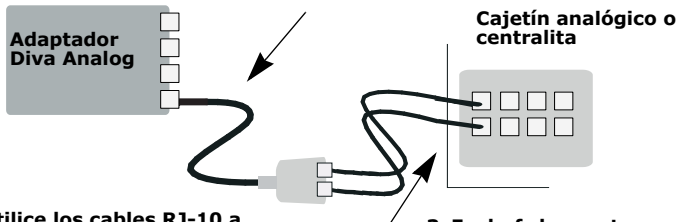

**2. Utilice los cables RJ-10 a RJ-11 y enchufe los conectores RJ-10 en el dispositivo. El puerto "A" corresponde a los puertos 1,3,5 y 7 en el cajetín analógico o la centralita. El puerto "B" corresponde a los puertos 2,4,6 y 8.**

**3. Enchufe los cuatro conectores RJ-11 en el cajetín analógico o centralita.**

Asignación de contactos:

RJ-45	Señal	Dispositivo con puertos RJ-10		RJ-11
Pin 1	Ring	puerto A	Pin 2	Pin 3
Pin 2	Tip		Pin 3	Pin 4
Pin 7	Tip	puerto B	Pin 3	Pin 4
Pin 8	Ring		Pin 2	Pin 3

**Nota:** Mirando los conectores RJ-45, RJ-10 y RJ-11 con los conectores expuestos hacia usted, se numeran de 1 a 8, de 1 a 4 y de 1 a 6 de izquierda a derecha (v. fig.)

conector RJ-45



conector RJ-10



conector RJ-11



### (C) Instalar el software para el adaptador Dialogic® Diva®

Para más información sobre la instalación del software para el adaptador Diva, consulte la documentación online que se encuentra con los drivers del software Diva System Release o en la página web de Dialogic en <http://www.dialogic.com/manuals/default.htm>.

Sistema operativo	Documentación
Todos los sistemas operativos Windows®	Dialogic® Diva® System Release WIN Reference Guide (inglés)
Linux®	Dialogic® Diva® System Release LIN Reference Guide (inglés)

## Problemas y Soluciones

La siguiente información le ayudará a diagnosticar y resolver problemas relacionados con el adaptador Dialogic® Diva® o su software. Si los consejos dados no son suficientes para solucionar un determinado problema, consulte la guía online o la ayuda online del software utilizado así como la ayuda que se ofrece en la web (véase la página 164).

### Comprobar la línea con Dialogic® Diva® Line Test

*(solamente para los sistemas operativos Microsoft® Windows®)*

El software Diva Line Test le permite comprobar la línea, el adaptador, el cableado y el enlace con la RDSI.

Para abrir el programa seleccione:

**Inicio > Programas > Dialogic Diva > Line Test.**

Diva Line Test le ofrece las siguientes pruebas:

- Line Check: Comprobación de la instalación del software Diva y la conexión física.
- Hardware: Comprobación de los controladores del adaptador.
- Phone/Loop: Envío y recibo de llamadas telefónicas para comprobar la línea.
- Call Transfer: Transferencias de llamadas, con la opción de seleccionar la manera de transferencia.
- Fax: Envío y recepción de facsímiles.

Para más información sobre Diva Line Test, véase la ayuda Dialogic® Diva® Line Test Online Help (DSLInetTest.chm).

## Comprobar los LEDs indicadores del estado

### Adaptadores Dialogic® Diva® BRI y Diva UM-BRI

Los adaptadores Diva BRI-CTI, Diva BRI-2FX, Diva BRI-2, Diva UM-BRI-2, Diva 4BRI-8 y Diva UM-4BRI-8 tienen dos LEDs por puerto (véase la figura):

Diva BRI-CTI  
Diva BRI-2FX  
Diva UM-BRI-2  
Diva BRI-2

Diva UM-4BRI-8  
Diva 4BRI-8

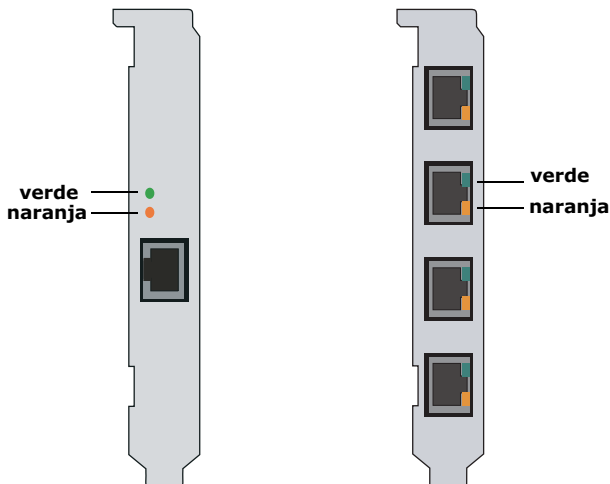

En la siguiente tabla se muestra la función de los LEDs:

Color	Estado	Descripción
verde	apagado	Nivel 1 inactivo.
	encendido	Nivel 1 activo. El cableado y el enlace con la RDSI son correctos.
naranja	apagado	Nivel 2, canal D, inactivo.
	encendido	Nivel 2, canal D, activo. En Europa el estado del canal D depende de la configuración del protocolo. El LED luce sólo mientras esté establecida la comunicación o de forma permanente.

## Adaptadores Dialogic® Diva® PRI y Diva V-PRI

Los adaptadores Diva PRI y V-PRI tienen cuatro LEDs (véase la figura):

Diva PRI 3.0  
Diva V-PRI  
Diva PRI PCIe

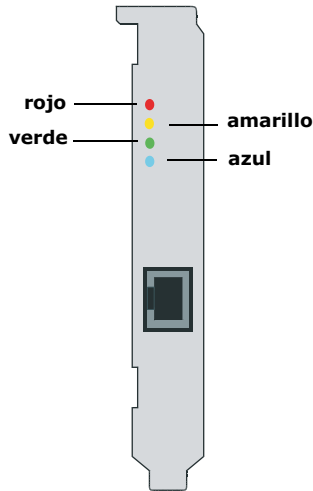

En la siguiente tabla se muestra la función de cada LED:

Color	Estado	Descripción
amarillo	apagado	Funcionamiento normal.
	encendido	La estación remota tiene problemas de sincronización (remote alarm / yellow alarm).
rojo	apagado	Funcionamiento normal.
	encendido	Al receptor no le llega ninguna señal (loss of signal / red alarm).
azul	apagado	Funcionamiento normal.
	encendido	Las tramas recibidas no están bien sincronizadas (alarm indication signal / blue alarm).
verde	apagado	Nivel 2 inactivo. Compruebe la configuración del nivel 2, es decir, el protocolo del canal D, la central telefónica, etc.
	encendido	Nivel 2 activo. El nivel 2 está activo siempre que el adaptador Diva PRI funcione correctamente.

## Adaptadores Dialogic® Diva® V-2PRI y Diva V-4PRI

Los adaptadores Diva V-xPRI PCI tienen dos LEDs multi funcionales por puerto (véase la figura):

Diva V-2PRI



Diva V-4PRI

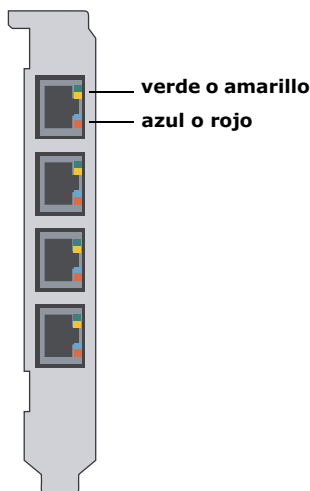

En la siguiente tabla se muestra la función de cada LED:

Color	Estado	Descripción
amarillo	apagado	Funcionamiento normal.
	encendido	La estación remota tiene problemas de sincronización (remote alarm / yellow alarm).
rojo	apagado	Funcionamiento normal.
	encendido	Al receptor no le llega ninguna señal (loss of signal / red alarm).
azul	apagado	Funcionamiento normal.
	encendido	Las tramas recibidas no están bien sincronizadas (alarm indication signal / blue alarm).
verde	apagado	Nivel 2 inactivo. Compruebe la configuración del nivel 2, es decir, el protocolo del canal D, la central telefónica, etc.
	encendido	Nivel 2 activo. El nivel 2 está activo siempre que el adaptador Diva PRI funcione correctamente.

## Adaptadores Dialogic® Diva® V-1PRI PCIe HS, V-2PRI PCIe HS y V-4PRI PCIe HS

Los adaptadores Diva V-xPRI PCIe HS tienen LEDs multi funcionales (véase la figura):

Diva V-1PRI PCIe HS  
Diva V-2PRI PCIe HS  
Diva V-4PRI PCIe HS

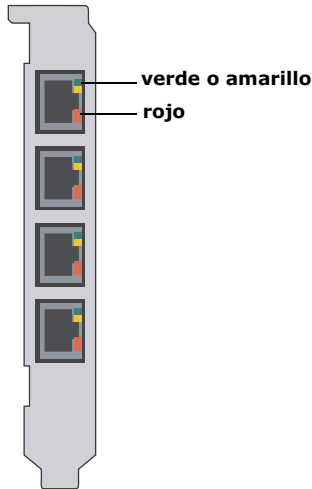

**Nota:** En los adaptadores Diva V-1PRI PCIe HS y Diva V-2PRI PCIe HS no todos los puertos son activados. Para más información véase la página 138.

En la siguiente tabla se muestra la función de cada LED:

Color	Estado	Descripción
amarillo	apagado	Funcionamiento normal.
	encendido	La estación remota tiene problemas de sincronización (remote alarm / yellow alarm).
rojo	apagado	Funcionamiento normal.
	encendido	Al receptor no le llega ninguna señal (loss of signal / red alarm).
verde	apagado	Nivel 2 inactivo. Compruebe la configuración del nivel 2, es decir, el protocolo del canal D, la central telefónica, etc.
	encendido	Nivel 2 activo. El nivel 2 está activo siempre que el adaptador Diva PRI funcione correctamente.

## Adaptadores Dialogic® Diva® V-4PRI PCIe FS y V-8PRI PCIe FS

Los adaptadores Diva V-xPRI PCIe FS tienen LEDs multi funcionales (véase la figura):

Diva V-4PRI PCIe FS

Diva V-8PRI PCIe FS

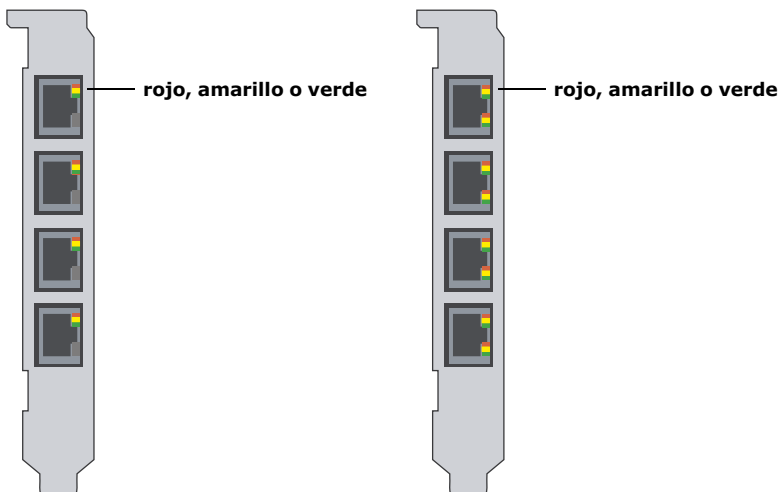

En la siguiente tabla se muestra la función de cada LED:

Color	Estado	Descripción
Todos los colores	apagado	El software no se ha inicializado.
verde	encendido	Carrier Sense (funcionamiento normal sin fallas)
amarillo	encendido	La estación remota tiene problemas de sincronización (remote alarm / yellow alarm).
	parpadeando lentamente	Blue alarm
rojo	encendido	Al receptor no le llega ninguna señal (loss of signal / red alarm).



## Datos Técnicos

### Condiciones de operacion:

- Temperatura de servicio: 10°C a 50°C
- Máx. fluctuación de voltaje admisible: según la especificación PCI (PCI/PCIe) correspondiente

	<b>Diva UM-BRI-2 Diva BRI-2</b>	<b>Diva UM-4BRI-8 Diva 4BRI-8</b>
Tipo de bus	PCI (3,3/5 V)	
Procesador	32 bits RISC CPU, 100 MHz	
Memoria en el adaptador	8 MB de SDRAM	16 MB de SDRAM
IRQs (Interrupt Request Level)	Asignado por la BIOS	
Direcciones básicas I/O (hex)		
Memoria compartida	8 MB	16 MB
DSPs	2 ADSP 2185	8 ADSP 2185
Dimensiones en mm (ancho x altura)		
PCB	167,65 x 64,41	174,63 x 106,68
Barra metálica de perfil bajo	181,36 x 80,06	
Barra metálica	180,96 x 120,88	187,84 x 126,37
Velocidad de transmisión de datos		
Canales B	2 x 64 kbits/s	4 x 2 x 64 kbits/s
Canales D	1 x 16 kbits/s	4 x 16 kbits/s
Plug&Play	sí	
Ahorro de energía		
Puerto	1 x RJ-45 (RDSI S <sub>0</sub> )	4 x RJ-45 (RDSI S <sub>0</sub> )
Interfaz físico	1 acceso RDSI S <sub>0</sub>	4 accesos S <sub>0</sub> paralelos
Consumo de energía	0,33 A @ +5 V típ.	0,58 A @ +5 V típ.

	<b>Diva UM-BRI-2 PCIe Diva BRI-2 PCIe</b>	<b>Diva UM-4BRI-8 PCIe Diva 4BRI-8 PCIe</b>
Tipo de bus	PCIe 1.0a x1 lane	
Procesador	32 bits RISC CPU, 100 MHz	
Memoria en el adaptador	64 MB de SDRAM	
IRQs (Interrupt Request Level)	Asignado por la BIOS	
Direcciones básicas I/O (hex)		
Memoria compartida	8 MB	16 MB
DSPs	2 ADSP 2185	8 ADSP 2185
Dimensiones en mm (ancho x altura)		
PCB	167,65 x 68,90	167,65 x 111,15
Barra metálica de perfil bajo	181,36 x 80,06	
Barra metálica	180,96 x 120,88	180,96 x 126,31
Velocidad de transmisión de datos		
Canales B	2 x 64 kbits/s	4 x 2 x 64 kbits/s
Canales D	1 x 16 kbits/s	4 x 16 kbits/s
Plug&Play	sí	
Ahorro de energía		
Puerto	1 x RJ-45 (RDSI S <sub>0</sub> )	4 x RJ-45 (RDSI S <sub>0</sub> )
Interfaz físico	1 acceso RDSI S <sub>0</sub>	4 accesos S <sub>0</sub> paralelos
Consumo de energía	0,27 A @ 3,3 V típ. 0,17 A @ 12 V típ.	0,42 A @ 3,3 V típ. 0,19 A @ 12 V típ.

	<b>Diva BRI-CTI Diva BRI-2FX</b>
Tipo de bus	PCI (3,3/5,0 V)
Procesador	32 bits RISC CPU, 133 MHz
Memoria en el adaptador	8 MB de SDRAM
IRQs (Interrupt Request Level)	Asignado por la BIOS
Direcciones básicas I/O (hex)	
Memoria compartida	8 MB
DSPs	ninguno
Dimensiones en mm (ancho x altura)	
PCB	167,65 x 64,41
Barra metálica de perfil bajo	181,36 x 80,06
Barra metálica	180,96 x 120,88
Velocidad de transmisión de datos	
Canales B	2 x 64 kbits/s
Canal D	1 x 16 kbits/s
Plug&Play	sí
Ahorro de energía	
Puerto	RJ-45 (RDSI S <sub>0</sub> )
Interfaz físico	1 acceso RDSI S <sub>0</sub>
Consumo de energía	0,3 A @ +5 V típ.

	<b>Diva V-PRI Diva UM-PRI Diva PRI 3.0</b>
Tipo de bus	PCI (3,3/5,0 V)
Procesador	32 bits RISC CPU, 300 MHz
Memoria en el adaptador	64 MB de SDRAM
IRQs (Interrupt Request Level)	Asignado por la BIOS
Direcciones básicas I/O (hex)	
Memoria compartida	8 MB
DSPs	2, 10 o 31 ADSP 2185 según el modelo
Dimensiones en mm	PRI/E1/T1-CTI, PRI/E1/T1-8:
PCB	174,63 x 106,68
Barra metálica	187,84 x 126,37
Dimensiones en mm (ancho x altura)	PRI/E1-30, V-PRI:
PCB	312,00 x 106,68
Barra metálica sin estribo de sujeción	325,31 x 126,37
Barra metálica y estribo de sujeción	352,17 x 126,37
Velocidad de transmisión de datos	
Canales B	23 o 30 x 64 kbits/s
Canal D	1 x 64 kbits/s
Plug&Play	sí
Ahorro de energía	
Puerto	RJ-45 (RDSI S <sub>2M</sub> )
Interfaz físico	1 acceso RDSI S <sub>2M</sub>
Consumo de energía	PRI/E1/T1-CTI: 0,58 A @ +5 V típ. 1,70 A @ +5 V máx. PRI/E1/T1-8: 0,65 A @ +5 V típ. 2,00 A @ +5 V máx. PRI/E1-30, V-PRI: 0,97 A @ +5 V típ. 2,70 A @ +5 V máx.

	<b>Diva V-PRI PCIe Diva UM-PRI PCIe Diva PRI PCIe</b>
Tipo de bus	PCIe 1.0a x1 Lane
Procesador	32 bits RISC CPU, 300 MHz
Memoria en el adaptador	64 MB de SDRAM
IRQs (Interrupt Request Level)	Asignado por la BIOS
Direcciones básicas I/O (hex)	
Memoria compartida	8 MB
DSPs	8 o 31 ADSP 2185
Dimensiones en mm (ancho x altura)	PRI/E1/T1-CTI PCIe:
PCB	167,65 x 68,90
Barra metálica de perfil bajo	181,38 x 80,06
barra metálica	180,96 x 120,88
Dimensiones en mm	PRI/E1-30 PCIe, V-PRI PCIe:
PCB	312,00 x 111,15
Barra metálica sin estribo de sujeción	325,31 x 126,31
Barra metálica y estribo de sujeción	352,17 x 126,31
Velocidad de transmisión de datos	
Canales B	30 x 64 kbits/s
Canal D	1 x 64 kbits/s
Plug&Play	sí
Ahorro de energía	
Puerto	RJ-45 (RDSI S <sub>2M</sub> )
Interfaz físico	1 acceso RDSI S <sub>2M</sub>
Consumo de energía	PRI/E1/T1 PCIe: 0,96 A @ +3,3 V típ. 0,04 A @ +12 V típ. PRI/E1-30 PCIe, V-PRI PCIe: 2,3 A @ +3,3 V típ. 0,03 A @ +12 V típ.

	<b>Diva V-2PRI PCI</b>	<b>Diva V-4PRI PCI</b>
Tipo de bus	PCI (3,3/5 V)	
Procesador	64 bits RISC CPU, 466 MHz	
Memoria en el adaptador	64 MB de SDRAM	
IRQs (Interrupt Request Level)	Asignado por la BIOS	
Direcciones básicas I/O (hex)		
Memoria compartida	8 MB	
DSPs	10 ADSP-BF533 (32 MB SDRAM)	20 ADSP-BF533 (32 MB SDRAM)
Dimensiones en mm (ancho x altura)		
PCB	312,00 x 106,68	
Barra metálica sin estribo de sujeción	325,31 x 126,37	
Barra metálica y estribo de sujeción	352,17 x 126,37	
Velocidad de transmisión de datos		
Canales B	2 x 23 x 64 kbits/s 0	4 x 23 x 64 kbits/s 0
	2 x 30 x 64 kbits/s	4 x 30 x 64 kbits/s
Canales D	2 x 64 kbits/s	4 x 64 kbits/s
Plug&Play	sí	
Ahorro de energía		
Puertos	2 x RJ-45 (RDSI S <sub>2M</sub> )	4 x RJ-45 (RDSI S <sub>2M</sub> )
Interfaz físico	2 accesos RDSI S <sub>2M</sub>	4 accesos RDSI S <sub>2M</sub>
Consumo de energía	3,0 A @ +3,3 V típ. 4,9 A @ +3,3 V máx. 0,02 A @ +5 V típ. 0,04 A @ +5 V máx.	5,5 A @ +3,3 V típ. 6,5 A @ +3,3 V máx. 0,04 A @ +5 V típ. 0,08 A @ +5 V máx.

	<b>Diva V-1PRI PCIe HS</b>	<b>Diva V-2PRI PCIe HS</b>	<b>Diva V-4PRI PCIe HS</b>
Tipo de bus	PCIe 1.0a x1 Lane		
Procesador	64 bits RISC CPU, 466 MHz		
Memoria en el adaptador	64 MB de SDRAM		
IRQs (Interrupt Request Level)	Asignado por la BIOS		
Direcciones básicas I/O (hex)			
Memoria compartida	8 MB		
DSPs	12 ADSP-BF533 (32 MB SDRAM)		
Dimensiones en mm (ancho x altura)			
PCB	167,65 x 111,15		
Barra metálica y estribo de sujeción	180,96 x 126,31		
Velocidad de transmisión de datos			
Canales B	1 x 23 x 64 kbits/s 0	2 x 23 x 64 kbits/s 0	4 x 23 x 64 kbits/s 0
	1 x 30 x 64 kbits/s	2 x 30 x 64 kbits/s	4 x 30 x 64 kbits/s
Canales D	1 x 64 kbits/s	2 x 64 kbits/s	4 x 64 kbits/s
Plug&Play	sí		
Ahorro de energía			
Puertos	1 x RJ-45 (RDSI S <sub>2M</sub> )	2 x RJ-45 (RDSI S <sub>2M</sub> )	4 x RJ-45 (RDSI S <sub>2M</sub> )
Interfaz físico	1 accesos RDSI S <sub>2M</sub>	2 accesos RDSI S <sub>2M</sub>	4 accesos RDSI S <sub>2M</sub>
Consumo de energía	0,91 A @ 3,3 V máx. 1,0 A @ 12 V máx.		

	<b>Diva V-4PRI PCIe FS</b>	<b>Diva V-8PRI PCIe FS</b>
Tipo de bus	PCIe 1.0a x4 Lane	
Procesador	64 bits RISC CPU, 466 MHz	
Memoria en el adaptador	128 MB de DDR2-SDRAM	
IRQs (Interrupt Request Level)	Asignado por la BIOS	
Direcciones básicas I/O (hex)		
Memoria compartida	8 MB	
DSPs	24 ADSP-BF533 (32 MB SDRAM)	
Dimensiones en mm (ancho x altura)		
PCB	312,00 x 111,15	
Barra metálica sin estribo de sujeción	325,31 x 126,31	
Barra metálica y estribo de sujeción	352,17 x 126,31	
Velocidad de transmisión de datos		
Canales B	4 x 23 x 64 kbits/s 4 x 30 x 64 kbits/s	8 x 23 x 64 kbits/s 8 x 30 x 64 kbits/s
Canales D	4 x 64 kbits/s	8 x 64 kbits/s
Plug&Play	sí	
Ahorro de energía		
Puertos	4 x RJ-45 (RDSI S <sub>2M</sub> )	8 x RJ-45 (RDSI S <sub>2M</sub> )
Interfaz físico	4 accesos RDSI S <sub>2M</sub>	8 accesos RDSI S <sub>2M</sub>
Consumo de energía	1,8 A @ 3,3 V típ. 1,5 A @ 12 V típ.	



	<b>Diva UM-Analog-2 Diva Analog-2</b>	<b>Diva UM-Analog-4 Diva UM-Analog-8 Diva Analog-4 Diva Analog-8</b>
Tipo de bus	PCI (3,3/5,0 V)	
Procesador	32 Bit RISC CPU, 100 MHz	
Memoria en el adaptador	16 MB SDRAM	
IRQs (Interrupt Request Level)	Asignado por la BIOS	
Direcciones básicas I/O (hex)		
Memoria compartida	16 MB	
DSPs	2 ADSP 2185	4 o 8 ADSP 2185 según modelo
Dimensiones en mm (ancho x altura)		
PCB	167,65 x 64,41	312,00 x 106,68
Barra metálica de perfil bajo	181,36 x 80,06	
Barra metálica	180,96 x 120,88	
Barra metálica sin estribo de sujeción		325,31 x 126,37
Barra metálica y estribo de sujeción		352,17 x 126,37
Velocidad de transmisión de datos	máx. 2, 4 u 8 x 56 kbits/s según el tipo de adaptador	
Plug&Play	sí	
Ahorro de energía		
Puertos	2 x RJ-10	todos los Analog-4: 4 x RJ-10 todos los Analog-8: 4 x RJ-45
Interfaz físico	2, 4, u 8 interfaces analógicas V.90 según el tipo de adaptador	
Consumo de energía	0,34 A @ +5 V típ.	todos los Analog-4: 0,45 A @ +5 V típ. todos los Analog-8: 0,5 A @ +5 V típ.

	<b>Diva UM-Analog-2 PCIe Diva Analog-2 PCIe</b>	<b>Diva UM-Analog-4 PCIe Diva UM-Analog-8 PCIe Diva Analog-4 PCIe Diva Analog-8 PCIe</b>
Tipo de bus	PCIe 1.0a x1 Lane	
Procesador	32 Bit RISC CPU, 100 MHz	
Memoria en el adaptador	16 MB SDRAM	
IRQs (Interrupt Request Level)	Asignado por la BIOS	
Direcciones básicas I/O (hex)		
Memoria compartida	16 MB	
DSPs	2 ADSP 2185	4 o 8 ADSP 2185 según modelo
Dimensiones en mm (ancho x altura)		
PCB	167,65 x 68,90	167,65 x 111,15
Barra metálica de perfil bajo	181,38 x 80,06	
Barra metálica	180,96 x 120,88	180,96 x 126,31
Velocidad de transmisión de datos	máx. 2, 4 u 8 x 56 kbits/s según el tipo de adaptador	
Plug&Play	sí	
Ahorro de energía		
Puertos	2 x RJ-10	todos los Analog-4: 4 x RJ-10 todos los Analog-8: 4 x RJ-45
Interfaz físico	2, 4, u 8 interfaces analógicos V.90 según el tipo de adaptador	
Consumo de energía	0,26 A @ 3,3 V típ. 0,16 A @ 12 V típ.	todos los Analog-4: 0,26 A @ 3,3 V típ. 0,18 A @ 12 V típ.  todos los Analog-8: 0,34 A @ 3,3 V típ. 0,22 A @ 12 V típ.

## Homologaciones internacionales

Los adaptadores Dialogic® Diva® están certificados en Europa (marca **CE**) y en Norteamérica (FCC e Industry Canada).

La certificación en Europa sólo es válida para los países que aceptan la marca de la Unión Europea (marca **CE**): Alemania, Austria, Bélgica, Chipre, Dinamarca, Eslovaquia, Eslovenia, España, Estonia, Finlandia, Gran Bretaña, Grecia, Holanda, Irlanda, Islandia, Italia, Latvia, Lituania, Luxemburgo, Noruega, Polonia, Portugal, República Checa, Suecia y Suiza.

Algunos países de Europa Oriental y del Mediterráneo también aceptan la marca CE. Si no está seguro, consulte con su proveedor, con la compañía telefónica o con la Oficina de Homologaciones.

Si necesita más información sobre la homologación, veáse la página web: <http://www.dialogic.com/declarations>.

## Soporte Técnico

Dialogic ofrece diferentes posibilidades de obtener soporte técnico para su producto de Dialogic. Le recomendamos que primeramente utilice los programas de soporte de Dialogic® Diva® antes de consultar con su proveedor de Dialogic. También le recomendamos que visite la la página web de servicio y soporte técnico (en inglés). En el supuesto de que usted no pudiera resolver el problema, consulte con el soporte técnico de Dialogic.

Para más información vea:

- [Programas de soporte de Dialogic® Diva®](#) abajo
- [Página web de Dialogic Services & Support](#) abajo
- [Soporte técnico de Dialogic](#) en la página 165

### Programas de soporte de Dialogic® Diva®

Si un problema ocurre durante la operación de su producto Dialogic® Diva®, utilice los siguientes programas de soporte en inglés (solamente para sistemas operativos Windows®):

- Dialogic® Diva® Line Test: Con este programa puede verificar su adaptador y realizar llamadas de prueba, transferencia de llamadas y llamadas entrantes y salientes.
- Dialogic® Diva® Diagnostics: Con este programa puede guardar mensajes de seguimiento para cada adaptador o controlador en un archivo.
- Dialogic® Diva® Management tool: Con este programa puede ver el status actual de las líneas conectadas, de las conexiones activas y la historia de la conexiones.

Para más información sobre los programas véa la ayudas online correspondientes.

Si no puede resolver el problema con la ayuda de estos programas, contacte a su proveedor de Dialogic.

### Página web de Dialogic Services & Support

En el caso de que su proveedor no puede localizar la causa del error, visite nuestra página web "Services &Support" en inglés. La página contiene:

- información detallada sobre el servicio Dialogic® Pro™ Service (contratos de servicio 24/7 por uno, tres o cinco años):  
<http://www.dialogic.com/support/DialogicPro/>
- información sobre la ayuda web para muchos productos de Dialogic:  
<http://www.dialogic.com/support/helpweb>
- una página para bajar la versión más actual de su software:  
<http://www.dialogic.com/support/downind.asp>

- información sobre entrenamientos en línea, en las oficinas de Dialogic o en su oficina: <http://www.dialogic.com/training/default.htm>
- una referencia a la página con la documentación de los diferentes productos: <http://www.dialogic.com/manuals/default.htm>
- foros técnicos: <http://www.dialogic.com/forums/category-view.asp>
- información sobre la página del soporte técnico. Para más información sobre como contactarlo, véase la siguiente sección.

## Soporte técnico de Dialogic

Si tiene problemas con el adaptador Dialogic® Diva® y el software, lea detenidamente las sugerencias y recomendaciones dadas en la Ayuda Web antes de ponerse en contacto con el soporte técnico.

El soporte técnico podría necesitar:

- un seguimiento de depuración. Para más información consulte la ayuda online Dialogic® Diva® Diagnostics Online Help (DivaTrace.chm) para los sistemas operativos Windows®, y el Dialogic® Diva® System Release LIN Reference Guide para Linux.
- o para los sistemas operativos de Windows® una copia de la configuración activa. Para más información consulte la ayuda online Dialogic® Diva® Configuration Manager Online Help (DSMain.chm).

Para obtener información sobre como contactarnos según el producto y el problema que tenga, por favor visite: [www.dialogic.com/support/contact](http://www.dialogic.com/support/contact).

## Información Medioambiental Para Su Producto

En agosto de 2005, entraron en vigor en casi todos los países de la Unión Europea la directiva UE (2002/96/EC) y su enmienda (2003/108/EC), denominadas RAEE, destinadas a atenuar el impacto de los residuos de aparatos eléctricos y electrónicos en el medio ambiente. Este producto Dialogic cumple con la directiva Directiva RAEE.

Confiamos en que este producto ofrecerá un servicio duradero y fiable. Cuando el mismo ya no satisface sus necesidades o los costes de reparación fueran demasiado altos, solicitamos su cooperación para reciclar este producto conforme a la directiva RAEE.

Dado que Dialogic ha tomado todas las precauciones necesarias para minimizar la carga medioambiental de este producto a través de su diseño y su fabricación, le solicitamos que nos ayude a minimizar la huella medioambiental de este producto reciclándolo.

Por favor, no elimine este producto en vertederos de residuos municipales o generales, puesto que contiene materiales que pueden recuperarse y reciclarse.

Como todo equipamiento electrónico y eléctrico, incluyendo televisiones y ordenadores, este producto puede contener pequeñas cantidades de materiales que podrían ser dañinos para el medio ambiente. A fin de minimizar dichos daños, le solicitamos que recicle este producto:

- depositándolo en la plataforma ecológica de su empresa,
- llevándolo a la tienda donde ha adquirido el equipo de reemplazo,
- enviándolo al centro de mantenimiento de su zona de ubicación.

Este servicio es gratuito, puesto que Dialogic ya ha pagado el reciclado del producto en el momento del lanzamiento en el mercado, como lo requiere la directiva RAEE.





